



ECC Report 234

Analyses of LDC UWB mitigation techniques with respect to incumbent radiocommunication services within the band 3.1 to 3.4 GHz

Approved May 2015

0 EXECUTIVE SUMMARY

This report is based on concerns from some administrations that the regulatory provisions established in Annex 2 of ECC/DEC/(06)04 [1] for LDC UWB applications might be not entirely adequate to ensure protection of the radiodetermination service, especially the primary allocated radiolocation service in the band 3.1 – 3.4 GHz. The aim of this report is to analyse if there is any evidence of potential harmful interference from LDC UWB devices to radar systems operating in the band 3.1-3.4 GHz.

The protection criterion I/N of -6 dB and -10 dB are used, with the latter as more conservative assumption than in the ITU-R M.1465-1 [10] which recommends a protection objective of I/N -6dB.

For the assumed rural deployment density of 100 LDC UWB devices per km² with activity factors of 1 to 10% and under the actual LDC parameter regulation (1% to 10% main beam overlap probability) the number of interfered beams per rotation statistically varies between 0.06 and 28.9 for an I/N of -6 dB (0.17 to 71 for I/N of -10 dB).

Practically that means for an I/N of -6 dB on the lower end that every 17th rotation (roughly every 3 minutes) one overlap will occur and on the upper end 29 beams per rotation (one overlap each 0.4 seconds) will see an overlap.

The above results are based on the assumptions that all LDC UWB devices are in LOS to the radar. The report assumes that the overlap probability can be treated as an interference probability, e.g. that any overlap in time with the radar main beam is causing an interference.

It should be noted that the choice of I/N disregards the mitigating effects of improved self-resistance against interference implemented in modern radar system design by using advanced digital signal processing techniques (processing gain, phase sensitive detection, auto-correlated filtering, Moving Target Detection and tracking, Constant False Alarm Rate detection, etc.).

For radar systems with a CFAR detector a noise-like interference may either cause a higher false alarm rate or lead to a reduced radar sensitivity resulting in a reduced detection range. That means that low RCS targets at maximum instrumented range will no longer be detected.

It was not possible to determine in a general way whether the interference will be seen as harmful as this depends on the processing capabilities of an individual radar.

0 EXECUTIVE SUMMARY	2
1 INTRODUCTION.....	5
2 DEFINITION OF LDC AND TECHNICAL PARAMETERS OF LDC UWB DEVICES	7
2.1 Time related parameters	7
2.2 Peak Power, Mean Power.....	8
2.3 LDC UWB Parameters for the compatibility studies	8
3 OVERVIEW OF EXISTING STUDIES	10
3.1 the impact of LDC UWB devices on Radiolocation SERVICE in the band 3.1-3.4 GHz (2008)	10
3.2 the impact Of LDC UWB devices on WIMAX (April 2011)	10
3.3 Trading power and DC for LDC UWB (June 2012).....	11
3.4 Generic impact of LDC mitigation on Communication Services using digital modulations.....	12
4 STUDIES WITH RADIOLOCATION SERVICE 3.1-3.4 GHZ.....	13
4.1 Parameters of the Radiolocation services	13
4.2 Protection criteria and Quality of service OF Radars.....	14
4.3 Estimation of the number of active LDC UWB devices per radar mainbeam	14
4.4 Analytical time domain calculations	16
4.5 Time domain Simulations with Matlab.....	19
4.5.1 Time Domain simulation results for a single azimuth sector	20
4.5.2 Time Domain simulation results for all azimuth sectors	22
4.6 Summary Radiolocation	27
5 CONCLUSIONS.....	29
ANNEX 1: DESCRIPTION OF TIME-DOMAIN SIMULATION	30
ANNEX 2: ACTIVE DEVICES PER MAINBEAM	32
ANNEX 3: LIST OF REFERENCES	35

Abbreviation	Explanation
AF	Activity Factor
CEPT	European Conference of Postal and Telecommunications Administrations
C/I=CIR	Carrier to interference Ratio
CW	Continuous Wave
CFAR	Constant false alarm rate
DC	Duty Cycle
DCT	Duty Cycle Template
ECC	Electronic Communications Committee
ETSI	European Telecommunications Standards Institute
FAR	False Alarm Rate
FWA	Fixed Wireless Access
ILT	Interfering Link Transmitter
I/N=INR	Interference to Noise Ratio
LAES	Location Tracking Application for Emergency Services
LDC	Low Duty Cycle
LT	Location Tracking
LT2	Location Tracking Type 2
PSD	Power Spectral Density
Pd	Probability of Detection
QoS	Quality of Service
RCS	Radar Cross Section
Toff	Time the transmission is switched off
Ton	Time the transmission is switched on
UWB	Ultra Wide Band
WiMAX	FWA technologies

1 INTRODUCTION

This report is based on concerns from some administrations that the regulatory provisions established in Annex 2 of ECC/DEC/(06)04 [1] for LDC UWB applications might be not entirely adequate to ensure protection of the radiodetermination service, especially the primary allocated radiolocation service in the band 3.1-3.4 GHz. The aim of this report is to analyse if there is any evidence of potential harmful interference from LDC UWB devices to radar systems operating in the band 3.1-3.4 GHz.

The LDC limits provided in Annex 2 of ECC/DEC/(06)04 [1] were originally derived from ECC Report 94 [6], where only the impact of single LDC UWB devices on FWA / Wimax was investigated through practical measurements in the band 3.4-4.8 GHz. A still open question is the effectiveness of the LDC mitigation technique in case of an aggregate scenario with multiple LDC UWB devices affecting the radiolocation service.

The considering part of ECC/DEC/(06)04 [1] contains a useful background material to the UWB regulation. Especially considerings w and x are worth to be mentioned here:

- *Considering w, that based on studies and measurement campaigns on the impact of LDC UWB devices on radars in the band 3.1-3.4 GHz, it was concluded in 2008 that the probability of a single LDC UWB device to radiate into the main beam of the radar was low and hence the risk of harmful interference was considered to be small;*
- *Considering x, that one study showed that aggregation effects from LDC UWB devices on radars could cause unacceptable probability of interference in the band 3.1 - 3.4 GHz. However, the various regulatory provisions aiming to minimise outdoor use could be sufficient to reduce the aggregate interference;*

This report aims to assess the impact of LDC UWB devices operating according to ECC/DEC/(06)04 [1] on the radiolocation Service in the band 3.1 to 3.4 GHz.

The assessment is done by applying some new analytical approaches as well as taking into account some background material and relevant parameters and methods available from previous studies, most notably ECC Report 94 [6], ECC Report 170 [5] and CEPT Report 45 [8].

The below figure gives an overview of LDC related work in CEPT and ETSI.

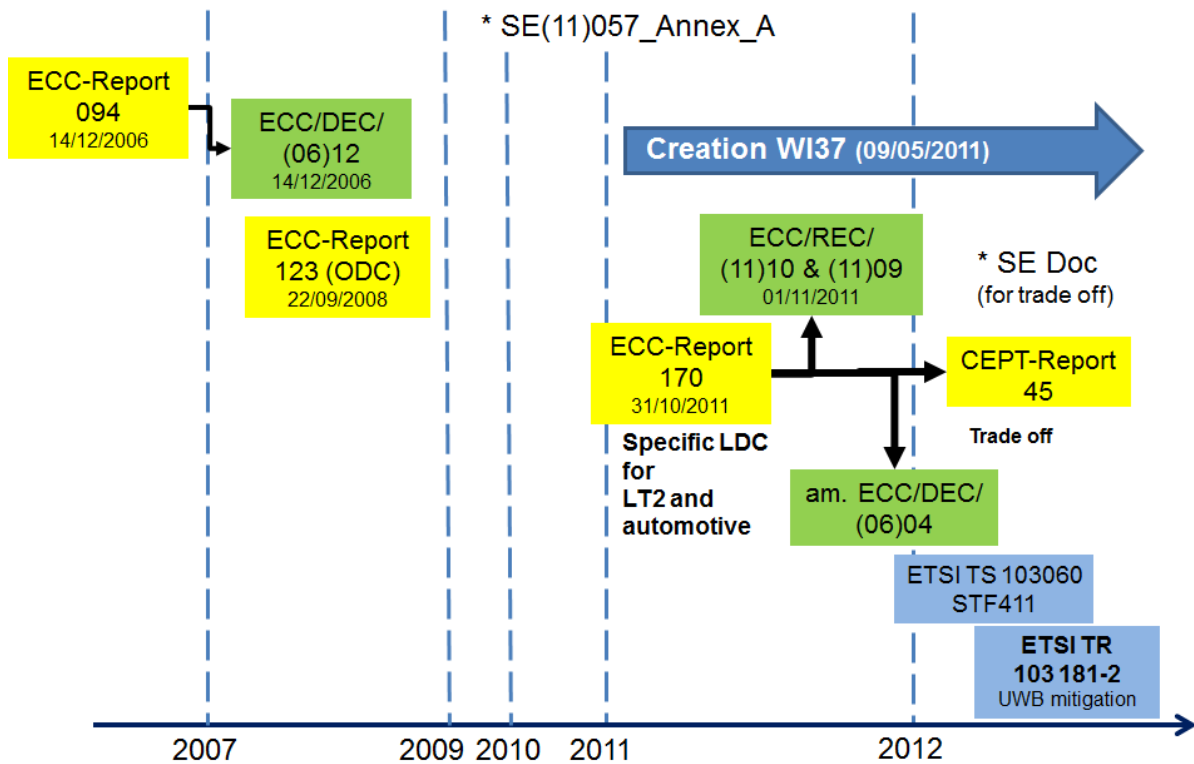

Figure 1: LDC UWB history

It is important to note in this regard that part of the studies of this report considered interference effects between LDC UWB and radars in time domain, where there are no generic analysis methods nor commonly agreed acceptance rules established within CEPT. Therefore a dedicated analysis approach was developed in this report to address the specific coexistence scenario. In recent CEPT compatibility studies of UWB technologies, the simulations and model developments and measurements concentrated on evaluating the victim's Quality of Service (QoS) to decide whether to accept or not accept certain LDC parameter sets and ILT (Interfering Link Transmitter) transmit power values. The LDC mitigation effect is proven (calculated and measured) for victim devices operating in the communication service.

2 DEFINITION OF LDC AND TECHNICAL PARAMETERS OF LDC UWB DEVICES

2.1 TIME RELATED PARAMETERS

There exist different definitions of time related parameters (e.g. Duty Cycle, Activity Factor, Ton, Toff) in different reports, standards etc, which are context dependent. Therefore those different contexts may need to be kept in mind when comparing the findings of different prior studies.

Regarding the LDC mitigation technique for UWB devices, the key time related parameters had been established in Annex 2 of ECC/DEC/(06)04 [1]:

- $T_{on\ max} = 5\ ms$;
- $T_{off\ mean} \geq 38\ ms$ (averaged over 1 sec);
- $\sum T_{off} > 950\ ms$ per second;
- $\sum T_{on} < 18\ s$ per hour (dependent on the speed for vehicle mounted devices) .

The meaning of the key reference parameters being defined in ECC/DEC/(06)04 [1] as follows:

- T_{on} : duration of a burst irrespective of the number of pulses contained;
- T_{off} : time interval between two consecutive bursts when the UWB emission is kept idle.

ETSI TS 103 060 [2] introduces a Duty Cycle Template (DCT) transmission as a passive mitigation technique used by SRDs. It explains the concept of the Duty Cycle template and possible measurement procedures to measure the timing requirements (e.g. Ton and Toff). The main definitions are given below:

- DCT consists of an active transmission interval followed by an inactive idle interval. The combination of these two provides the basis of the mitigation technique to share spectrum.
- Duty Cycle (DC) is a signal property that is the time spent in an active state as a fraction of the total time under consideration. DCT differs from DC by generalizing the definition of a transmission to include operation over a defined observation bandwidth and defined observation time, as they affect the systems under consideration and harmonizing Ultra Wideband and non-Ultra Wideband systems treatment.
- As a result, the DCT requirement should define limits on individual transmission parameters in such a way as to avoid harmful interference to victim system receivers even if they are simultaneously operated in close physical proximity and in the same radio spectrum bandwidth at the same time.
- Differences between DC/DCT/LDC and Activity Factor: DC/DCT/LDC is related to the signal from the device and cannot be changed by the user; Activity Factor is a user / system related parameter, e.g. by number of uses per day.

A second relevant ETSI deliverable is ETSI TR 103181-2 [3]. This report is the second part of a three-part report on UWB:

- Part 1: different UWB signal and UWB regulations in CEPT/EC (actual under preparation);
- Part 2: UWB mitigation techniques (published June 2014);
- Part 3: Status UWB regulation worldwide (actual under preparation) .

Reference [3] offers a summary of all mitigation techniques which are used for UWB in the different regulations in CEPT and EC. For the LDC mitigations the report shows the details and differences of the regulated parameters between UWB Generic, in vehicular use, location tracking, BMA, ODC and (tank) level probing applications.

However the studies in this report have considered only the LDC UWB limits from Annex 2 of ECC/DEC/(06)04 [1] as reiterated above; the abbreviation "LDC UWB" is used.

2.2 PEAK POWER, MEAN POWER

ECC Report 64 [4] shows that under specific conditions (see ECC Report 64, section 4.3) the impact of UWB waveforms can be treated noise-like at narrowband victim link receivers mainly resulting in an increase of the noise floor. Consequently only the mean power is relevant for the technical studies and not the peak power. The studies in this report only consider the mean power of UWB.

2.3 LDC UWB PARAMETERS FOR THE COMPATIBILITY STUDIES

Table 1 gives an overview of UWB deployment parameters used in existing CEPT deliverables.

Table 1: Overview of existing UWB deployment parameters

UWB application	Generic UWB	BMA	ODC	LAES	LT2	Automotive
ECC Regulation	ECC/DEC/(06)04	ECC/DEC/(07)01		ECC/REC/(11)10	ECC/REC/(11)09	ECC/DEC/ (06)04
ECC Reports	ECC Report 64 [4]	ECC Report 123 [11]		ECC Report 170 [5]		
Densities rural/ suburban/ dense urban per km ² values for in and outdoor	100/ 1000/ 10000	0.052/ 0.46/ 6.7	0.3/ 2.5/ 19	Details see ECC Report 170 Annex 1 Average density of event/km ² : 0.008	See ECC Report 170 Chapter 3.2	Sensors per car 3.4 to 4.8GHz: 6 with LDC of 5%/s o Vehicle speed >20km/h: long term LDC: 5%/h o Vehicle speed <20km/h: long term LDC: 0.5%/h 6 to 8.5 GHz: 4 UWB; with LDC of 5%/s and 0.5%/h Vehicle density: o Sub Urban case: 330/km ² o Rural case: 100/km ²
Aggregated Activity Factor per 12h	1%	0.28%	between 1.4% and 3%			
Density of active devices rural/ suburban /dense urban per km ²	1/ 10/ 100	0.00015/ 0.0013/ 0.019	0.004 0.049 0.563	Active device is: 1	See ECC Report 170 [5] Chapter 3.2	

The values from Table 1 were used as guidance for developing UWB deployment scenarios for this report. Table 2 summarises the parameters used in this report.

Table 2: Assumptions for LDC UWB in rural scenario to be used for studies with the radiolocation service in the band 3.1-3.4 GHz

	Outdoor ratio	Number of devices / km ²	Power	LDC limit	AF (Device) Note 3
Generic usage	5%	1 -100	-41.3 dBm/MHz e.i.r.p Wall attenuation: mean 10dB (Note 2)	5%/s 0.5%/h Ton: ≤ 5 ms Toff mean: ≥ 38 ms	1 -10 %
Vehicle	100%	1 – 100 vehicles 1 Sensor per vehicle Note 1	-41.3 dBm/MHz e.i.r.p Exterior limit: -53.3 dBm/MHz e.i.r.p.	5%/s 0.5%/h Ton: ≤ 5ms Toff mean: ≥ 38ms	1-10 %

Note 1: 1 sensor per vehicle has been assumed although ECC/DEC/(06)04 [1] mentions in considering II that 6 sensors could be possible; this is based on the assumption that the main vehicular applications are working above 3.4 GHz, because only there the increased DC of 5% per h is possible.

Note 2: 10 dB has been used in ECC Report 64 [4].

Note 3: the Activity Factor (AF) is the percentage of a single device switched on.

Concerning Note 3 of the above table, in this report it will be assumed that with a uniform distribution of the AF in time this AF may be equivalent to the percentage of simultaneously active devices and will be used as such.

3 OVERVIEW OF EXISTING STUDIES

3.1 THE IMPACT OF LDC UWB DEVICES ON RADIOLOCATION SERVICE IN THE BAND 3.1-3.4 GHz (2008)

During the ECC TG3 study period two measurement campaigns and one theoretical study were carried out (see [15], [16], [17]). The aim of these investigations was to assess the improvement of the protection of the radiolocation service by implementing Low Duty Cycle (LDC) mitigation technique on UWB devices.

The results from those three studies are summarized below:

- The investigation of the probability of interference by carrying out SEAMCAT simulations, as reported in [15] from one Administration, comes to the conclusion that the operation of LDC UWB devices is compatible with radars in the frequency range 3100 - 3400 MHz under the assumption of indoor use.
- A first measurement campaign provided by one Administration [16] confirms the need for maximum mean e.i.r.p. spectral density of -70dBm/MHz for generic UWB in this band. It also shows that the LDC UWB solution improves the situation. In particular, the LDC emission makes jamming strobes disappear compared to continuous emissions. The first test report concluded that no interference has been observed with LDC UWB devices and that their use must be strictly limited to indoor conditions. It should be noted that the above considerations are the conclusions taken from [16], which was an input contribution from one administration and not an agreed study from ECC TG3.
- A second measurement campaign provided by another Administration in [17] concluded that a single outdoor LDC UWB device has nearly the same impact on the radar performance as a UWB device without LDC for the case of non-rotating radar. Under this assumption of fixed main-beam, LDC is not considered as an appropriate mitigation technique for radar waveform single entry interference. One reason is that the Ton time is higher than the PRI of the radar leading to the corruption of more than one single pulse measurement. It is expected that this degradation starts earlier than the above mentioned radar performance since the detection process recovers received radar echo signals even below the noise level (matched filter processing). Also, due to the layout of that particular measurement campaign any influence of the LDC UWB device with rotating radar antenna was not measurable (this was not part of the evaluation). During the part with rotating antenna no indications on the operator PPI screen were observed for several minutes. However, to measure such an interference scenario it would be needed to evaluate several hours of radar operation.

The majority of the CEPT administrations then supported ECC/DEC/(06)04 [1] provisions that allow LDC UWB to operate in the band 3.1-3.4 GHz with a maximum mean e.i.r.p. spectral density of -41.3 dBm/MHz under LDC timing restrictions, as it was considered that the probability of a single device to radiate into the main beam of the rotating radar antenna is negligible. Some administrations did not support the allowance of LDC in the band 3.1-3.4 GHz due to the safety of life mission of the radiolocation service for which the assumed probability of interference is not negligible. Additionally they stressed that there was no clear documentation about the impact of LDC devices to the Radiolocation Service, which does not allow Administrations to verify the conclusions.

The above situation at the time of approval of the LDC UWB rules was one reason to trigger the studies in this report. Accordingly the impact of LDC UWB on the Radiolocation Service will be analysed in detail in section 4.

3.2 THE IMPACT OF LDC UWB DEVICES ON WiMAX (APRIL 2011)

The LDC UWB limits from Annex 2 of ECC/DEC/(06)04 [1] were derived from ECC Report 94 [6]. ECC Report 170 [5] contains some further studies dealing with the impact of LDC on WiMAX investigating the feasibility to increase the Ton time from 5 ms to 25 ms for LT2 UWB devices. The results (see section 3.3.1 of ECC Report 170 [5]) indicated that a max Ton time of 25 ms has less impact on WiMAX as 5ms, which is the current limit for LDC in ECC/DEC/(06)04 [1]. The study provided in

addition the impact of very small Ton times down to 10 μ s and here the results were also not in line with the LDC rules in ECC/DEC/(06)04 [1], because they show that the impact increases with smaller Ton times. These results, which are valid for WiMAX at 3.5 GHz, compare with the LDC rules from ECC/DEC/(06)04 as shown in Table 4.

Table 3: Comparison of different LDC values

LDC definition from ECC/DEC/(06)04 [1]	LDC definition found suitable for UWB LT2 and LAES applications
Ton <= 5ms	5 ms <Ton <= 25 ms

Since these results were derived for specific UWB applications operating in specific frequency band, they were not considered for amending Annex 2 of ECC/DEC/(06)04 [1], but instead were reflected in ECC/REC/(11)09 [7] and ECC/REC/(11)10 [12], which were made to guide deployment of UWB LT2 and LAES applications.

3.3 TRADING POWER AND DC FOR LDC UWB (JUNE 2012)

The possibility to increase for automotive UWB applications the LDC limit when reducing the Tx power was discussed in CEPT in 2012 and 2013.

The main proposal was to permit higher DC limits together with a reduced PSD limit. Table 4 below shows the limits of ECC/DEC/(06)04 [1] for automotive applications (green) and the proposal with lower PSD and higher LDC values.

Table 4: Trade-off of PSD vs LDC proposed in 2012 study

PSD limit	External limit Elevation > 0°	Long Term Duty Cycle	Short Term Duty Cycle	Max (Ton)	Mean (Toff)	Max [Σ Ton]	Min [Σ Toff]
dBm / MHz	dBm / MHz	Seconds in 1 hour	% in 1 second	Milliseconds	Milliseconds	Milliseconds	Milliseconds
-41.3	-53.3	18-180	5.0%	5.0	38.0	50.0	950.0
-44.3	-56.3	36-360	10.0%	10.0	38.0	100.0	900.0
-47.3	-59.3	72-720	20.0%	20.0	38.0	200.0	800.0
-50.3	-62.3	144-1440	40.0%	40.0	38.0	400.0	600.0
-51.3	-63.3	180-1800	50.0%	50.0	38.0	500.0	500.0

CEPT Report 45 [8] (Section 3.1.1 and Annex 2) summarised the main findings about trading of power and Duty cycle for LDC UWB applications. It concluded that trading of LDC against transmitted power as shown in

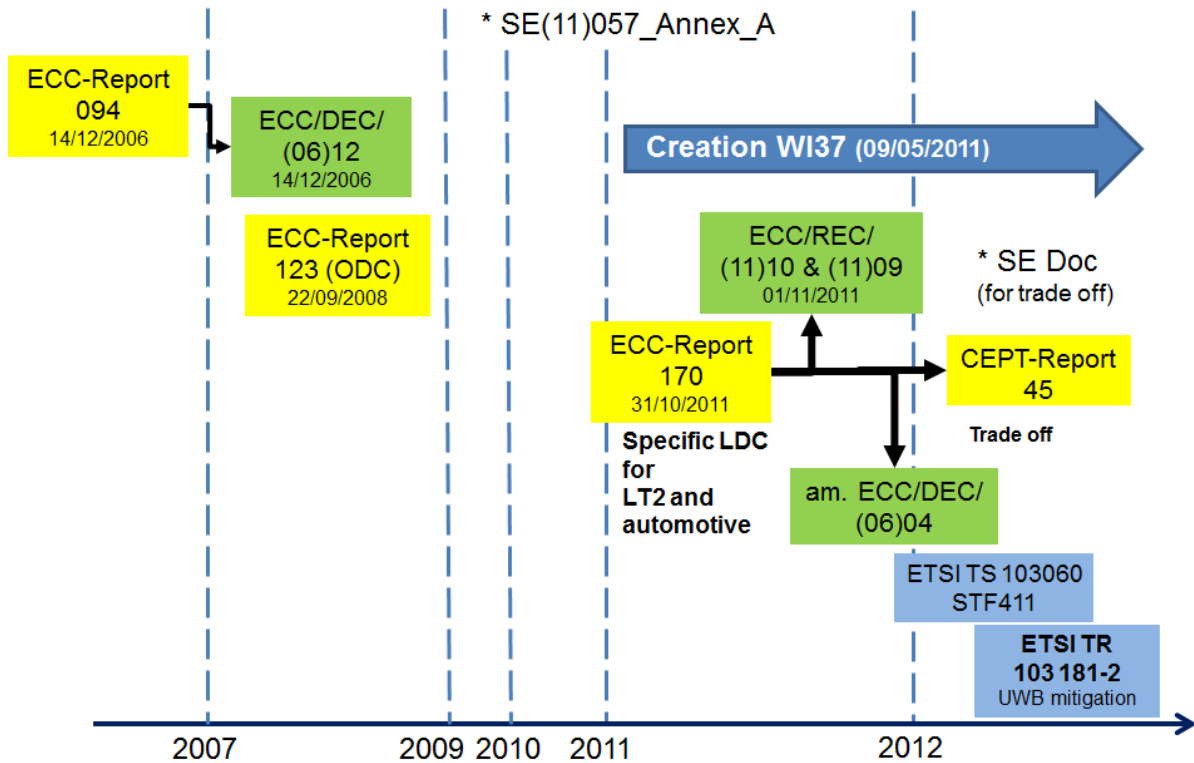

Figure 1 above and within these boundaries only is considered to provide equivalent protection to the LDC limits stated in ECC DEC(06)04 [2] as amended in 2011.

The above conclusion is not necessarily applicable to other situations. In general duty cycle and power have different effects and a change in one cannot be exactly countered by a change in the other. There are only a few cases in which the effects are equivalent and some trading off between them can be made. The LDC UWB case appears to be one of those special cases because a victim receiver experiences the interference purely as a noise level.

The above considerations on trading between power and DC are only applicable to automotive UWB applications with speed above 40 km/h in the bands 3.4-4.8 and 6-8.5 GHz according to Annex 2 of ECC/DEC/(06)04 [1], and not for the band below 3.4 GHz.

3.4 GENERIC IMPACT OF LDC MITIGATION ON COMMUNICATION SERVICES USING DIGITAL MODULATIONS

ECC Report 170 [5] shows in section 3.3.4.3 studies on the impact of LDC UWB devices on the Fixed Service and other radio systems. In particular the possibility to minimise the impact by a reduction of the peak power was analysed. ECC Report 170 [5] concluded based on measurements and analytical calculations in the following way:

- A 10dB peak power reduction (-41dBm/MHz mean e.i.r.p. and -10dBm/50MHz peak e.i.r.p.) may reduce the impact on the radio systems, but not in all cases
- For measurements with UMTS, DVB-T and DVB-S there was no discernible mitigation.
- For WLAN there was a small positive effect observed

The positive effect of the peak power reduction on the FS shown in ECC Report 158 (measurements and simulations) and in Annex 2 of ECC Report 170 [5] could be explained by the fact that those studies not considered error corrections employed by victim systems. If the error corrections would have been considered in these studies, the impact of the peak power reduction could be less pronounced, because also the overall base impact of UWB on the FS would be smaller in that case.

4 STUDIES WITH RADIOLOCATION SERVICE 3.1-3.4 GHZ

The aim of this chapter is to assess the impact of LDC UWB devices on the radiolocation service in the frequency band 3.1 to 3.4 GHz.

Previous analysis of LDC mitigation from UWB was primarily based on results of practical measurements, such as to WiMAX as representative FWA technology in the band 3.4-3.8 GHz [6]. This previous analysis will be now complemented by studying possible interference from a number of LDC UWB devices spread over the area surrounding the victim radar.

For this task the parameters of a representative radar system are given in section 4.1 and the protection criteria identified in section 4.2.

Three different calculation/simulation approaches are possible to assess the interference probability:

1. Pure time domain calculations and simulations, which assume that interferer's signals are always received/discerned by victim receiver above ambient noise;
2. Frequency/spatial simulations to evaluate conditions for frequency overlap and probability of exceeding C/I or I/N threshold by accounting for path loss on interference coupling link;
3. Combined time domain, frequency and spatial simulations.

This report uses basically the first approach with time domain calculations and simulations. The overlapping probability between interferer transmits and victim receives time slots are shown in sections 4.4 and 4.5. The number of active LDC UWB devices as most important input parameter to the time-domain analysis was derived with a simplified MCL analysis in section 4.3. Consecutively, this time-domain overlap probability can be considered as the interference probability, on the pessimistic assumption that any interfering signal overlapping in time with the mainbeam of the radar antenna will cause a harmful interference.

The second and third approach (frequency/space and combined time/frequency/space) were not considered in this report.

For the following time domain considerations, it will be assumed that interference can only occur if the interfering LDC UWB device is in the main beam of the radar and the LDC UWB device is transmitting and the radar receiver is searching for target reflections (radar receiver's ON time period).

4.1 PARAMETERS OF THE RADIOLOCATION SERVICES

The following set of radiolocation system parameters is used for the calculations in this document.

Table 5: Table of chosen relevant characteristics of radiolocation systems for this report

Parameter	Chosen value
Frequency (GHz)	3.1
Pulse width (μ s)	20
Repetition rate (kHz)	0 (single pulse)
Antenna gain (dBi)	42
Antenna type	Parabolic
Beamwidth (H,V) (degrees)	1.1 / 2.2
Vertical scan type	10 stepped elevation beams
Horizontal scan type	Rotating

Parameter	Chosen value
Maximum horizontal scan (degrees)	360
Horizontal scan rate (degrees/s)	30
Rx sensitivity (dBm)	-112
Rx noise figure (dB)	2
Rx RF bandwidth (MHz) (-3 dB)	1 MHz

4.2 PROTECTION CRITERIA AND QUALITY OF SERVICE OF RADARS

It should be noted that a time domain protection criterion for the radiolocation service is not available. Concerning the Quality of Service of radars, the main parameter is the detection range. This parameter cannot be viewed isolated but is always connected to a certain minimum target reflectivity (RCS) and the probability of detection (Pd). These three parameters are connected by the physical measurement process and thus the main QoS has to be described by a triple (Range / RCS / Pd). Of these three parameters, the RCS is the characterisation of a target object itself (i.e. size, shape and its body material's reflectivity of electromagnetic waves). The Pd for a certain RCS may be affected by interference, in turn having impact on detection range.

The second important operational parameter is the false alarm rate (FAR). The FAR indicates the probability that a target detection is declared when there is no target present. This happens due to the statistical behaviour of the noise signal being from time to time larger than the detection threshold. A typical radar system will adaptively set the detection threshold in such a way that the radar system is operated as a constant false alarm rate (CFAR) detector. For radar systems with a CFAR detector a noise-like interference may either cause a higher false alarm rate or lead to a reduced radar sensitivity and by that to a reduced detection range.

Concerning the protection criteria for the band 3.1-3.7 GHz ITU-R M.1465-1 [11] gives some guidance on parameters and protection criteria and recommends a protection objective of I/N -6 dB.

The required I/N protection criterion may vary dependent on the radar. Measurements of the detection probability Pd over interference level (I/N) can be used to derive the acceptable I/N value to ensure a certain detection probability (e.g. Report NTIA 06-444 [13] shows I/N values between -2 and -14 dB for a Pd of around 90%).

This report will use the protection criterion I/N of -6 dB, and in addition -10 dB as conservative assumption.

It should be further noted that the choice of I/N disregards the mitigating effects of improved self-resistance to interference implemented in modern radar system design by using advanced digital signal processing techniques (processing gain, phase sensitive detection, auto-correlated filtering, Moving Target Detection and tracking, Constant False Alarm Rate detection, etc.).

4.3 ESTIMATION OF THE NUMBER OF ACTIVE LDC UWB DEVICES PER RADAR

MAINBEAM

The below two tables provide calculation of the required protection distance to fulfil the I/N protection objective of the Radiolocation Service from a single LDC UWB device. Time domain effects are not considered thus the interfering device is assumed to operate in a continuous transmission mode.

Table 6: MCL calculations of impact range from a single UWB LDC device, free space loss

	generic outdoor	generic indoor	vehicle	generic outdoor	generic indoor	vehicle
Frequency / GHz	3.1	3.1	3.1	3.1	3.1	3.1
Bandwidth MHz	1	1	1	1	1	1
Transmit power dBm/BW e.i.r.p.	-41.3	-41.3	-53.3	-41.3	-41.3	-53.3
Wall attenuation	0	10	0	0	10	0
Antenna gain dBi	42	42	42	42	42	42
Noise figure F dB	2	2	2	2	2	2
Thermal noise kTBF dBm/BW	-112	-112	-112	-112	-112	-112
Protection criterion I/N dB	-6	-6	-6	-10	-10	-10
Max acceptable interference power dBm/MHz	-118	-118	-118	-122	-122	-122
MCL dB	118.7	108.7	106.7	122.7	112.7	110.7
Protection distance free space loss m	6586.25	2082.76	1654.39	10438.51	3300.95	2622.03

By looking at the results reported in the previous Table 6, the maximum protection range under line of sight conditions for I/N=-6 dB criteria is 6586m and for I/N=-10 dB it is 10438m.

The derivation of the number of active interfering LDC UWB devices for the following time domain studies will be done hereafter with the protection distance from the single entry calculations under free space loss conditions. The power aggregation of more than one LDC UWB device in the radar main beam and additional losses are not considered here.

Assuming a uniform spatial distribution of LDC UWB devices with a certain density inside the protection radius, one can calculate the number of LDC devices inside the protection area spanned by antenna beam and protection radius. For the case of radar devices with rotating antennas we have a total protection area using 360 degree and a single-beam protection area.

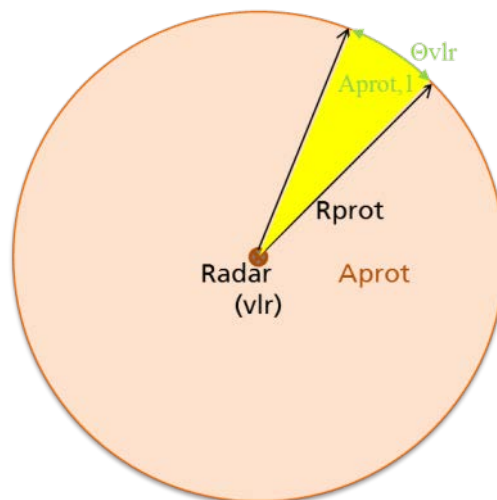
**Figure 2: scenario for the time domain calculations**

The below table summarises the estimations for the number of active devices. Detailed calculations are provided in ANNEX 2:.

Table 7: Range of active devices for AF between 1 % and 25 %

Density km ²	Activity Factor	Active devices per mainbeam, Average	Average number of active devices per 360°	Active devices per mainbeam, Average	Average number of active devices per 360°
		I/N -6 dB		I/N -10 dB	
1	1%	0.0002-0.0009	0.06-0.29	0.0005-0.002	0.2-0.7
10	1%	0.002-0.009	0.6-2.9	0.005-0.02	1.7-7.1
100	1%	0.02-0.09	6-29	0.05-0.22	17-71
100	10%	0.2-0.9	66-289	0.5-2.2	173-711
100	25%	0.5-2.2	166-722	1-5	433-1776

The above results were derived based on the assumption that the devices are uniformly distributed in space. This is a rough estimate and is not considering the real distribution of devices in space (e.g. indoor devices will be distributed only inside buildings and vehicle devices will be operated only on roads). The worst case number of active devices in a single mainbeam will depend on the eventual spread of LDC UWB devices and their pattern of usage and it might be speculatively extrapolated from above numbers that it could reach in certain azimuth directions 1 to 5 active devices per radar main beam. However, the uniform distribution results should be a reasonable estimate when averaging over all azimuth directions.

4.4 ANALYTICAL TIME DOMAIN CALCULATIONS

In this section the probability that the radar observation time is overlapping with LDC UWB packet bursts will be analytically assessed (see [14]) . Figure 3 defines the used parameters.

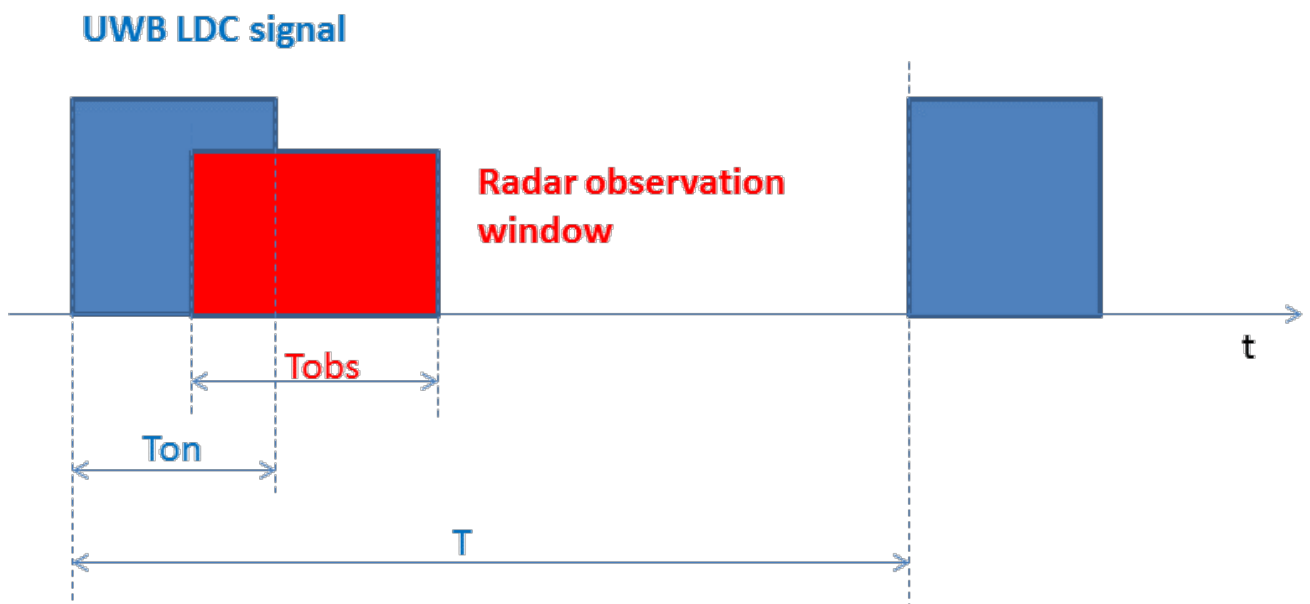

Figure 3: Time domain parameters

The probability of the coincidence of a single active UWB transmit time window T_{on} and a radar receive window T_{obs} can be calculated as

$$Prob_{overlap} = 1 - [(T - T_{obs}) - T_{on}] / T \quad (1)$$

with T as the repetition time of the LDC UWB signal.

For multiple active interferers, the probability of the coincidence of several UWB transmit time windows and a radar receive time window (T_{obs}) can be calculated using a discrete binomial distribution as a statistical model. Assuming the coincidence of UWB transmit window and radar receive window is equally distributed and can be described as

$$p = \frac{T_{obs} + T_{on} - \delta T / 2}{T} \quad (2)$$

The value δT can be used to define a minimum overlap duration that ensures for example a certain interference effect.

The probability of N UWB devices without any coincidence with the radar receive window is described by:

$$\overline{Prob}_{overlap} = P_n(N; p) = \binom{N}{n} p^n (1-p)^{N-n} \quad \overline{Prob}_{interfere} = P_n(N; p) = \binom{N}{n} p^n (1-p)^{N-n} \quad (3)$$

with $n=0$.

The parameter n is the number of allowed overlaps, which is 0 in this case.

As a result, the probability of an interference with N number of LDC UWB devices can be calculated as:

$$Prob_{overlap} = 1 - \overline{Prob}_{overlap} = 1 - P_0(N; p) = 1 - \binom{N}{0} p^0 (1-p)^{N-0} \quad (4)$$

$$Prob_{overlap} = 1 - \left(1 - \frac{T_{obs} + T_{on} - \delta T / 2}{T}\right)^N \quad (5)$$

It should be noted that formula (5) is just defined for $0 \leq \frac{T_{obs} + T_{on} - \delta T / 2}{T} \leq 1$.

The LDC UWB parameters T_{on} , T can be taken from section 2.3. Formula (5) gives the probability that T_{on} is overlapping at least by δT with T_{obs} . Here δT is the assumed minimum overlap time. For comparison with a simulation result in the following section, δT is the time increment of the simulation.

The above formula (5) is used below to calculate the overlap probability for possible UWB LDC UWB parameters and typical radar parameters. Further information to this investigation can be found in ANNEX 1:.

Parameters for the Victim:

- Rotation speed 30°/s;
- Beam width 1.1°;
- 10 elevation beams per azimuth window means 10% of azimuth window time at 0° elevation;
- $T_{obs} = 1.1^\circ / 30^\circ/s * 10\% = 3.67ms$.

Parameters of LDC UWB:

- $T_{on} \leq 5ms$;
- $DC = T_{on} / (T_{on} + T_{off}) = T_{on} / T \leq 0.5\%$;
- Mean $T_{off} \geq 38 ms$.

Possible values:

- Maximum Ton 5ms -> Toff 995ms, T 1000ms;
- Minimum Ton 0.2ms -> Toff 39.8ms, T 40ms.

Table 8: Overlap probability calculated with analytical formula

all ms							
Ton ms	5	1	0.5	0.2	0.2	0.2	2
DC	0.50%	0.50%	0.50%	0.50%	0.50%	0.50%	5.00%
Toff ms	995	199	99.5	39.8	39.8	39.8	38
T ms	1000	200	100	40	40	40	40
N (active devices mainbeam)	1	1	1	1	2	3	1
beam width°	1.1	1.1	1.1	1.1	1.1	1.1	1.1
rotation speed °/s	30	30	30	30	30	30	30
percentage 0° elevation	10%	10%	10%	10%	10%	10%	10%
Tobs ms	3.67	3.67	3.67	3.67	3.67	3.67	3.67
delta t ms	2.00E-02	2.00E-02	2.00E-02	2.00E-02	2.00E-02	2.00E-02	2.00E-02
overlap probability P	0.86%	2.32%	4.15%	9.62%	18.31%	26.16%	14.12%

Note: the above calculation includes the temporary possible DC of 5% per second, which could be used by 10% of all deployed devices

The results from Table 8 are based on current allowed LDC limits and indicate that the overlap probability for a single LDC UWB device in the radar mainbeam ranges from 0.86 % to 9.62 %. If there are 3 LDC UWB devices in the main beam the overlap probability becomes 26%.

The below Figure 4 is summarising the results of the analytical calculations for large range of currently allowed LDC parameters.

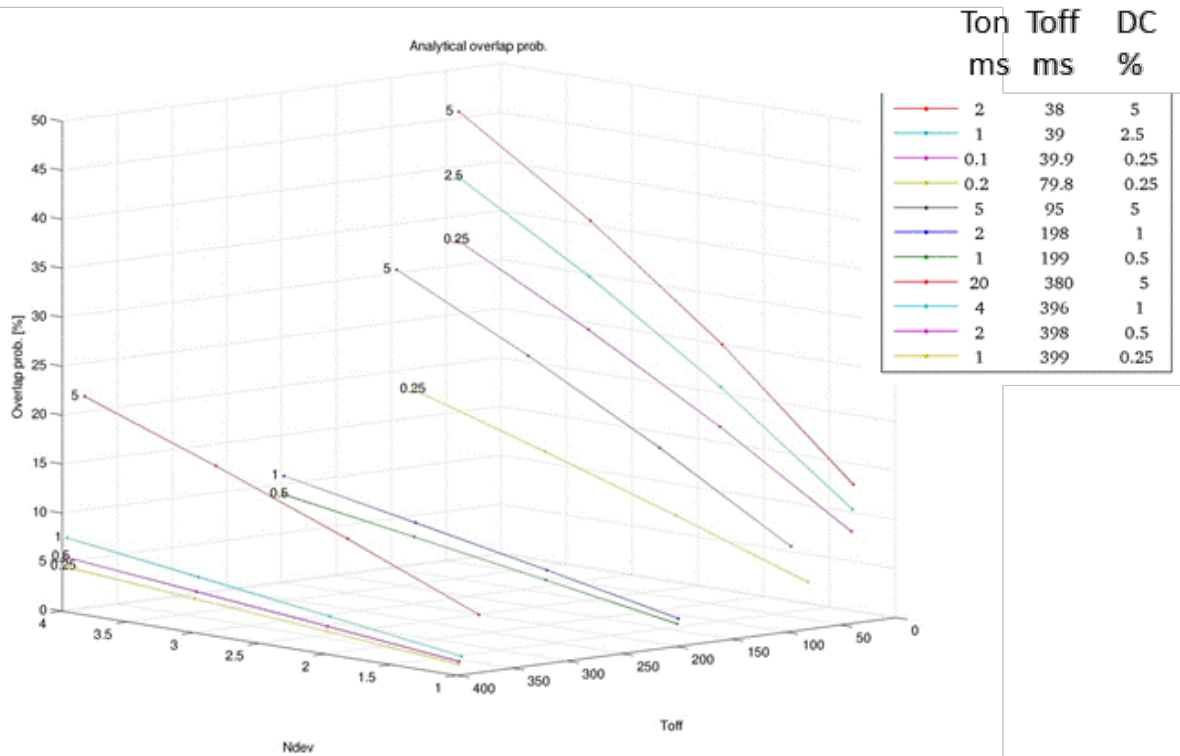

Figure 4: Analytical overlap probability results for 13 different LDC parameter sets

4.5 TIME DOMAIN SIMULATIONS WITH MATLAB

The same scenario which has been analytically assessed in the previous section will be simulated in this section. Based on the LDC UWB parameters and the radar beam receive time (Tobs) the overlapping time will be computed for a fixed number of radar antenna turns using only time-domain parameters.

One can place one or more LDC devices into a single azimuth sector to investigate the overlap situation in a single sector and for different number of LDC devices. It represents a “parked antenna” situation and is analysed in 4.5.1.

The “rotating antenna” situation is assessed in 4.5.2. One or more LDC devices will be simulated in different azimuth sectors by choosing a uniform number generator with values between 0 and 12 seconds (30° per second rotation speed). This number can be converted to the corresponding azimuth sector.

For each LDC device the LDC waveform is generated with statistically varied start time for each antenna turn.

For single events the algorithms presents individual overlap probability which varies from run to run. The variation of the simulation result is smaller if more turns are used because the simulation is then averaged over a larger number (Results for 1200 turns will be shown).

Figure 5 is given an overview of the simulations. More details are provided in ANNEX 1:.

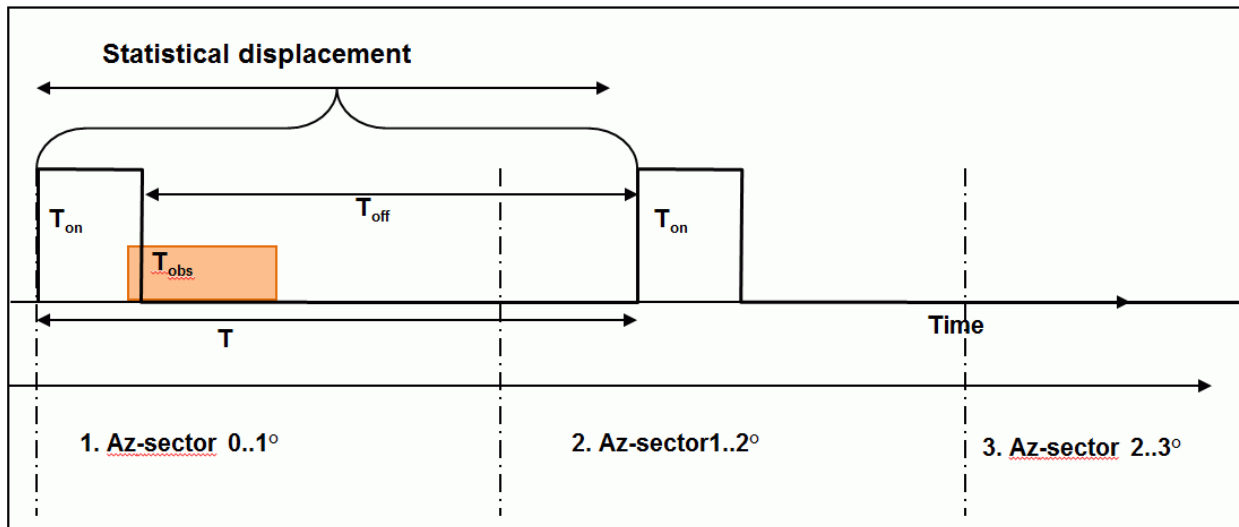

Figure 5: Time vector view to simulate the channel access collision probability

To derive the probability of an overlap of T_{on} and T_{obs} by an amount of at least $\delta T/2$ (the below figures indicating this with dt), the program simulates a finite number of turns and counts the overlap incidences either per turn or per azimuth-sector, leading to a certain percent value treated as overlap probability per turn or per azimuth-sector (both are computed).

The minimum assumed overlap time is defined by the time sampling of the time vector.

4.5.1 Time Domain simulation results for a single azimuth sector

The program can place one or more LDC pattern into a single azimuth sector as to simulate a “parked antenna mode”. In this mode the overlap probabilities for an integer number of devices inside the single azimuth sector can be analysed. Figure 6 shows the results for one set of parameter.

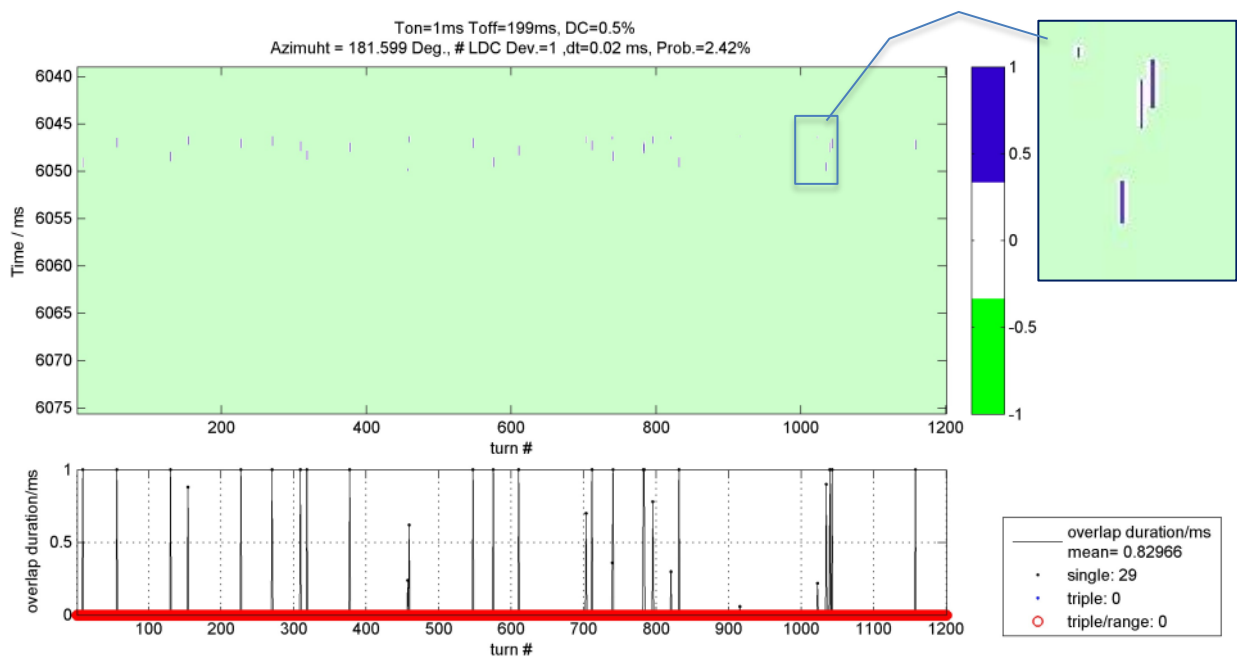

Figure 6: Example simulation result for a single LDC device at a fixed radar azimuth angle. Shown is radar azimuth in time coordinates (12sec==360deg) over simulated turn number

In the figure above the upper image colour-codes the number of simultaneously occurring overlaps. A value of -1 in colour green meaning there isn't an overlap in the actual time cell and there are no overlaps in the turns before and after the actual cell. A value of 0 (colour code white) means there is no overlap in the actual time cell but there is one in the turn before or after (only visible in the zoomed window). Blue colour shows the number of simultaneous overlaps. In the example above only one LDC device is considered.

In the lower plot of the above Figure 6 the overlap duration is shown as black curve and black dots. Blue dots named "triple" indicates that overlap incidents happened in three consecutive turns (in this case 0). The red circles in the lower plot indicate the fact that those consecutive overlap incidents (in this case 0) as mentioned before appear at the same time instance ("triple/range" with range meaning δT).

The simulation shows 29 detected overlaps over 1200 turns ($29/1200=0.0242$). The overlap probability from Figure 6 of 2.42% for a single azimuth sector fits with the analytical calculation (2.32%). The mean overlap duration is 0.83ms. No overlap is happening for three consecutive radar turns, which means that no observed radar track would be lost.

The same simulation can be carried out with a worst case LDC parameter set of $T_{on}=0.2\text{ms}$ and $T_{off}=39.8\text{ms}$. As can be seen, the total amount of turns with overlaps increases to 117 out of 1200 (9.75%) but also the mean duration of these overlaps decreases to 0.18ms. Also here the result of the analytical calculation is confirmed.

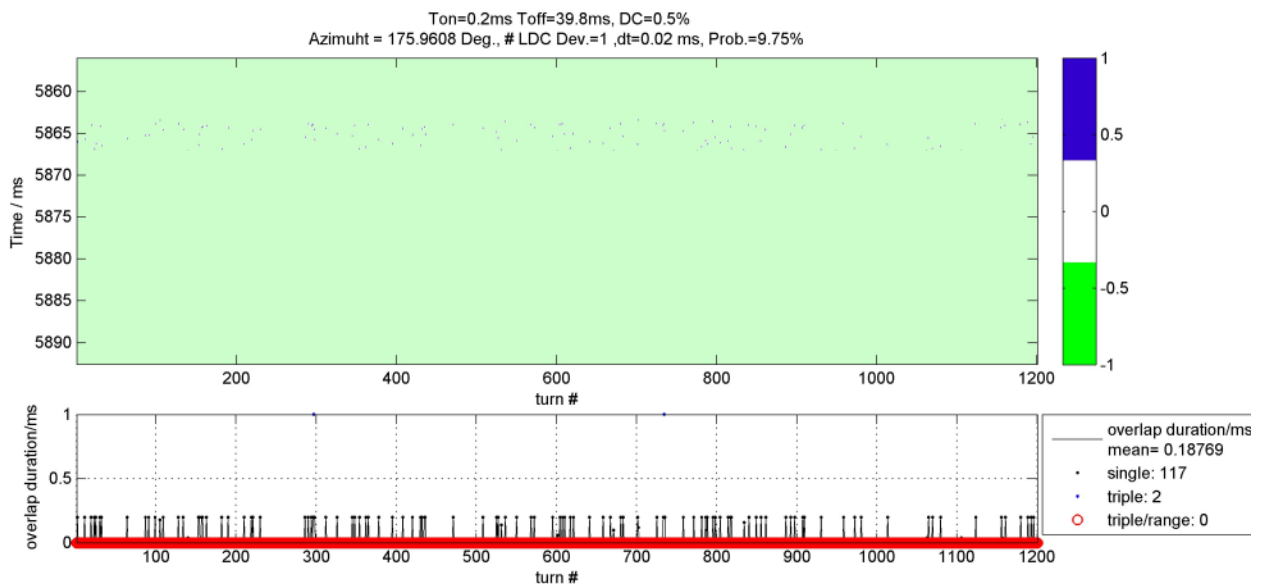

Figure 7: Example simulation result for a single LDC device with worst case LDC parameter set at a fixed radar azimuth angle. Shown is radar azimuth in time coordinates (12sec==360deg) over simulated turn number

The results for 4 LDC UWB devices are shown below in addition to the above results for a single LDC UWB device per mainbeam.

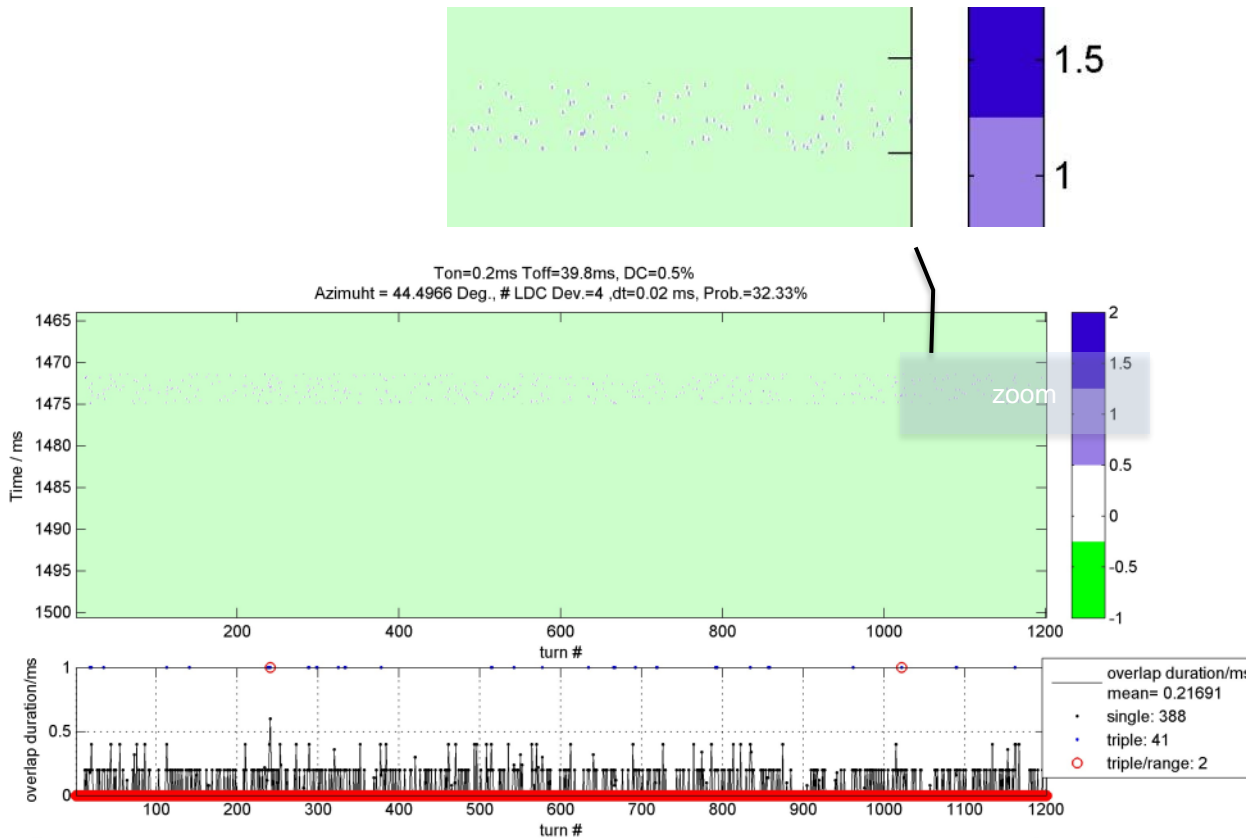

Figure 8: Example simulation result for four LDC devices with worst case LDC parameter set at a fixed radar azimuth angle. Shown is radar azimuth in time coordinates (12sec==360deg) over simulated turn number

The simulation result of 32.33% is again confirming the analytical result of 33.3%, the simulation slightly underestimates this in the presented result. For these scenario two occurrences of three overlaps in a row in the same radar range is reported. Also the simultaneous overlaps of two devices at the same time is reported (blue scale goes up to 2).

4.5.2 Time Domain simulation results for all azimuth sectors

In this mode the program places a fixed number of N LDC UWB devices over the 12 seconds time vector based on uniform distribution. It can be seen as simulating a rotating antenna. In a resulting plot from several simulated radar turns all azimuth sectors have to be shown.

Results are shown for a single LDC device, 13 LDC devices and 100 LDC devices.

For the case of simulating a rotating radar antenna two different output figures are used to show the results. The first output figure (e.g. Figure 9) shows the used simulation parameters, the analytic overlap probability and the averaged simulated overlap probability based on the azimuth sectors with LDC devices. The graph shows the overlap probability for each azimuth sector. The second output figure includes an image that color-codes the overlap duration in an azimuth over turn number plot (e.g. Figure 10). Two additional graphs display the overlap duration and other parameters, one graph shows the results for each azimuth sector averaging over the simulated number of turns the other graph shows the results for each turn by accumulating over all azimuth sectors.

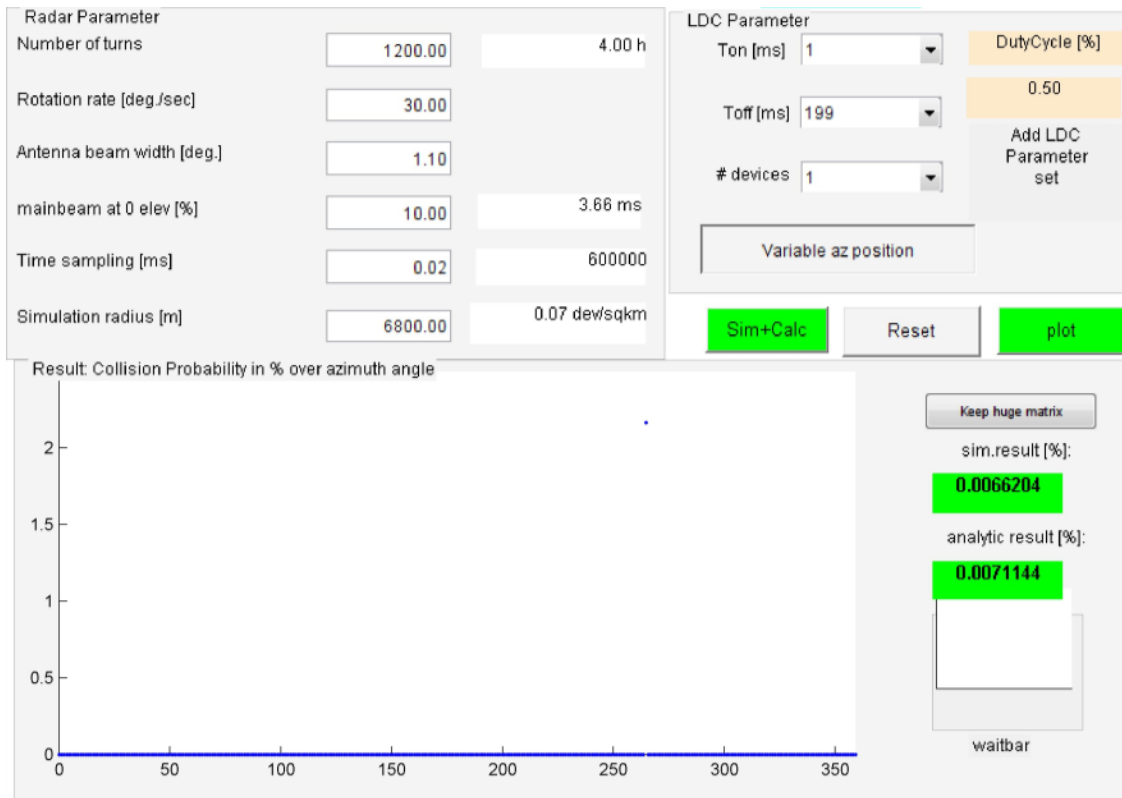

Figure 9: Example simulation GUI (graphical user interface) for a single LDC device with rotating antenna

In Figure 9 the first output figure is shown. It includes the simulation parameters and a collision probability plot over radar azimuth. The simulation result averaged over all azimuth sectors is shown to the lower right corner and can be compared with the analytic results. The difference of simulation results and analytic result is due to the limited number of experiments in the simulation.

The following Figure 10 shows the second output figure with the overlap duration color-coded in an azimuth over turn number image. The small pixels are not apparent until the image is zoomed (shown in Figure 11).

Figure 10 is divided into 3 subplots. On the left hand the accumulated overlap duration per azimuth sector and the overlap probability per azimuth sector is plotted (This plot is similar to the plot in the first output figure, but now also includes the accumulated overlap duration). The bottom plot shows the overlap duration per turn summed up over all azimuth sectors. Additionally the mean overlap duration and overlap probability evaluated for each radar azimuth is shown in Figure 9 above in the left plot and its legend. Corresponding evaluation for each antenna turn is shown in lower plot and the corresponding right hand legend.

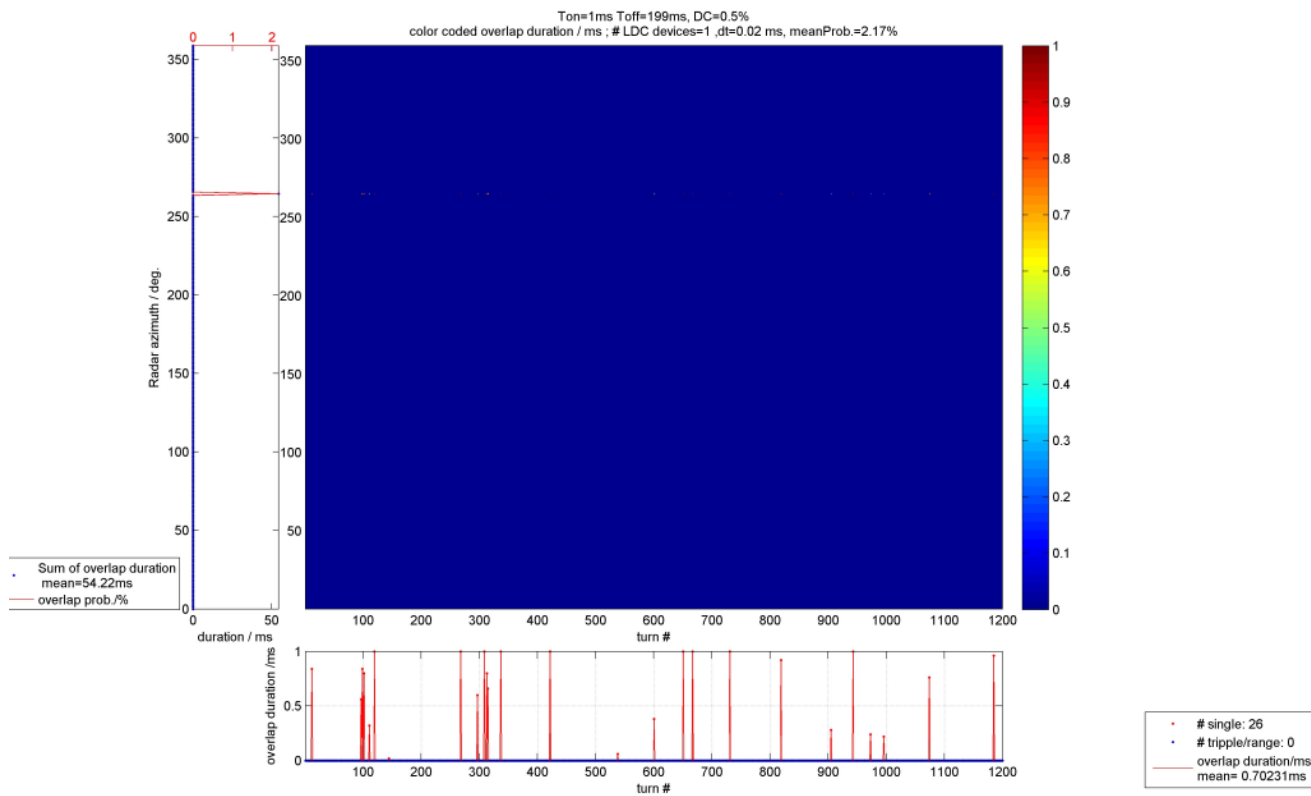

Figure 10: Example simulation result for a single LDC device with rotating antenna. Radar azimuth over turn number with overlap time color-coded

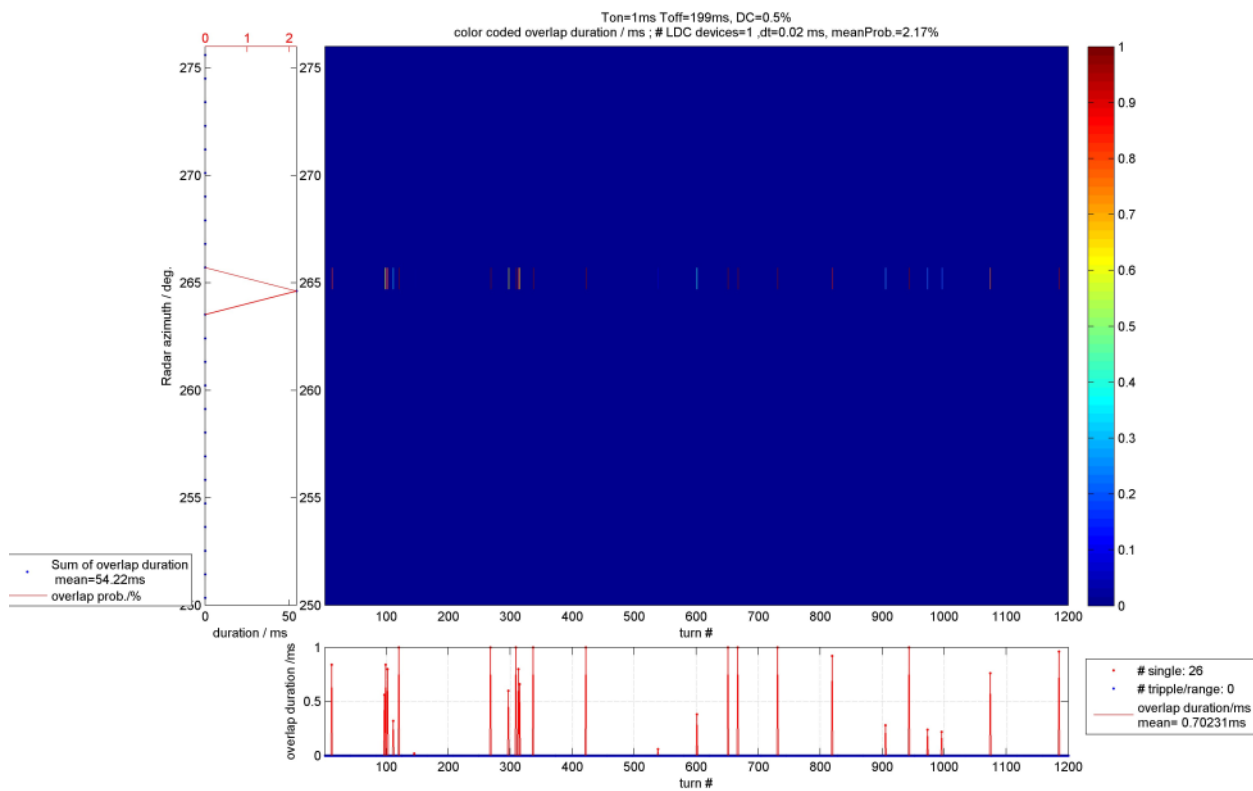

Figure 11: Example simulation result for a single LDC device and rotating radar antenna. Radar azimuth over turn number with overlap time shown color-coded, zoomed view of Figure 10

The simulated mean duration of the overlaps is 0.7ms for a single LDC UWB device with a Ton time of 1ms. The simulated overlap probability is 2.17 % for that example which is in the order of the analytical calculations from the previous section (2.34%).

Results for multiple active LDC UWB devices (N=13) and rotating radar antenna is provided in the following figures.

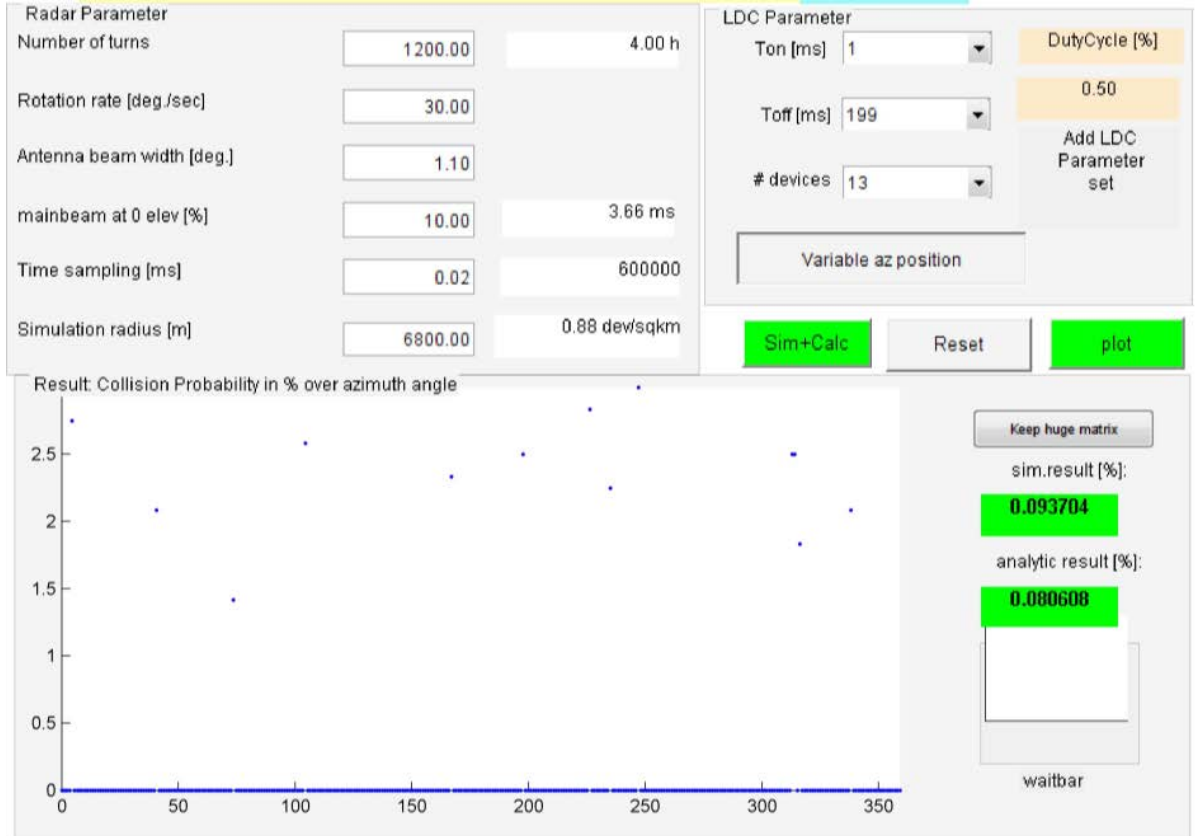

Figure 12: Example simulation GUI (graphical user interface) for multiple LDC devices with rotating antenna

In Figure 12 above parameters are shown and the collision probability over radar azimuth. The simulation result averaged over all azimuth sectors is shown to the lower right corner and can be compared with the analytic results.

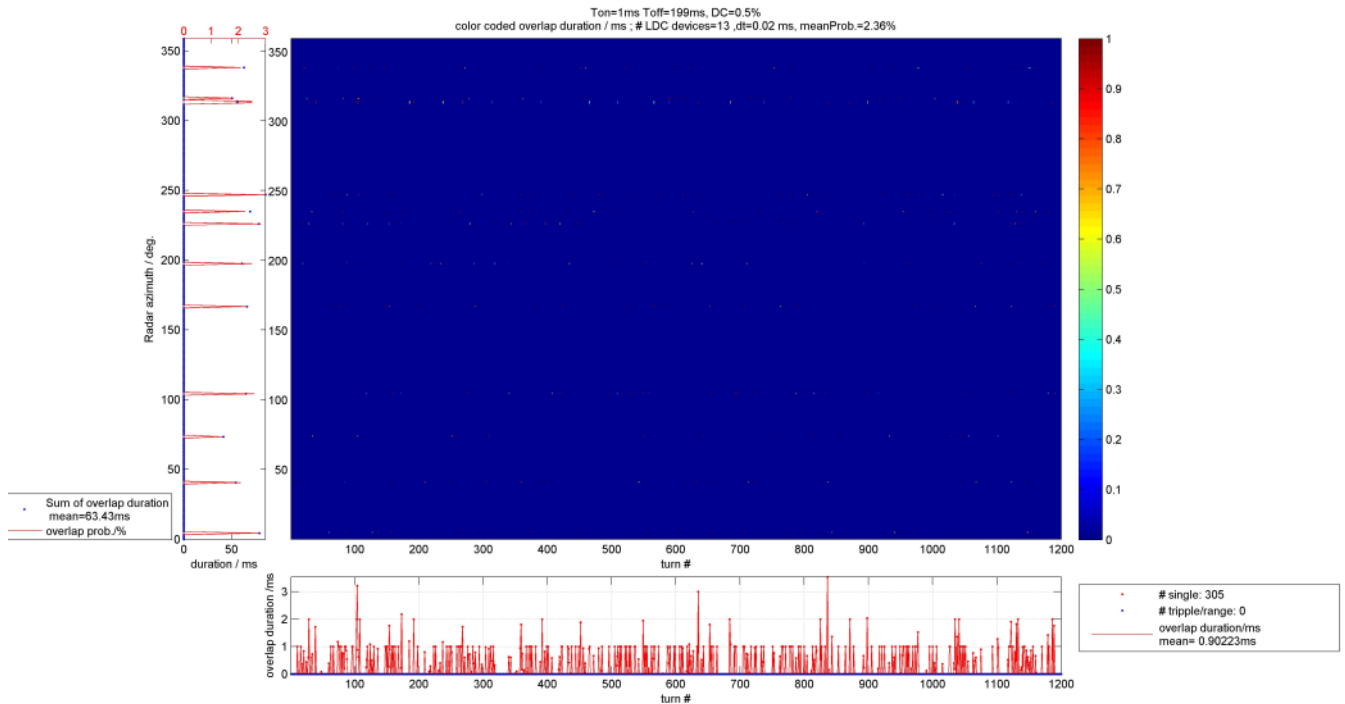

Figure 13: Example simulation result for multiple active LDC devices (N=13) and rotating radar antenna. Radar azimuth over turn number with overlap time color-coded

Note that the mean overlap probability as shown in Figure 13 (2.36%) is calculated using overlap probability per azimuth sector and only taking into account azimuth sectors with an overlap occurring (disregarding the zero entries).

The simulation in Figure 13 shows 305 detected overlaps over 1200 turns ($305/1200=0.254$). That means that 25.4 % of the radar turns include at least one channel collision in any azimuth direction.

The above results for 13 active devices spread over 360° can't be compared with the analytical calculation, where 13 active devices are assumed in each mainbeam.

The mean overlap duration during one radar antenna turn is 0.9ms. No overlap is happening for three consecutive radar turns.

The example with 13 LDC devices shows compared to a single LDC device that the overlap probability for each single radar azimuth window varies from 2% to 3%, but more azimuth turns will have an overlap event (now 305 instead of 26).

A simulation with 100 devices (within 360°) using the worst case LDC parameter set is shown below.

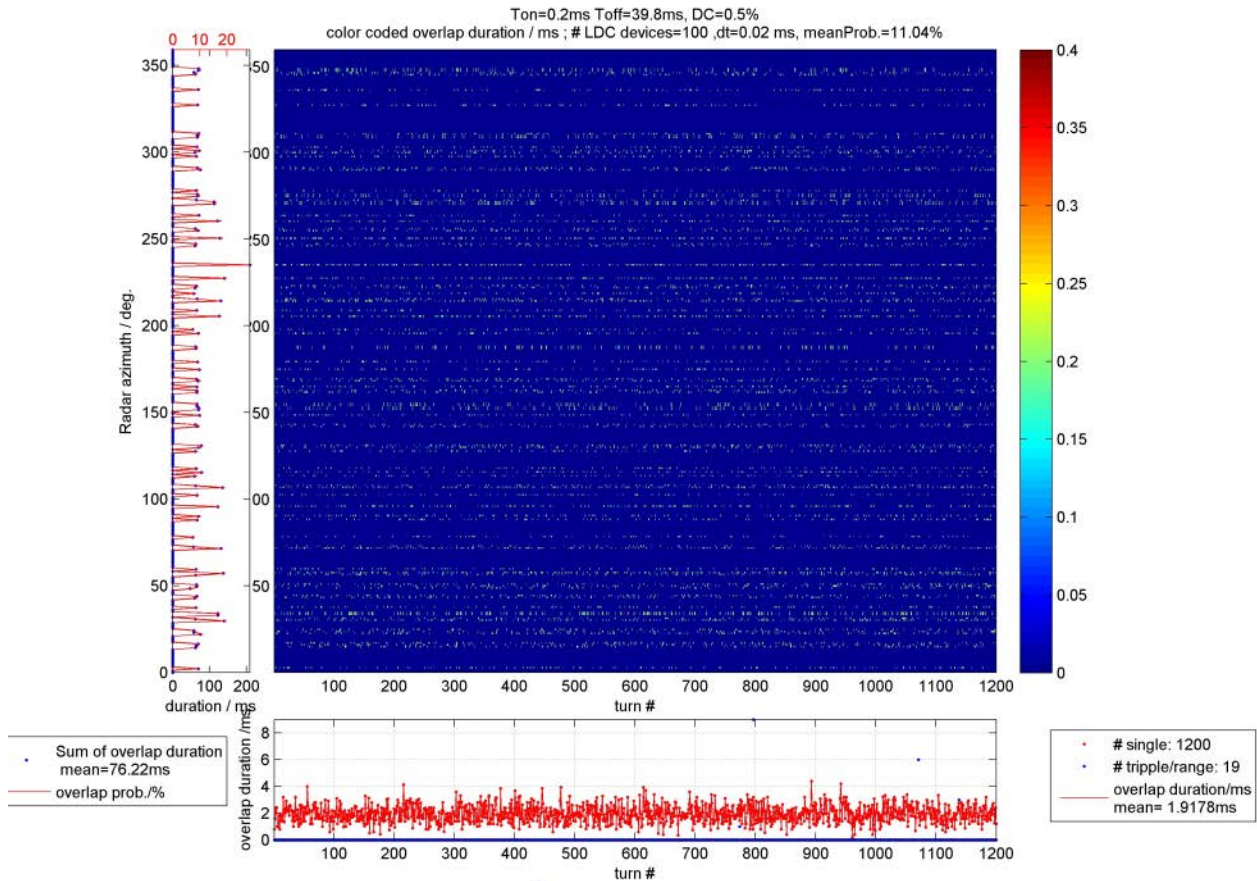

Figure 14: Example simulation result for multiple active LDC devices (N=100) and rotating radar antenna. Radar azimuth over turn number with overlap time color-coded

This result shows that there will be overlaps in every radar antenna turn. In each turn the accumulated overlap time is 1.9ms.

4.6 SUMMARY RADIOLOCATION

The below two tables are summarising the results.

Table 9: Range of results based on I/N=-6dB

Density /km ²	Activity Factor	Average number of active devices per 360°	Number of interfered beams per rotation	
			Best case LDC timing (1% mainbeam overlap probability) . Note	Worst case LDC timing (10% mainbeam overlap probability). Note
1	1%	0.06-0.29	0.0006-0.0029 (one beam every 345 th to 1670 th rotation)	0.006-0.029 (one beam every 35 th to 167 th rotation)
10	1%	0.6-2.9	0.006-0.029 (one beam every 35 th to 167 th rotation)	0.06-0.29 (one beam every 3rd to 16 th rotation)
100	1%	6-29	0.06-0.29	0.6-2.9
100	10%	66-289	0.7-2.9	6.6-28.9

			Number of interfered beams per rotation	
100	25%	166-722	1.7-7.2	16.6-72.2

Note: the exact probability values of 0.86% and 9.62% were rounded to 1% and 10%

Table 10: Range of results based on I/N=-10dB

			Number of interfered beams per rotation	
Density /km ²	Activity Factor	Average number of active devices per 360°	Best case LDC timing (1% mainbeam overlap probability). Note	Worst case LDC timing (10% mainbeam overlap probability). Note
1	1%	0.2-0.7	0.0017-0.007 (one beam every 143 th to 588 th rotation)	0.017-0.07 (one beam every 14 th to 59 th rotation)
10	1%	1.7-7.1	0.017-0.07 (one beam every 14 th to 59 th rotation)	0.17-0.7
100	1%	17-71	0.17-0.7	1.7-7
100	10%	173-711	1.7-7.1	17-71
100	25%	433-1776	4.3-17.8	43-178

Note: the exact probability values of 0.86% and 9.62% were rounded to 1% and 10%

For the assumed rural deployment density of 100 LDC UWB devices per km² with activity factors of 1 to 10% and under the actual LDC parameter regulation (1% to 10% main beam overlap probability) the number of interfered beams per rotation statistically varies between 0.06 and 28.9 for an I/N of -6 dB (0.17 to 71 for I/N of -10 dB).

Practically that means for an I/N of -6 dB on the lower end that every 17th rotation (roughly every 3 minutes) one overlap will occur and on the upper end 29 beams per rotation (one overlap each 0.4 seconds) will see an overlap.

The above results are based on the assumptions that all LDC UWB devices are in LOS to the radar. The report assumes that the overlap probability can be treated as an interference probability, e.g. that any overlap in time with the radar main beam is causing an interference.

5 CONCLUSIONS

This ECC Report analysed the impact of LDC UWB on the radiolocation service in the band 3.1 to 3.4 GHz. The protection criterion I/N of -6 dB and -10 dB are used, with the latter as more conservative assumption than in the ITU-R M.1465-1 [10] which recommends a protection objective of I/N -6dB.

For the assumed rural deployment density of 100 LDC UWB devices per km² with activity factors of 1 to 10% and under the actual LDC parameter regulation (1% to 10% main beam overlap probability) the number of interfered beams per rotation statistically varies between 0.06 and 28.9 for an I/N of -6 dB (0.17 to 71 for I/N of -10 dB).

Practically that means for an I/N of -6 dB on the lower end that every 17th rotation (roughly every 3 minutes) one overlap will occur and on the upper end 29 beams per rotation (one overlap each 0.4 seconds) will see an overlap.

The above results are based on the assumptions that all LDC UWB devices are in LOS to the radar. The report assumes that the overlap probability can be treated as an interference probability, e.g. that any overlap in time with the radar main beam is causing an interference.

It should be noted that the choice of I/N disregards the mitigating effects of improved self-resistance against interference implemented in modern radar system design by using advanced digital signal processing techniques (processing gain, phase sensitive detection, auto-correlated filtering, Moving Target Detection and tracking, Constant False Alarm Rate detection, etc.).

For radar systems with a CFAR detector a noise-like interference may either cause a higher false alarm rate or lead to a reduced radar sensitivity resulting in a reduced detection range. That means that low RCS targets at maximum instrumented range will no longer be detected.

It was not possible to determine in a general way whether the interference will be seen as harmful as this depends on the processing capabilities of an individual radar.

ANNEX 1: DESCRIPTION OF TIME-DOMAIN SIMULATION

In order to compute the probability of Channel Access Collision between a single UWB LDC device and a radio location radar the following strategy can be developed:

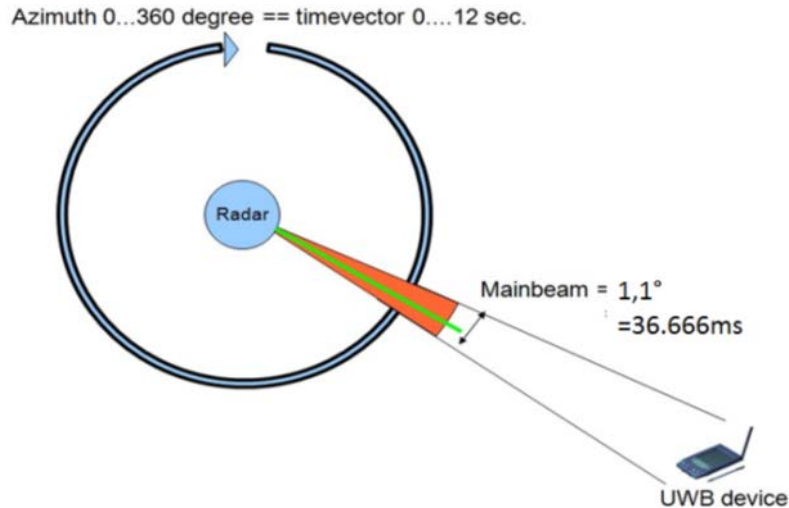

Figure 15: Time domain simulation strategy for single UWB LDC interferer

Let us assume that the LDC UWB device stays fixed in a certain radar antenna azimuth sector. The rotation rate of the radar antenna gives the time the UWB device stays within the radar main beam as shown in Figure 15. If we have a 3D radar the main beam is swept in elevation during the 36 ms azimuth main beam time and only during the zero degree elevation an interference can occur.

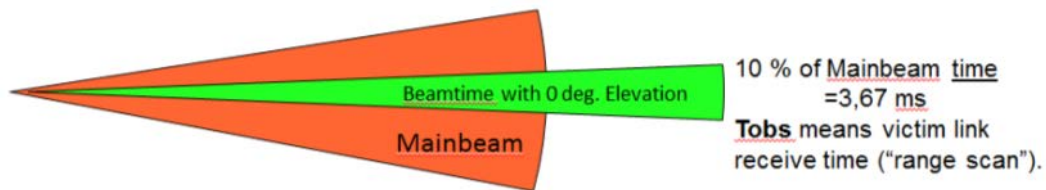

Figure 16: Simulation strategy for 3D radar.

For long range surveillance radar systems the pulse length is much smaller than the receive time window and we can assume the full 3.6 ms as the receive time during which an interference can occur. Now the interference scenario on the time vector is shown in Figure 17. This scenario can be implemented by using two binary vectors, one representing a single T_{obs} instance by logical ones and one vector by representing the T_{on} times by logical ones. Simply multiplying the two vectors and looking for a resulting one indicates the interference occurrence. Counting the ones gives the duration of the interference in terms of time increment. A typical time increment (time sampling) has to be in the order of 1/10 of the T_{on} value or smaller. For 12 seconds the element count of the time vectors can become large.

The statistical displacement of the beginning of the LDC waveform is necessary to remove a stroboscope effect that happens if the start of the first azimuth sector and the start of the first T_{on} stays constant. This is also useful if more than one LDC UWB device have to be simulated.

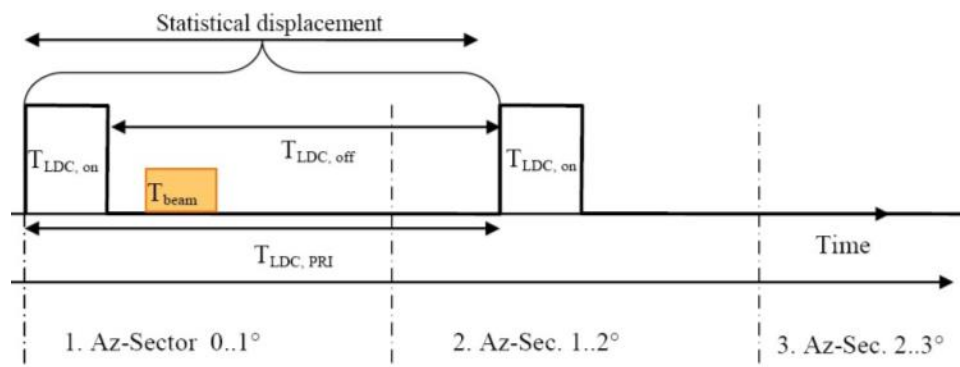

Figure 17: Time vector display to simulate the interference probability

ANNEX 2: ACTIVE DEVICES PER MAINBEAM

The below tables are showing the active devices per mainbeam with the following assumptions:

- The simulation radius derived from the single entry MCL calculations;
- the LDC UWB assumptions given in section 2.3;
- a 3 dB radar antenna beamwidth of 1.1° ;
a variable activity factor AF (percentage the device is active over a day) between 1% and 50 %;
- the Duty Cycle DC of the LDC UWB devices are not considered here because those effects will be considered in the following time domain studies;
- the UWB device density of 100/km² is assumed as a worst case in the rural environment.

**Table 11: active devices per mainbeam for the probabilistic studies
with AF 1% and 10%, IN -6 dB**

	generic outdoor	generic indoor	vehicle		generic outdoor	generic indoor	vehicle	
simulation radius km	6.5	2.1	1.7		6.5	2.1	1.7	
device density /km ²	100	100	100		100	100	100	
percentage in/outdoor	5%	95%	100%		5%	95%	100%	
device density /km ²	5	95	100		5	95	100	
AF %	1%	1%	1%		10%	10%	10%	
beamwidth °	1.1	1.1	1.1		1.1	1.1	1.1	
active devices within simulation radius	6.6366	13.1617	9.0792	29	66.3661	131.6170	90.7920	289
active devices mainbeam	0.0203	0.0402	0.0277	0.09	0.2028	0.4022	0.2774	0.9
device density for 1 active per mainbeam	247	2362	3605		25	236	360	

Note: Table above embedded as Excel document.

**Table 12: active devices per mainbeam for the probabilistic studies
with AF 25% and 50%, IN -6 dB**

	generic outdoor	generic indoor	vehicle		generic outdoor	generic indoor	vehicle	
	density 100, AF 25%				density 100, AF 50%			
simulation radius km	6.5	2.1	1.7		6.5	2.1	1.7	
device density /km ²	100	100	100		100	100	100	
percentage in/outdoor	5%	95%	100%		5%	95%	100%	
device density /km ²	5	95	100		5	95	100	
AF %	25%	25%	25%		50%	50%	50%	
beamwidth °	1.1	1.1	1.1		1.1	1.1	1.1	
active devices within simulation radius	165.9154	329.0426	226.9801	722	331.8307	658.0851	453.9601	1444
active devices mainbeam	0.5070	1.0054	0.6936	2.21	1.0139	2.0108	1.3871	4.4
device density for 1 active per mainbeam	10	94	144		5	47	72	

Note: Table above embedded as Excel document.

**Table 13: active devices per mainbeam for the probabilistic studies
with AF 1% and 10%, IN -10 dB**

	generic outdoor	generic indoor	vehicle		generic outdoor	generic indoor	vehicle	
	density 100, AF 1%				density 100, AF 10%			
simulation radius km	10.5	3.3	2.6		10.5	3.3	2.6	
device density /km ²	100	100	100		100	100	100	

	generic outdoor	generic indoor	vehicle		generic outdoor	generic indoor	vehicle	
percentage in/outdoor	5%	95%	100%		5%	95%	100%	
device density /km ²	5	95	100		5	95	100	
AF %	1%	1%	1%		10%	10%	10%	
beamwidth °	1.1	1.1	1.1		1.1	1.1	1.1	
active devices within simulation radius	17.3180	32.5013	21.2372	71	173.1803	325.0135	212.3717	711
active devices mainbeam	0.0529	0.0993	0.0649	0.22	0.5292	0.9931	0.6489	2.2
device density for 1 active per mainbeam	94	957	1541		9	96	154	

Note: Table above embedded as Excel document.

Table 14: active devices per mainbeam for the probabilistic studies with AF 25% and 50%, IN -10 dB

	generic outdoor	generic indoor	vehicle		generic outdoor	generic indoor	vehicle	
	density 100, AF 25%				density 100, AF 50%			
beamwidth °	1.1	1.1	1.1		1.1	1.1	1.1	
active devices within simulation radius	17.3180	32.5013	21.2372	71	173.1803	325.0135	212.3717	711
active devices mainbeam	0.0529	0.0993	0.0649	0.22	0.5292	0.9931	0.6489	2.2

Note: Table above embedded as Excel document.

ANNEX 3: LIST OF REFERENCES

- [1] ECC Decision (06)04, The harmonised conditions for devices using Ultra-Wideband (UWB) technology in bands below 10.6 GHz approved 24 March 2006, amended 6 July 2007, amended 9 December 2011
- [2] ETSI TS 103 060 V1.1.1 (2013-09), Method for a harmonized definition of Duty Cycle Template (DCT) transmission as a passive mitigation technique used by short range devices and related conformance
- [3] ETSI TR 103181-2, Short Range Devices (SRD) using Ultra Wide Band (UWB);Transmission characteristics Part 2: UWB mitigation techniques
- [4] ECC Report 64, Generic UWB applications below 10.6 GHz
- [5] ECC Report 170, Specific UWB applications in the bands 3.4 - 4.8 GHz and 6 - 8.5 GHz, location tracking applications for emergency services (LAES), location tracking applications Type 2 (LT2) and location tracking and sensor applications for automotive and transportation environments (LTA), Tallinn, October, 2011
- [6] ECC Report 94, Technical requirements for UWB LDC devices to ensure the protection of FWA systems, Nicosia, December 2006
- [7] ECC Recommendation (11)09, UWB Location Tracking Systems TYPE 2 (LT2), Approved 21 October 2011
- [8] CEPT Report 45, Report from CEPT to the European Commission in response to the Fifth Mandate to CEPT on ultra-wideband technology to clarify the technical parameters in view of a potential update of Commission Decision 2007/131/EC, Report approved on 21 June 2013 by the ECC
- [9] ITU-R Recommendation M.1464-1 (2003-06), Characteristics of radiolocation radars, and characteristics and protection criteria for sharing studies for aeronautical radionavigation and meteorological radars in the radiodetermination service operating in the frequency band 2 700-2 900 MHz
- [10] ITU-R Recommendation M.1465-1 (2007-03), Characteristics of and protection criteria for radars operating in the radiodetermination service in the frequency band 3 100-3 700 MHz
- [11] "Channel Access Rules for SRDs", study by IMST GmbH (November 2012), see: http://www.bundesnetzagentur.de/SharedDocs/Downloads/DE/Sachgebiete/Telekommunikation/Unternehmen_Institutionen/Koexistenzstudie_EN.pdf?__blob=publicationFile&v=2
- [12] ECC Recommendation (11)10, Location tracking application for emergency and disaster situations, Approved 21 October 2011
- [13] NTIA Technical Report TR-06-444, Effects of RF Interference on Radar Receivers, February 2006
- [14] Evaluation of LDC as mitigation technique for the radar service, Udo Uschkerat, Theresa Haumtratz, Frequenz No. 63, Page 214-216 (10/2009)
- [15] Contribution to ECC TG3 (2007-05) "Compatibility study between UWB LDC and radars in the frequency band 3.1-3.4 GHz" http://www.cept.org/Documents/se-24/21902/M80_Info2_SE24_TG319_08R0_Compat-ibility-study-between-UWB-LDC-and-radiolocalisation_-France
- [16] Contribution to ECC TG3 (2007-12) "Measurement campaign assessing the impact of LDC on S-band radar (3.1-3.4 GHz)", http://www.cept.org/Documents/se-24/21903/M80_Info3_SE24_TG321_13R0_LDC-Ra-dar_-France
- [17] Contribution to ECC TG3 (2008-05), "Results of compatibility measurements in the frequency band 3.1-3.4 GHz" http://www.cept.org/Documents/se-24/21904/M80_Info4_SE24_TG323_08R0_S-Band-Radar-coexistence-results_Germany