



ECC Report **362**

Compatibility between mobile or fixed communications networks (MFCN) operating in 3400-3800 MHz and wireless broadband systems in low/medium power (WBB LMP) operating in the frequency band 3800-4200 MHz with Radio Altimeters (RA) operating in 4200-4400 MHz

approved 8 November 2024

0 EXECUTIVE SUMMARY

0.1 HIGH-LEVEL SUMMARY

This ECC Report studies the compatibility of Radio Altimeters operating in the 4200-4400 MHz band with public 5G mobile networks operating in the 3400-3800 MHz band, referred to as mobile or fixed communications networks (MFCN), as well as with local and private 5G networks using low and medium power base stations in the 3800-4200 MHz band, referred to as wireless broadband systems low/medium power (WBB LMP).

The Radio Altimeter parameters used in this ECC Report are based on measurements for several Radio Altimeter models, with Interference Tolerance Thresholds (ITT) derived from published AVSI Reports¹ for heights of 200 feet and 1000 feet. The interference tolerance threshold values of the various Radio Altimeter models differ by several magnitudes. It is relevant to note that only usage category 1 (UC1) Radio Altimeters have been considered as that category is “used in a wider variety of safety-critical systems that enable safe operation of commercial airliners in all-weather conditions” (as stated in AVSI Report Vol. I).

The 5G technical parameters are derived from existing ECC Reports, ECC Decisions, ETSI standards and ITU-R documentation. The studies consider two different base station antenna types: Active Antenna Systems (AAS), which include electronic beamforming features, and more conventional non-AAS antennas with wider static beams covering the cell. The baseline assumptions for the base stations are found in Annex 1 of the ECC Report and include an assumption that AAS base station transmissions will be pointing at or below horizon (‘beamforming’) as typical or normal operation.

Different studies used different Radio Altimeter parameters described as Parameter Sets 1 and 2 within this ECC Report, that were based on information provided to CEPT:

- Parameter Set 1 contains data on a variety of Radio Altimeter models primarily derived from AVSI Report Volume III;
- Parameter Set 2 contains data based on AVSI Report Volume I and Volume II, for the least resilient Radio Altimeter model.

Both Parameter Sets also use different assumptions for the Radio Altimeter antenna. Section 5 of this ECC Report provides further details on these and other factors.

The main scenario was modelled as a nominal Instrument Landing System (ILS) approach with associated Obstacle Limitation Surface (OLS), as defined by the International Civil Aviation Organization (ICAO). These are described in section 5.

Two phenomena have been studied in this Report:

- The effect of unwanted emissions from WBB-LMP or MFCN in the adjacent bands falling in the 4200–4400 MHz band used by Radio Altimeters;
- The effect of blocking. Blocking is where a Radio Altimeter’s receiver performance is reduced by strong radiofrequency (RF) emissions from MFCN or WBB-LMP in the adjacent frequency bands.

A 6 dB safety margin, as recommended by ICAO, is taken into account in the conclusion of all studies.

Based on the above Radio Altimeter parameters, as well as typical base station parameters and set up, this ECC Report derives the following conclusions for the modelled ILS approach scenario:

For MFCN (5G) operating in frequency band 3400-3800 MHz

In summary, the results show:

- All studies of unwanted emissions, falling into the Radio Altimeter band from 5G MFCN operating in the 3400-3800 MHz frequency band, show sufficient margins covering at least the 6 dB ICAO safety margin;
- Studies of potential blocking of the Radio Altimeter receiver using Parameter Set 1 and associated antenna radiation patterns (including a roll angle of up to ± 15 degrees) and with MFCN 5G AAS base station main

¹ Aerospace Vehicle Systems Institute (AVSI) is an aerospace industry research cooperative that facilitates collaborative research and technology projects for its members. The referenced reports can be found at <https://avsi.aero>

beam pointing at or below the horizon show sufficient margins covering at least the 6 dB ICAO safety margin;

- Some studies of blocking using Parameter Set 2 have also extended parameters of the Radio Altimeter to heights other than 200 feet and 1000 feet. The outcome of these studies leads to some base station locations where the interference tolerance threshold at the Radio Altimeter is exceeded. A study proposes an approach in this Report in order to manage the risk of interference.

For Wireless Broadband Low-Medium Power (WBB LMP) operating in 3800-4200 MHz

For the frequency band 3.8-4.1 GHz, all studies show sufficient margins covering at least the 6 dB safety margin as recommended by International Civil Aviation Organization (ICAO).

For the frequency band 4.1-4.2 GHz, all studies show sufficient margins covering at least the 6 dB ICAO safety margin, except for some types of medium power beamforming base station and radio altimeter scenarios (below 200 feet) where:

- Studies using Parameter Set 1 or Parameter Set 2 at 200 feet and 1000 feet show sufficient margins covering at least the 6 dB ICAO safety margin;
- However, a study using Parameter Set 2, which applies the 200 feet interference tolerance threshold below 200 feet, shows that unwanted emissions from these base stations do not meet the 6 dB ICAO safety margin for the modelled beamforming antenna configurations. The same study shows the 6 dB ICAO safety margin is fully covered for base station's positions greater than 1200 m from the runway threshold or 40 m laterally or with some improved out-of-band emission levels (further details are provided in Annex 3 of the ECC Report).

There are a number of differences between the results for Parameter Set 1 and Parameter Set 2. However, all studies found that lower heights are more critical than the Radio Altimeter at 1000 feet when considering potential interference. In addition, results are particularly sensitive to the assumptions for the Radio Altimeter antenna patterns particularly at high off-axis angles for low heights (below 200 feet).

Some administrations have also performed measurement campaigns, the results of which are provided for information in the Attachment to this ECC Report "Field measurement campaigns from some administrations related to MFCN in 3400-3800 MHz and Radio Altimeters in 4200-4400 MHz". The outcome of these campaigns finds no interference from MFCN transmissions to the Radio Altimeters, scenarios and aircraft tested.

0.2 TECHNICAL SUMMARY

The studies in this ECC Report are based on measurements for several Radio Altimeter (RA) models, with Interference Tolerance Thresholds (ITT) derived from published AVSI Reports [1] - [3]². The ITT of the various Radio Altimeter models differ by many dB. Only usage category 1 (UC1) Radio Altimeters have been considered as that category is "used in a wider variety of safety-critical systems that enable safe operation of commercial airliners in all-weather conditions" (as stated in AVSI Report Vol. I).

The analysis in this Report is complex and relies on many different technical parameters.

There was difficulty in reaching unanimous agreement on the Radio Altimeter parameters. Therefore, different studies used some different Radio Altimeter parameters which are described as Parameter Set 1 and 2 with ITT values for 200 and 1000 feet within this Report as the baseline, that were based on information provided to CEPT. Parameter Set 1 contains data on a variety of Radio Altimeter models primarily derived from AVSI Report Volume III. Parameter Set 2 contains data for the least resilient Radio Altimeter model based on AVSI Report Volume I and Volume II. Both Parameter Sets use different assumptions for the Radio Altimeter antenna. Section 5 provides further details on these and other factors.

² Aerospace Vehicle Systems Institute (AVSI) is an aerospace industry research cooperative that facilitates collaborative research and technology projects for its members. The referenced reports can be found at <https://avsi.aero>

Differences in the radio altimeter parameters between Parameter Set 1 and Parameter Set 2 (see section 4.3) and differences in the modelled scenarios result in a range of conclusions. Annex 1 contains the MFCN parameters used, and section 5 explains the high-level modelling scenario used.

The main scenario was modelled as a nominal Instrument Landing System (ILS) approach with associated Obstacle Limitation Surface (OLS).

Based on the above Radio Altimeter parameters, as well as typical Base Station parameters with antenna main beams pointing at or below the horizon, this Report derives the following conclusions for the modelled ILS approach scenario:

For MFCN operating in frequency band 3400-3800 MHz and Radio Altimeters in 4200-4400 MHz

In summary, the results show:

- All studies of spurious emissions (see ERC Recommendation 74-01 [4]) falling into the 4200-4400 MHz from MFCN operating in the 3400-3800 MHz frequency band show sufficient margins covering at least the 6 dB ICAO safety margin;
- Studies of potential blocking of the Radio Altimeter receiver:
 - using parameters and assumptions from Parameter Set 1 of ITT and RA antenna radiation patterns, (incl. roll up to ± 15 degrees), for macro MFCN BS operating in the 3400-3800 MHz frequency band with main beam pointing at or below the horizon (baseline assumptions), show sufficient margins covering at least the 6 dB ICAO safety margin;
 - using the ITT and Radio Altimeters antenna radiation patterns Parameter Set 2 of ITT and RA antenna radiation patterns, and where MFCN parameters deviate from Annex 1 (sensitivity analysis - e.g. 0° mechanical downtilt), there are some situations where the ITT at the Radio Altimeter is exceeded³;
 - extending Parameter Set 2 (e.g. applying the 200 feet ITT values below 200 feet) and where MFCN parameters deviate from Annex 1 (sensitivity analysis - e.g. extended electrical steering range beyond typical setup, etc.), there are additional situations where the ITT at the Radio Altimeter is exceeded^{Error!}
Bookmark not defined.

The difference in the results is primarily due to:

- the ITT values of the two Parameter Sets, which differ in the critical case by 4 dB at 200 feet;
- the difference between RA antenna pattern of Parameter Set 1 and Parameter Set 2, particularly at high off-axis angles for low heights (below 200 feet).

When comparing all the results of the 3400-3800 MHz blocking studies, in general the results are most sensitive to the following assumptions:

- The modelling of the antenna patterns for the Radio Altimeter and the pitch and roll assumptions in Parameter Sets 1 and 2;
- The breakpoint/ITT values assumed below 200 feet;
- Base Station parameters (in-block power levels, boresight direction, mechanical downtilt and vertical coverage range);
- BS location relative to RA position (OLS, terrain profile along the approach, BS height, glide slope, touchdown point);
- Variance of the Radio Altimeter ITT values for different RA models (in the order of 30 dB) with no or significantly less risk of interference for those more resilient models.

The measurement results contained in the Attachment to this ECC Report “Field measurement campaigns from some administrations related to MFCN in 3400-3800 MHz and Radio Altimeters in 4200-4400 MHz” for additional information, show no interference from MFCN to the Radio Altimeters, scenarios and aircraft tested.

For Wireless Broadband Low-Medium Power (WBB LMP) operating in 3800-4200 MHz (based on 3GPP and DECT-2020 NR) and Radio Altimeters in 4200-4400 MHz.

³ One administration has provided an example of its current national coordination measures to manage the risk of interference to RA (see Annex 3). Two other administrations have also implemented national measures while other administrations have not seen the need for national measures and therefore did not contribute on other possible mitigation measures.

For the frequency band 3800-4100 MHz:

- All studies show sufficient margins for unwanted emissions and Radio Altimeter blocking covering at least the 6 dB ICAO safety margin as recommended by International Civil Aviation Organization (ICAO);

For the frequency band 4100-4200 MHz:

- For non-AAS WBB LMP base stations, all studies show sufficient margins for unwanted emissions and Radio Altimeter blocking covering at least the 6 dB ICAO safety margin
- For AAS WBB LMP base stations:
 - the 6 dB ICAO safety margin is always met when considering Radio Altimeter Blocking (WBB LMP AAS in-band emissions);
 - Studies of Radio Altimeter protection at 200 and 1000 feet (baseline) show sufficient margins for unwanted emissions and Radio Altimeter blocking covering at least the 6 dB ICAO safety margin;

A study which applies the 200 feet ITT values below 200 feet (sensitivity analysis) shows that for unwanted emissions from WBB LMP falling in the 4200-4400 MHz band, base stations that were modelled with 4x4 and 8x8 AAS (non-sub-array) configurations close to the runway threshold can lead to situations where the 6 dB ICAO safety margin is not met by 13 dB (assuming the Block Edge Mask derived from ETSI TS 138 104 [47]). The same study shows the 6 dB ICAO safety margin is fully covered for BS positions greater than 1200 m from the runway threshold or 40 m laterally, or at all BS positions with emission levels, between 4200-4240 MHz, equal to the spurious emission limit. Details are provided in Annex 3.

TABLE OF CONTENTS

0	Executive summary	2
0.1	High-level Summary	2
0.2	Technical Summary	3
1	Introduction	12
2	Harmonised Framework for 5G MFCN and WBB LMP	13
2.1	Harmonised technical conditions	13
2.2	EC Harmonised timing	13
2.3	ETSI Harmonised Standards	13
3	5G MFCN and WBB LMP parameters	15
3.1	Base station parameters and deployment scenarios	15
3.1.1	For WBB LMP in the 3800-4200 MHz band	15
3.1.2	For MFCN in the 3400-3800 MHz band	15
4	Radio Altimeters	16
4.1	Role	16
4.2	Technical characteristics	17
4.2.1	Radio Altimeter Antenna	17
4.2.2	In-band (4200-4400 MHz) protection criteria	21
4.2.3	Blocking effect characteristics	21
4.2.4	ICAO Aviation Safety Factor	21
4.2.5	State Aircraft	21
4.3	Radio Altimeter Parameters for studies	21
4.3.1	Breakpoint to interference tolerance threshold	22
4.3.2	Breakpoint values (Parameter Set 1)	23
4.3.3	Breakpoint values (Parameter Set 2)	27
4.3.4	Radio Altimeter antenna assumptions	28
5	Description of interference scenarios	29
5.1	Aircraft Landing scenario	29
5.2	Obstacle Limitation Surface	29
5.3	Scenarios	30
6	Conclusions	31
6.1	High-level Summary	31
6.2	Technical Summary	32
ANNEX 1: ITU-R IMT deployment parameters and AAS model for sharing and compatibility studies		35
ANNEX 2: (Study A) Estimation of the potential interference from an aerial UE to Radio Altimeter...		40
A2.1	introduction	40
A2.2	RA performances as extracted from AVSI report Volume III	40
A2.3	Calculation of required separation distance	41
A2.4	Conclusions	42
ANNEX 3: (Study B) Radio Altimeter compatibility study with MFCN at 3.4-3.8 GHz and WBB LMP at 3.8-4.2 GHz for unwanted and blocking effect configurations with Radio Altimeter Parameter Set 2		43
A3.1	Base station parameters	43
A3.2	Radio Altimeter parameters	47
A3.3	Interference scenario and geometrical assumptions	48
A3.4	Methodology of the studies	49
A3.5	Results of compatibility studies for MFCN Base Stations (3400–3800 MHz)	57
A3.6	Results of compatibility studies for WBB LMP base station (3800–4100 MHz)	63

A3.7 Results OF COMPATIBILITY STUDIES FOR WBB LMP BASE STATION (4100-4200 MHz)	66
A3.8 Results OF COMPATIBILITY STUDIES FOR WBB LMP BASE STATION (4100-4200 MHz)	80
A3.9 Addendum: electronical tilts in AAS	83

ANNEX 4: (Study C) SIMULATION RESULTS FOR RADIO ALTIMETER 4200-4400 MHZ COEXISTENCE WITH MFCN OPERATED IN 3300-3800 MHZ USING MULTIPLE PARAMETER SETS..... 87

A4.1 Methodology	87
A4.2 Inputs and Assumptions	88
A4.3 Outputs	95
A4.4 Summary of the results.....	96
A4.5 Assumptions Summary.....	101
A4.6 Conclusions	101

ANNEX 5: (Study D) Simulation Results for Radio Altimeter 4200-4400 MHz coexistence with MFCN operated in 3400-3800 MHz with Radio Altimeter Parameter Set 1..... 103

A5.1 Summary	103
A5.2 Simulation assumptions.....	103
A5.3 Margins with respect to Radio Altimeter itt levels.....	113

ANNEX 6: Study E) Simulation Results for Radio Altimeter 4200-4400 MHz coexistence with WBB LMP operated in 3800-4200 MHz with Radio Altimeter Parameter Set 1..... 116

A6.1 Summary	116
A6.2 Simulation assumptions.....	117
A6.3 Simulation results	121

ANNEX 7: (Study F) study of MFCN 3.4-3.8 GHz and WBB LMP 3.8-4.2 GHz vs Radio Altimeters with Parameter Set 1

137	137
A7.1 Interference study for Radio Altimeters in the presence of MFCN 3.4-3.8 GHz and wbb Imp 3.8-4.2 GHz.....	137
A7.2 Parameters	137
A7.3 Methodology	138
A7.4 Baseline for Set 1 Parameters.....	140
A7.5 Sensitivity analysis	152
A7.6 Sensitivity to antenna assumptions	158
A7.7 Observations	159

ANNEX 8: (Study G) Compatibility study between MFCN operating in 3.4-3.8 GHz and Radio Altimeter operating in 4.2-4.4 GHz using Parameter Set 1

160	160
A8.1 Background.....	160
A8.2 Interference Tolerance Threshold (ITT)	160
A8.3 Parameters used in the study.....	162
A8.4 Interference SCENARIO.....	165
A8.5 Simulation results	166
A8.6 Parametric Analysis.....	171
A8.7 Summary	178

ANNEX 9: (Study H) Compatibility Study between WBB LMP Operating in 3.8-4.2 GHz and Radio Altimeter Operating in 4.2-4.4 GHz Using Parameter Set 1

179	179
A9.1 Background.....	179
A9.2 Interference scenario.....	179
A9.3 Interference Tolerance Threshold	181
A9.4 Parameters used in the study.....	183
A9.5 Simulation results	187
A9.6 Parametric Analysis.....	192
A9.7 Summary	194

ANNEX 10: (Study I) Calculation of Peak Interference Level from BS operating in the Frequency Range 3.4–3.8 GHz to RA Antenna at Altimeters of 200 feet and 1000 feet Using Parameter Set 1

195	195
A10.1 System characteristics for studies.....	195
A10.2 Calculation on Peak antenna pattern gain of BS based on operating angle range	199

A10.3 Methodology of calculation on receiving interference level of BS in Radio Altimeter 199
 A10.4 Calculation of peak interference level from MFCN BS 200
 A10.5 Conclusion 202

ANNEX 11: (Study J) Calculation of peak receiving interference level in Radio Altimeter from WBB LMP operating in the frequency band 3.8-4.2 GHz to RA antenna at altitudes of 200 feet and 1000 feet with SET1 parameters 203

A11.1 System characteristics for studies 203
 A11.2 Calculation on Peak antenna pattern gain of BS based on operating angle range 206
 A11.3 Methodology of calculation on receiving interference level of BS in Radio Altimeter 207
 A11.4 Calculation of peak interference level from WBB LMP BS 207
 A11.5 Conclusion 209

ANNEX 12: (Study K) Radio Altimeters and DECT-2020 NR Coexistence StUDY with Set2 parameters 210

A12.1 Introduction to DECT-2020 NR 210
 A12.2 Technical parameters 210
 A12.3 DECT-2020 NR study 212
 A12.4 Summary of results 213

ANNEX 13: (Study L) Coexistence analysis between mfcn in 3.4-3.8 ghz and Radio Altimeter in 4.2-4.4 ghz band 214

A13.1 Introduction 214
 A13.2 Technical characteristics 214
 A13.3 Methodology 219
 A13.4 Simulation results 221
 A13.5 Conclusion 226

ANNEX 14: Radio Altimeter Risk assessment considerations 227

A14.1 In-flights (depending on categories) 227
 A14.2 Classification of failure conditions in aviation 227

ANNEX 15: List of References 231

LIST OF ABBREVIATIONS

Abbreviation	Explanation
3GPP	The 3rd Generation Partnership Project
4G/LTE	4th generation of wireless cellular technology/Long-Term Evolution
5G/NR	5th generation of wireless cellular technology/New Radio
6G	6th generation of wireless cellular technology
AAS	Active antenna system
ACAS	Airborne Collision Avoidance Systems
AGL	Above ground level
AM	Amplitude modulation
AM(R)S	aeronautical mobile (route) service
AMS	Aircraft minimum surface
ARNS	Aeronautical radionavigation service
AWGN	Additive white Gaussian noise
AVSI	Aerospace vehicle systems institute
BEM	Block Edge Mask
BP	Breakpoint
BS	Base station
BW	Bandwidth
CDF	Cumulative distribution function
CEPT	European Conference of Postal and Telecommunications Administrations
CS	Certification specifications
DECT/ DECT-2020 NR	Digital Enhanced Cordless Telecommunications/ Digital Enhanced Cordless Telecommunications-2020 New Radio
EASA	European Union Aviation Safety Agency
ECO	European Communications Office
EECC	European Electronic Communications Code
EFIS	ECO Frequency Information System
ECC	Electronic Communications Committee
<i>e.i.r.p.</i>	Effective isotropically radiated power
EN	European Norm
ETSI	European Telecommunications Standardisation Institute
ETSO	European technical standard order
EU	European Union
EUROCAE	The European Organisation for Civil Aviation Equipment

FMCW	Frequency-modulated continuous wave radar
GPWS	Ground Proximity Warning Systems
HAGL	Height above ground level
HS	Harmonised Standard
IB	In-band
ICAO	International Civil Aviation Organization
HTAWS	Helicopter terrain awareness warning systems
IMT	International mobile telecommunications
ILS	Instrument landing system
ISRP	International Standards and Recommended Practices
ITM	Interference tolerance mask
ITT	Interference tolerance threshold
ITU-R	International Telecommunication Union – Radiocommunications Sector
LOC	Localiser
LOS	Line of sight
LTE	Long term evolution
MCL	Minimum coupling loss
MFCN	x
MIMO	Multiple Input Multiple Output
MOPS	Minimum Operational Performance Standards
MS	EU Member States
MSR	Multistandard radio
NCD	No computed data
NDA	No Data Available
NR	New radio
OCS	Obstacle clearance surface
OFS	Obstacle free surface
OJEU	Official Journal of the European Union
OLS	Obstacle limitation surface
OOB	Out-of-band
RA	Radio Altimeter
RED	Radio Equipment Directive
RF	Radio frequency
RFI	Radio Frequency Interference
RMS	Root mean square
RP	Reference point
RR	Radio Regulations

RSPG	Radio Spectrum Policy Group
RTCA	Radio technical commission for aeronautics
Rx	Receiver
SA	Sub-array
TAWS	Terrain Awareness Warning Systems
TCAS	Traffic Collision Avoidance Systems
TDP	Touch down point
TPC	Transmit power control
TRP	Total radiated power
Tx	Transmitter
UC	Usage Category
UE	User equipment
WAIC	Wireless Avionics Intra-Communications
WBB LMP	Terrestrial wireless broadband systems providing local area (i.e. low/medium power) network connectivity
WRC	World Radiocommunication Conference

1 INTRODUCTION

This Report is dealing with technical studies on compatibility between both MFCN operating in the 3.4 - 3.8 GHz frequency band and WBB LMP, terrestrial wireless broadband systems providing local-area (i.e. low/medium power) network connectivity, in the 3.8-4.2 GHz frequency band with a variety of Radio Altimeters (RA) operating in the 4.2-4.4 GHz. Parameters for these Radio Altimeters were agreed by CEPT for the scenarios that were studied based on information provided to CEPT (see section 5 for the Radio Altimeter details).

This Report assesses the susceptibility of deployed RA receivers operating in 4200-4400 MHz for the following compatibility scenarios:

- 1 Unwanted emissions from MFCN operating in the 3400-3800 MHz frequency band and WBB LMP operating in the 3800-4200 MHz frequency band into Radio Altimeters in the 4200-4400 MHz frequency band.
- 2 Impact of blocking of Radio Altimeters from 3400-3800 MHz MFCN in-band emissions and from 3800 - 4200 MHz WBB LMP in-band emissions.

2 HARMONISED FRAMEWORK FOR 5G MFCN AND WBB LMP

2.1 HARMONISED TECHNICAL CONDITIONS

Harmonised technical conditions for 5G MFCN have been developed on the basis of CEPT Report 67 [4], (Decision (EU) 2019/235 [8]), ECC Report 281 [9] and (ECC Decision (11)06 [10]). CEPT Report 67 has been developed on the basis of ECC Report 281 for the technical conditions. Both frameworks are fully consistent concerning the harmonised technical conditions based on least restrictive technical conditions (BEM: block edge mask) to be implemented in national authorisations for usage in the band 3.4-3.8 GHz.

In particular, for both ECC and EC framework and concerning the “in-block radiated power limits” as part of the BEM, there is no required power limit for non-AAS and AAS base stations. Nevertheless, administrations wishing to include a limit in their authorisation or to use a limit for coordination purpose may define such limits on a national basis.

In addition, ECC informed in June 2022 EASA and RTCA/EUROCAE on technical parameters of 5G IMT systems to be used during the development of updated Radio Altimeter standards, including the Minimum Operational Performance Standards (MOPS), (see document ECC (22)039, annexes 18 and 19 [10]) and the following information has been provided related to CEPT:

- The CEPT framework does not mandate specific technologies; however, in practice, mobile network operators deploy IMT systems such as 4G/LTE and 5G/NR and would be expected to deploy 6G when it becomes available;
- Some of the known regulatory in-band maximum base station output power limits have been provided. Deployments in some European countries have a transmit power up to 78 dBm *e.i.r.p.* in a bandwidth of 40 MHz. Base station transmit powers in the future could exceed current power levels. Any change of regulation in future is a result of complex process including for example sharing studies.

In September 2024, the ECC requested updates from CEPT administrations on maximum Base Station transmit power in operation in the 3400-3800 MHz frequency band. The responses from some European countries are confirming that the maximum base station *e.i.r.p.* from 2022 remains appropriate, so 78 to 82 dBm/100 MHz used in this Report are representative of base stations in CEPT countries.

CEPT has developed CEPT Report 88 [46] "Report from CEPT to the European Commission in response to the Mandate on shared use of 3800-4200 MHz by terrestrial wireless broadband systems providing local-area network connectivity (WBB LMP)".

2.2 EC HARMONISED TIMING

The European Electronic Communications Code (EECC) required a coordinated timing of assignments in the 3.4-3.8 GHz frequency band in order to support development of 5G in Europe (see Article 54) [12]. The state of the assignments is monitored by the European Commission (EC) on the basis of information provided by European Union (EU) Member States (see [RSPG24-002 \[13\]](#)).

More detailed information of authorisations granted by CEPT administrations, including EU member States, is available in the EFIS database managed by the European Communications Office (ECO) (see ECO Report 03 [14]).

2.3 ETSI HARMONISED STANDARDS

The European Telecommunications Standards Institute (ETSI) develops standards which, when appropriate and further to the approval by the European Commission, are published as harmonised standards (HS) in the Official Journal of the EU. Those HS support the implementation of the conformity to the Radio Equipment Directive (RED) and single market of radio equipment in the European Union.

In response to a question from CEPT, ETSI clarified that the 5G Base Stations (NR, LTE and MSR) operating band unwanted emission limit inside the operating band 3400-3800 MHz also extends outside the band to an offset of 40 MHz for both non-AAS and AAS BS. Outside this offset, the general spurious emission limit of -

main chapters and its subsections 30 dBm/MHz applies, specified as TRP for AAS and conducted power to the antenna port for non-AAS. This limit is now being introduced in the EN 301 908-24 [15] for 5G Base Stations. This EN, adopted by ETSI and proposed to the European Commission is expected to be published in Official Journal of the European Union (OJEU) as Harmonised Standard (HS).

At the time of publication of this Report the published European Harmonised Standard does not include the frequency band 3.8-4.2 GHz. It is expected that the existing Harmonised Standard will be updated or a set of new Harmonised Standards for WBB LMP in 3.8-4.2 GHz will be developed following the publication of CEPT Report 88 [46].

3 5G MFCN AND WBB LMP PARAMETERS

3.1 BASE STATION PARAMETERS AND DEPLOYMENT SCENARIOS

3.1.1 For WBB LMP in the 3800-4200 MHz band

The deployment scenarios and Base Station (BS) parameters with the antenna model are given in the ECC Report 358 [17]. The in-block medium power is limited to an *e.i.r.p.* of 51 dBm/100 MHz. Active Antenna Systems (AAS) for low power BS is currently not foreseen by manufacturers in that frequency range.

The assumptions for the unwanted emissions (above 4.2 GHz) may depend on the in-block power as well as the technology e.g. 3GPP or DECT-2020 NR and may differ in the studies in the Annexes.

3.1.2 For MFCN in the 3400-3800 MHz band

The Block Edge Mask (BEM) and frequency arrangement for the 3400-3800 MHz frequency band are given in ECC Decision (11)06 [10].

Annex 1 provides the parameters from ITU-R documentation considered as a baseline for compatibility studies, however some studies have used different assumptions that are explained in the relevant study.

4 RADIO ALTIMETERS

Within the International Telecommunication Union (ITU) Radio Regulations (RR) [16], the frequency band 4200-4400 MHz is globally allocated to the aeronautical radionavigation service (ARNS) subject to Footnote No. 5.438 (“Use of the frequency band 4200-4400 MHz by the aeronautical radionavigation service is reserved exclusively for Radio Altimeters installed on board aircraft and for the associated transponders on the ground. (WRC-15)”) 4. Article 1.46 of the RR defines the aeronautical radionavigation service as “a radionavigation service intended for the benefit and for the safe operation of aircraft”.

4.1 ROLE

A Radio Altimeter (RA) is a downward-looking radar ranging system that measures the height of an aircraft above terrain and obstacles with a high degree of accuracy⁵, integrity, and availability, during all phases of the flight. Radio Altimeters are used on all types of aircraft, including passenger service and cargo airplanes and helicopters. Radio Altimeter systems are designed to operate for the entire life of the aircraft in which they are installed. The installed life can exceed 30 years, resulting in a wide range of equipment age, performance, and tolerance to radio frequency interference among the Radio Altimeters currently in operation worldwide.

The Radio Altimeter provides height above ground level (HAGL) measurements to other aircraft safety, navigation, and automation systems including, but not limited to, Terrain Awareness Warning Systems (TAWS), Ground Proximity Warning Systems (GPWS), Airborne Collision Avoidance Systems (ACAS), and Traffic Collision Avoidance Systems (TCAS). HAGL measurements are also used for cockpit situational awareness and automated flight controls. Many of these systems and functions are required by regulation to allow operation of a passenger-carrying aircraft⁶.

While a Radio Altimeter is active in all phases of operation, the aircraft is especially reliant on accurate and timely HAGL information during critical phases of flight including take-off, climb, final approach, and landing. For example, landing in low-visibility conditions is only possible using flight automations enabled by the Radio Altimeter. These critical phases of flight bring an aircraft in closest proximity to ground based emitters. Thus, it is necessary to accurately assess the risk for interference using a level of caution commensurate with the preservation of life.

A Radio Altimeter works by transmitting a signal toward the ground below the aircraft, receiving the reflected signal, and measuring time delay⁷ to determine the height above ground. Multiple factors affect the energy that is reflected back to the aircraft including the flatness of the terrain, surface features, surface reflectivity, and the field of view of the Radio Altimeter transmit and receive antennas. Furthermore, the Radio Altimeter must maintain its performance in all types of weather while the aircraft is performing flight manoeuvres that introduce pitch and roll. These factors combine to create a wide variation in the observed signal loss during the transmit-reflect-receive loop, requiring Radio Altimeters to operate with a dynamic range well beyond 100 dB.

⁴ In addition, the frequency band is shared with Wireless Avionics Intra-Communications (WAIC) systems. WRC-15 allocated the frequency band 4200-4400 MHz to the aeronautical mobile (route) service (AM(R)S) subject to footnote 5.436 (“Use of the frequency band 4200-4400 MHz by stations in the aeronautical mobile (R) service is reserved exclusively for wireless avionics intra-communication systems that operate in accordance with recognized international aeronautical standards. Such use shall be in accordance with Resolution 424 (WRC-15).”).

⁵ For example, Radio Altimeters designed for use in automated landing systems are required to achieve an accuracy of 0.9 m (3 feet).

⁶ ICAO Annex 6 Part 1 Chapter 6 [18] specifies the mandatory carriage of GPWS and TAWS with forward looking terrain functions for certain aircraft weight categories. Additionally, in commercial and civil aviation, the ubiquitous usage of Radio Altimeters is not solely a matter of convenience. For many types of aircraft operations, such usage is either explicitly or indirectly required by regulations and certification specifications (CS). For example, Regulation (EU) No 965/2012, Annex IV, Part-CAT, Subpart D, Section 1, CAT.IDE.A.150 [19] indicates: “Turbine-powered aeroplanes having an MCTOM of more than 5 700 kg or an MOPSC of more than nine shall be equipped with a TAWS that meets the requirements for Class A equipment as specified in an acceptable standard.” And European Union Aviation Safety Agency (EASA) CS-ACNS issue 4, Subpart E, Section 1, CNS.E.TAWS.010 Required Functions and Interfaces “The use of Radio Altimeter sensor input.” [20]. In addition, operations such as Category II or Category III Instrument Landing System (ILS) approaches require the use of at least one radar altimeter. Radio Altimeters used by EASA certified aeroplanes must comply with European technical standard order ETSO-C87A [21] which defines certification testing procedures and the required minimum performance of the equipment. In particular, ETSO-C87A relies on EUROCAE document ED-30 [22] concerning accuracy requirements.

⁷ The time delay is measured either directly for pulsed modulation altimeters or by converting a frequency delta to a time delay using a linearly chirped signal for frequency modulation continuous wave altimeters.

Radio altimetry uses the full 200 MHz allocated bandwidth between 4200-4400 MHz to achieve the required levels of accuracy, integrity, and availability. Up to three redundant Radio Altimeters can operate simultaneously and independently from one another on board a single aircraft to ensure availability of accurate HAGL measurements. Methods used to avoid interference between redundant systems may cause the occupied bandwidth on a single aircraft to be greater than the required bandwidth of any single Radio Altimeter.

4.2 TECHNICAL CHARACTERISTICS

Technical characteristics for currently deployed Radio Altimeters are described in several publicly available documents from ITU-R, RTCA, Inc., European Organisation for Civil Aviation Equipment (EUROCAE), and the Aerospace Vehicle Systems Institute (AVSI).

Recommendation ITU-R M.2059-0 [21] contains Radio Altimeter operational and technical characteristics in Annex 1 and Annex 2, and Radio Altimeter protection criteria in Annex 3 [21].

Additional information describing technical characteristics of installed Radio Altimeters and considerations for application to sharing studies are contained in Report ITU-R M.2319-0, annex 3 [22].

RTCA Paper No. 274-20/PMC-2073 [23] analyses the risk of interference from IMT emissions in the frequency band 3700-3980 MHz based on interference tolerance measurements of existing altimeters performed by AVSI and technical characteristics for IMT equipment defined in ITU-R documents and 3GPP standards for different possible encounter scenarios.

AVSI reported measured RFI tolerance thresholds for existing Radio Altimeters in Volumes I – III of the Project AFE 76s2 Report [1] - [3]; the AVSI AFE 76s2 report defines three Usage Categories (UC)⁸.

While Radio Altimeter technical characteristics are available in each of the aforementioned sources, section 4.3 describes two Radio Altimeter parameter sets derived from these, which are used for the sharing and compatibility studies contained in this Report. Some studies extended beyond these two agreed Radio Altimeter parameter sets as explained in the relevant study.

4.2.1 Radio Altimeter Antenna

Currently, no standard exists that defines common performance requirements for Radio Altimeter antennas. However, several documents provide information about Radio Altimeter antennas that are useful for compatibility studies.

4.2.1.1 Recommendation ITU-R M.2059

Recommendation ITU-R M.2059, tables 1 and 2 [21] indicate that representative Radio Altimeters use antenna designs that provide 8 to 13 dBi of maximum gain and between 35 and 60 degrees of coverage to the 3 dB point (half power) of the antenna pattern. ITU-R Recommendation M.2059 states:

“The peak gain, as provided in Tables 1 and 2, of the Radio Altimeter antenna should be used if propagation paths are within $\pm 30^\circ$ of a vector orthogonal to the bottom of the aircraft. Sharing and compatibility studies shall take into account the fact that aircraft angle position can reach $\pm 45^\circ$ in roll and $\pm 20^\circ$ in pitch. Outside this angle range, the gain of the Radio Altimeter should be based on antenna characteristics.”

⁸ The Usage Categories are defined in the AVSI AFE 76s2 report as:

UC1: RAs installed in larger single-aisle and wide-body commercial air transport airplanes

UC2: RAs installed in all other fixed-wing aircraft not included in Usage Category 1, including regional air transport, business aviation, and general aviation airplanes

UC3: RAs installed in transport and general aviation helicopters

4.2.1.2 Report ITU-R M.2319

Report ITU-R M.2319-0, annex 3 [24] contains a description of Study 2 (on compatibility between WAIC and RA), and section A.3.1.1 describes assumptions concerning the Radio Altimeter antenna characteristics in the frequency band 4200-4400 MHz and Radio Altimeter antenna installation locations to support sharing studies. Report ITU-R M.2319-0 states:

“For the Radio Altimeter antenna pattern a circular-symmetric parabolic shape is assumed. It is parameterized by Φ_{3dB} , the 3dB-beamwidth and $G_{RA,dBi}$, the isotropic antenna gain as stated in Tables A-3.1 and A-3.2. Because of its symmetry a single incident angle Φ , which represents the combination of azimuth and elevation, is required in order to specify the antenna gain $G_{RA,dBi}$. Hence the parabolic antenna pattern is described by:

$$G_{RA,dBi}(\Phi) = -\frac{12}{\Phi_{3dB}^2} \Phi^2 + G_{RA,dBi} \quad (A-3.6)”$$

4.2.1.3 RTCA Paper No. 274-20/PMC-2073

RTCA Paper No. 274-20/PMC-2073 [25] provides test data on Radio Altimeter antenna patterns measured at 3850 MHz and 4300 MHz. The test was performed on two separate altimeter antenna models from two different manufacturers. Figures 6-11 and 6-12 of the RTCA paper provide the radio altimeter reference antenna pattern for the 3700-3980 MHz (3.7-3.98 GHz) band and the 4200-4400 MHz (4.2-4.4 GHz) band respectively. Screen captures of Figures 6-11 and 6-12 are presented in Figure 1 and Figure 2.

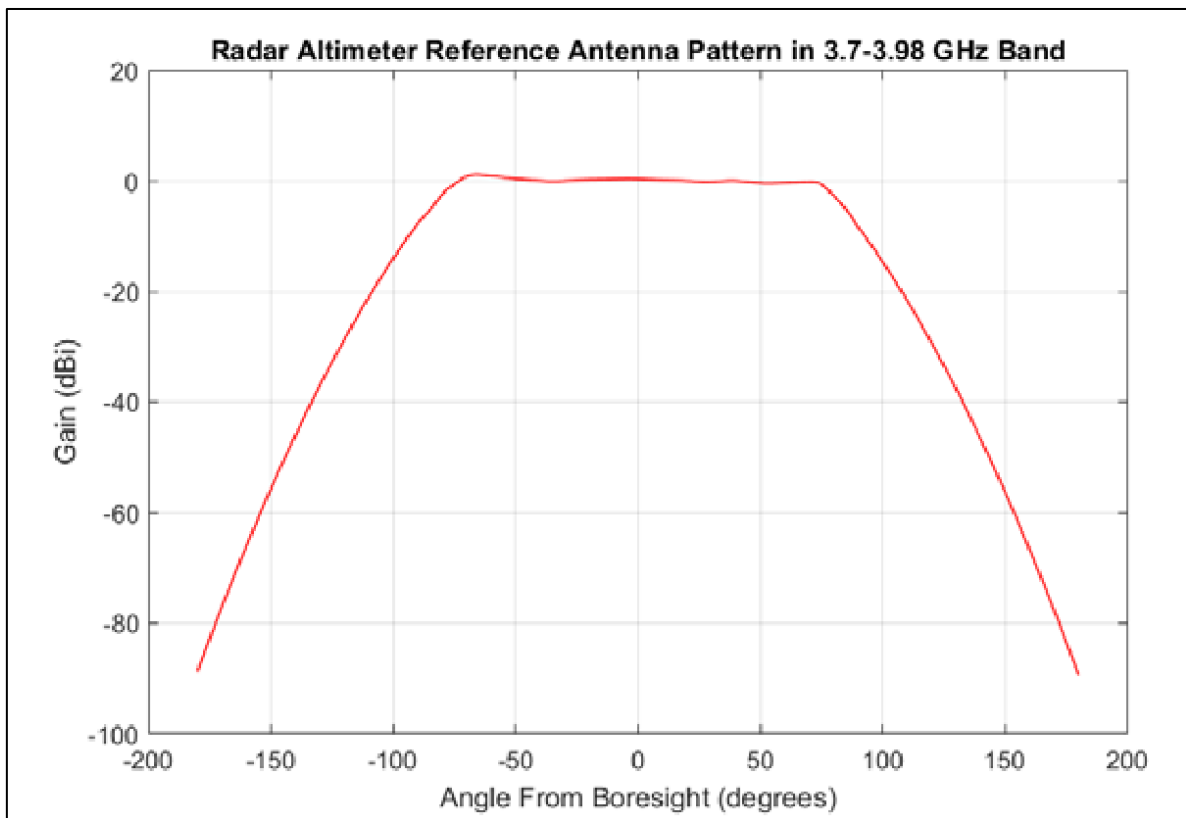

Figure 1: Extract from RTCA Paper No. 274-20/PMC-2073, figure 6-11
 ©RTCA, Inc. Used with permission. All rights reserved.
 (Note: The terms "Radar Altimeter" and "Radio Altimeter" are interchangeable)

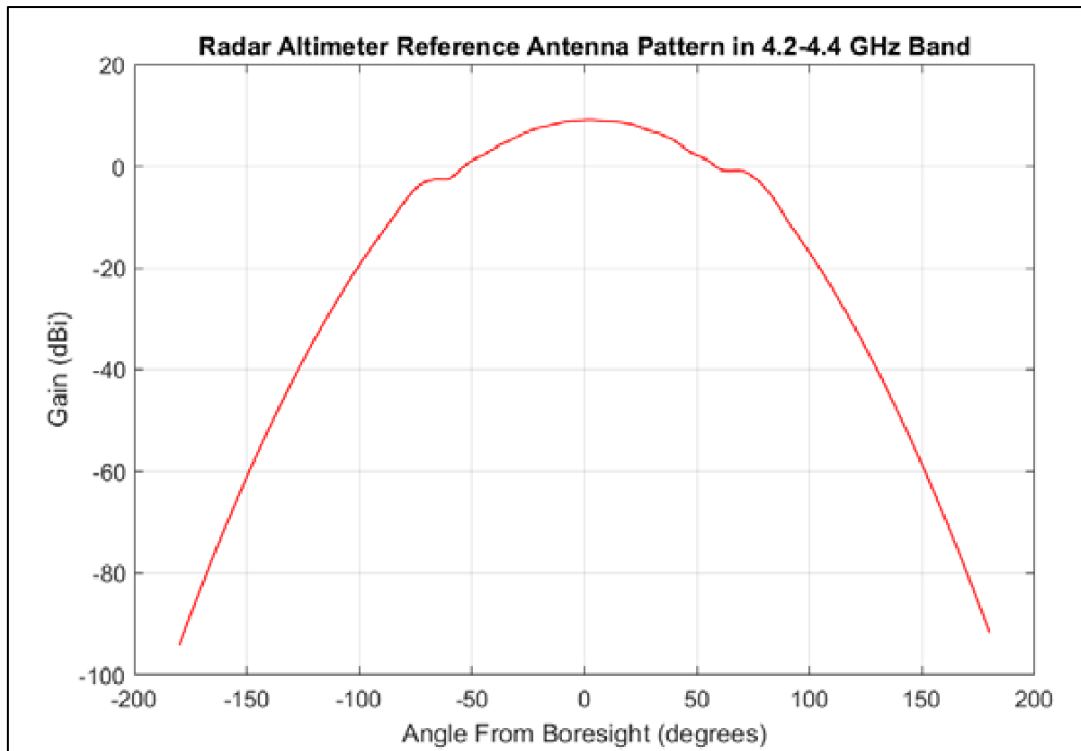

Figure 2: Extract from RTCA Paper No. 274-20/PMC-2073, figure 6-12
 ©RTCA, Inc. Used with permission. All rights reserved.
 (Note: The terms "Radar Altimeter" and "Radio Altimeter" are interchangeable)

The RTCA paper (page 131 and 132) also includes additional information (measured data) on the antenna radiation pattern shown in Figure 3 and Figure 4, provided by aviation experts.

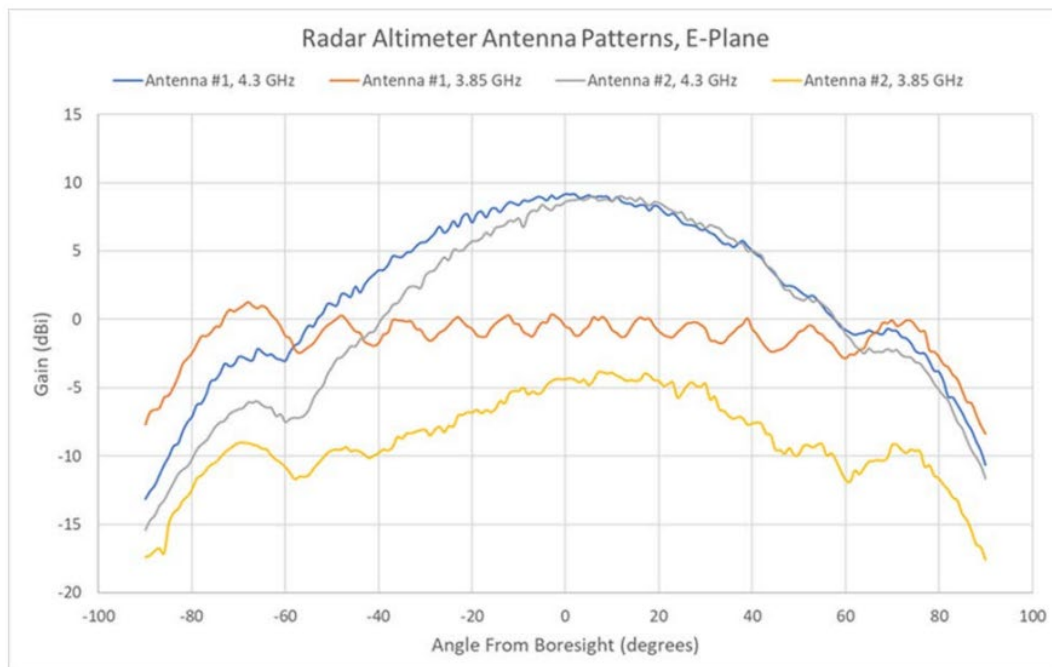
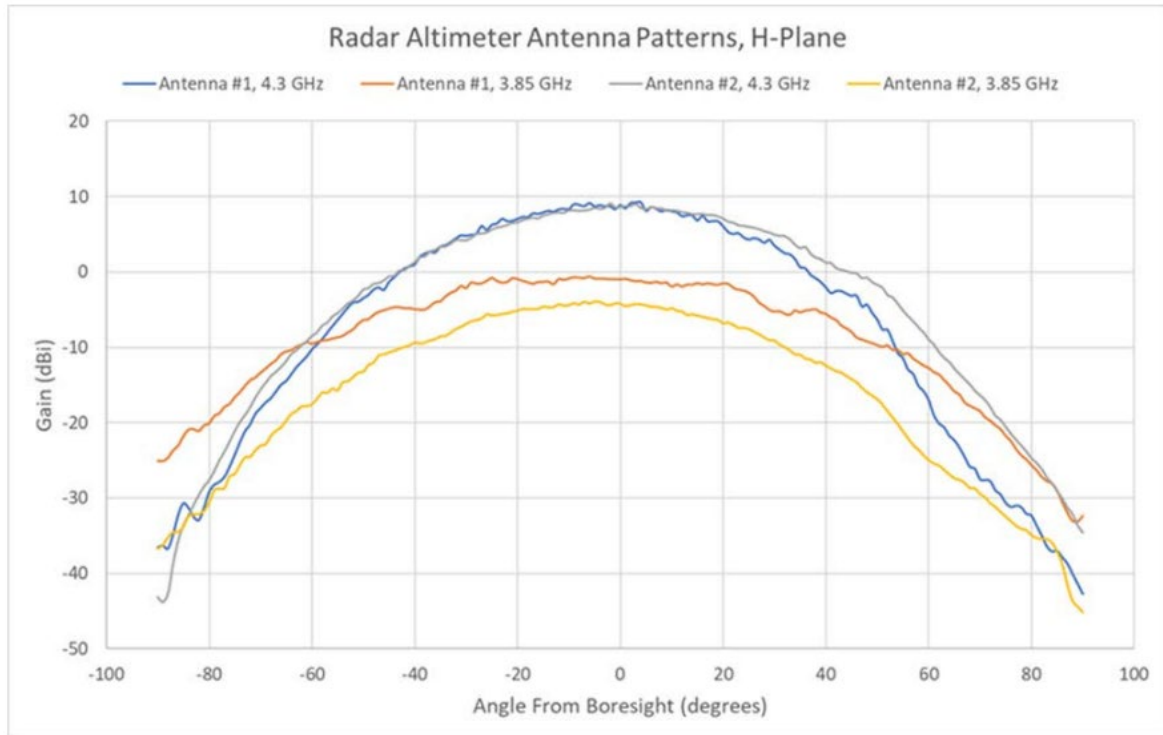
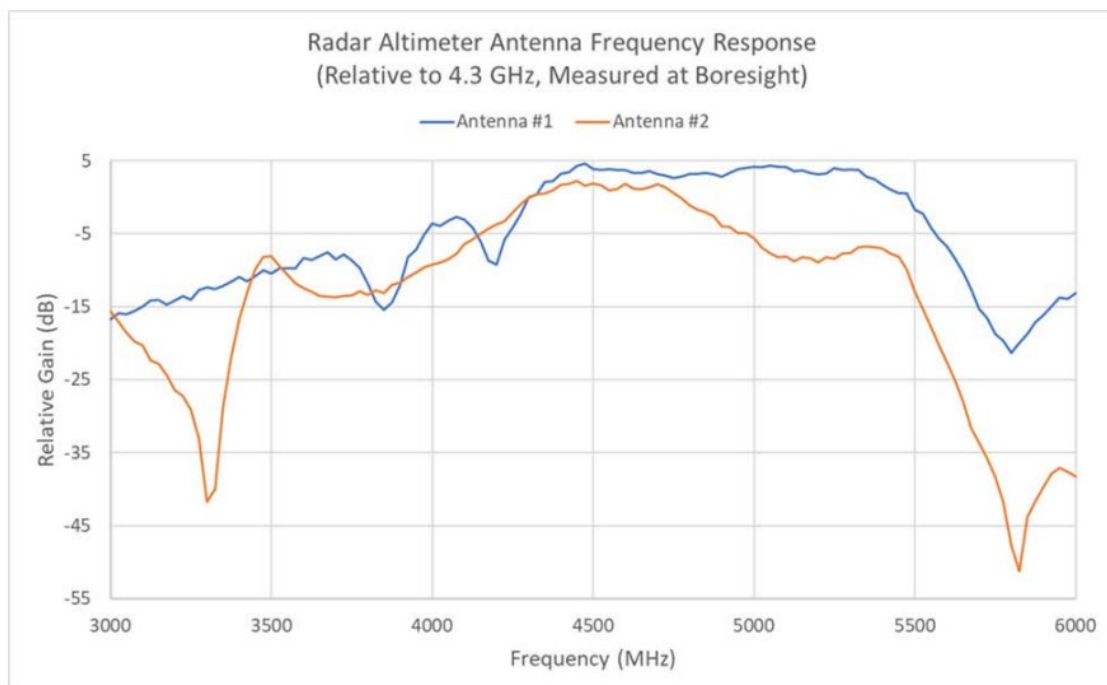

Figure 3: Extract from RTCA Paper No. 274-20/PMC-2073, page 131
 ©RTCA, Inc. Used with permission. All rights reserved.
 (Note: The terms "Radar Altimeter" and "Radio Altimeter" are interchangeable)



**Figure 4: Extract from RTCA Paper No. 274-20/PMC-2073, page132
©RTCA, Inc. Used with permission. All rights reserved.
(Note: The terms "Radar Altimeter" and "Radio Altimeter" are interchangeable)**

The frequency response for the radio altimeter antenna is also provided as shown in Figure 5.



**Figure 5: Extract from RTCA Paper No. 274-20/PMC-2073, page 132
©RTCA, Inc. Used with permission. All rights reserved.
(Note: The terms "Radar Altimeter" and "Radio Altimeter" are interchangeable)**

4.2.2 In-band (4200-4400 MHz) protection criteria

4.2.2.1 In-Band Protection Criteria from Recommendation ITU-R M.2059

Recommendation ITU-R M.2059-0, annex 3 [21] contains three primary electromagnetic interference coupling mechanisms between Radio Altimeters and interfering signals from other transmitters: "receiver front-end overload", "receiver desensitization", and "false altitude reports" .

4.2.2.2 In-Band Protection Criteria from AVSI AFE 76s2 Report

The AVSI AFE 76s2 Report Volume II [2] and III [3] are the basis to derive the in-band protection criteria to be used in sharing studies as listed in section 4.3.

4.2.3 Blocking effect characteristics

4.2.3.1 RF selectivity of radio altimeter from Recommendation ITU-R M.2059-0

The RF selectivity for Radio Altimeters is provided in Recommendation ITU-R M.2059-0, table 3 [21].

4.2.3.2 Blocking characteristics from AVSI AFE 76s2 Report

The AVSI AFE 76s2 Report Volume I [1] and III [3] are the basis to derive the blocking characteristics to be used in sharing studies as listed in section 4.3.

4.2.4 ICAO Aviation Safety Factor

ICAO document 9781 AN/957 Volume I contains "ICAO spectrum strategy and policy statements relevant to the aviation requirements for radio frequency spectrum, as approved and amended by the ICAO Council" [24]. Section 9.2.22 states the ICAO position on an aviation safety factor, also referred to as a safety margin; section 9.2.22 states:

"Aeronautical safety applications are required to have continued operation through worst case interference, so all factors which contribute to harmful interference should be considered in analyses involving those applications. An aviation safety margin is included in order to address the risk that some such factors cannot be foreseen (for example impacts of differing modulation schemes). This margin is applied to the system protection criteria to increase the operational assurances to the required level. Traditionally for aviation systems/scenarios an aviation safety margin of 6–10 dB is applied. Until established on the basis of further study on a case-by-case basis, an aviation safety margin of not less than 6 dB should be applied."

4.2.5 State Aircraft

State aircraft are aircraft operated by the Government for sovereign, non-commercial purposes such as military, customs, and police services. Military aircraft are afforded status as state aircraft. State aircraft are not specifically considered in this report, but the conclusions in this report may apply to such aircraft equipped with radio altimeters that have ITT parameters are similar to those for civil aircraft for the given scenario.

4.3 RADIO ALTIMETER PARAMETERS FOR STUDIES

The Radio Altimeter parameters contained within this section are used for the compatibility studies contained in the annexes of this Report. The Parameter Sets below are based on Usage Category 1 (UC1) Radio Altimeters. They encompass interference tolerance thresholds and antenna radiation patterns according to the frequency bands considered.

Parameter Set 1 provides RA parameters for a variety of Radio Altimeter models primarily derived from AVSI AFE 76s2 Report Volume III [3]. Parameter Set 2 provides a generic parameter value based on the Radio Altimeter models from AVSI AFE 76s2 Report Volumes I [1] and II [2] that are least resilient to interference. Parameter Sets 1 and 2 provide different RA antenna pattern assumptions based on certain information in the RTCA Paper No. 274-20/PMC-2073 [23] and Report ITU-R M.2319-0 [22]. Parameter Sets for these Radio Altimeters were agreed by CEPT for the scenarios that were studied based on information provided to CEPT.

The Radio Altimeter breakpoint is defined based on the criteria in the AVSI AFE 76s2 Report Vol I [1] as:

- Mean Error Criterion (Section 2.3.4.1): “The AUT (Altimeter Under Test) was considered to “break” (...) when the mean error exceeds 0.5%”;
- Percentile Criterion (Section 2.3.4.2): (...) “when the 1st percentile trace drops below -2% or the 99th percentile trace exceeds +2%”;
- No Computed Data (NCD) criterion (Section 2.3.4.3): (...) “the lowest 5G interference power that produces any height reading label NCD during the RF power ON period is a breakpoint”.

The breakpoints are defined for specific frequencies outside the Radio Altimeter frequency range of operation as well as frequencies within the Radio Altimeter band. The breakpoint covers in-band interference from unwanted emissions, as well as the interference caused by signals falling outside of the frequency band of Radio Altimeters due to a mechanism similar to the blocking effect.

Breakpoints are provided in the following sections for two heights, 200 feet and 1000 feet. These breakpoints are taken from publicly available and accessible sources for the different frequencies and heights for a range of fielded and operational UC1 models and are considered in this Report as baseline.

Some studies considered heights between 200 feet and 1000 feet and also below 200 feet. Some concerns were expressed about the extension of the breakpoints to these other heights and whether this was representative or not. Some other views were expressed that such an extension can be considered.

4.3.1 Breakpoint to interference tolerance threshold

The provided breakpoints in sections 4.3.2 and 4.3.3 can be converted to an Interference Tolerance Threshold (ITT) using Equation 22.

$$ITT = BP - BTI_f - EE_f - U&T_f$$

Equation 1

Where:

- *ITT*: The interference tolerance threshold at the input to the Radio Altimeter transceiver receive port. The interference tolerance threshold is defined for a specific height and frequency offset as the highest power for which performance is still acceptable (dBm/MHz);
- *BP*: The breakpoint of the Radio Altimeter (dBm/MHz);
- *BTI_f*: A *BP*-to-*ITT* backoff factor that accounts for the step-size used in the AVSI testing (dB);
- *EE_f*: An experimental error factor (dB);
- *U&T_f*: A unit-to-unit and temperature interference tolerance performance variation factor (dB).

The ITT and breakpoints are derived considering an MFCN bandwidth of 100 MHz in the 3.4-4.2 GHz frequency range. The ITT and breakpoints for the 4.2-4.4 GHz frequency range are indicated in the tables below and are derived considering the tested Radio Altimeter bandwidth (160 MHz in many cases) and conversion details are provided below.

The necessary constants to convert the RA breakpoints to interference tolerance thresholds for the listed RA models are provided in Table 1.

Table 1: Constants for Equation 1 for Specified Radio Altimeter Models

Parameter	Unit	Value
BTI_f	dB	1
EE_f	dB	1
$U\&T_f$	dB	0 (for Radio Altimeter model L and X) 4 (for Radio Altimeter model T, U, and Y) 0 or 4 (for Radio Altimeter model F, with justification)

4.3.2 Breakpoint values (Parameter Set 1)

4.3.2.1 Frequency band 3.4-3.8 GHz

Table 2: UC1 breakpoints between 3.4-3.8 GHz at 200 feet AGL in dBm/MHz

Radio Altimeter model	3.4-3.7 GHz	3.7-3.8 GHz	Source
F	-21 (3.4 GHz Worst-case sample)	-30 (3.8 GHz Worst-case sample)	AVSI AFE 76s2 Report Vol III [3] Figure 9-9
L	NB (> 0) (For 3700 MHz Percentile Criterion >2% Error)	NB (> 0) (For 3750 MHz Percentile Criterion >2% Error)	AVSI AFE 76s2 Report Vol III [3] Table 8-8
T	NB (> -21.2) (For 3650 MHz Percentile Criterion >2% Error)	NB (> -21.0) (For 3750 MHz Percentile Criterion >2% Error)	AVSI AFE 76s2 Report Vol III [3] Table 6-6
X	NB (> -20) (For 3650 MHz Percentile Criterion >2% Error)	NB (> -20) (For 3750 MHz Percentile Criterion >2% Error)	AVSI AFE 76s2 Report Vol III [3] Table 8-10
U	NB (> -21.2) (For 3650 MHz NCD Criterion)	NB (> -21.0) (For 3750 MHz NCD Criterion)	AVSI AFE 76s2 Report Vol III [3] Table 6-9
Y	NDA	-29 (For 3750 MHz)	AVSI AFE 76s2 Report Vol I [1] Table 3-1

Note: NB (> VALUE) refers to "No Breakpoint", meaning normal RA operation up to the maximum 5G signal level tested, where VALUE is the maximum power tested, and the breakpoint would be higher than this level. This tested power level should not be considered as a breakpoint.

Note: The breakpoints are converted to dBm/MHz.

Note: NCD refers to "no computed data".

Note: NDA refers to "no data available," meaning testing was not conducted for the frequency range.

Note: Model L was not tested below 3.6 GHz. For this model it is assumed that the breakpoint power is equivalent for frequency bands farther from the 4.2 GHz band edge in the case that no data is available. This does not imply monotonic behaviour has been confirmed for these Radio Altimeters.

Note: For Model X, breakpoints are measured at AGL = 250 feet in AVSI AFE 76s2 Report Vol III.

Note: The breakpoints consider a percentile criterion of +/-2% error and an NCD criterion and do not consider a criterion of a mean error of 0.5%. The mean error deviation of 0.5% is more stringent than the Radio Altimeter height accuracy of +/-3%, across 95% of measured observations that is defined in RTCA DO-155 [27] / EUROCAE ED-30 [1].

Table 3: UC1 breakpoints between 3.4-3.8 GHz at 1000 feet AGL in dBm/MHz

Radio Altimeter model	3.4-3.7 GHz	3.7-3.8 GHz	Source
F	-24 (3.7 GHz Worst-case sample)	-34 (3.8 GHz Worst-case sample)	AVSI AFE 76s2 Report Vol III [3] Figure 9-10
L	NB (> 0) (For 3700 MHz Percentile Criterion >2% Error)	NB (> 0) (For 3750 MHz Percentile Criterion >2% Error)	AVSI AFE 76s2 Report Vol III Table 8-13
T	NB (> -21.9) (For 3650 MHz Percentile Criterion >2% Error)	NB (> -21.0) (For 3750 MHz Percentile Criterion >2% Error)	AVSI AFE 76s2 Report Vol III Table 6-18
X	NB (> -20.0) (For 3650 MHz Percentile Criterion >2% Error)	-24 (For 3750 MHz Percentile Criterion >2% Error at -40°C)	AVSI AFE 76s2 Report Vol III Table 8-14
U	NB (> -21.2) (For 3650 MHz NCD Criterion)	NB (> -21.0) (For 3750 MHz NCD Criterion)	AVSI AFE 76s2 Report Vol III Table 6-21
Y	NDA	-35 (For 3750 MHz)	AVSI AFE 76s2 Report Vol I [1] Table 3-1

Note: NB (> VALUE) refers to “No Breakpoint”, meaning normal RA operation up to the maximum 5G signal level tested, where VALUE is the maximum power tested, and the breakpoint would be higher than this level. This tested power level should not be considered as a breakpoint.
 Note: The breakpoints are converted to dBm/MHz.
 Note: NCD refers to “no computed data”.
 Note: NDA refers to “no data available,” meaning testing was not conducted for the frequency range.
 Note: Model L was not tested below 3.65 GHz. For these models it is assumed that the breakpoint power is equivalent for frequency bands farther from the 4.2 GHz band edge in the case that no data is available. This does not imply monotonic behaviour has been confirmed for these Radio Altimeters.
 Note: The breakpoints consider a percentile criterion of +/-2% error and an NCD criterion and do not consider a criterion of a mean error of 0.5%. The mean error deviation of 0.5% is more stringent than the Radio Altimeter height accuracy of +/-3%, across 95% of measured observations that is defined in RTCA DO-155 / EUROCAE ED-30.

4.3.2.2 Frequency band 3.8-4.2 GHz

Table 4: UC1 breakpoints between 3.8-4.2 GHz at 200 feet AGL in dBm/MHz

Radio Altimeter model	3.8-4.1 GHz	4.1-4.2 GHz	Source
F	-35 (For 4 GHz Worst-case sample)	-31 (For 4.1 GHz Worst-case sample)	AVSI AFE 76s2 Report Vol III Figure 9-9
L	-8 (For 4000 MHz Percentile)	NDA	AVSI AFE 76s2 Report Vol III Table 8-8

Radio Altimeter model	3.8-4.1 GHz	4.1-4.2 GHz	Source
	Criterion >2% Error)		
T	NB (> -29.9) (For 4050 MHz Percentile Criterion >2% Error)	NB (> -19.8) (For 4150 MHz Percentile Criterion >2% Error)	AVSI AFE 76s2 Report Vol III Table 6-6
X	-28 (For 3950 MHz Percentile Criterion >2% Error at +25°C)	NDA	AVSI AFE 76s2 Report Vol III Table 8-10
U	NB (> -19.8) (For 4050 MHz NCD Criterion)	NB (> -19.8) (For 4150 MHz NCD Criterion)	AVSI AFE 76s2 Report Vol III Table 6-9
Y	-28 (For 3850 MHz)	NDA	AVSI AFE 76s2 Report Vol I Table 3-1

Note: NB (> VALUE) refers to "No Breakpoint", meaning normal RA operation up to the maximum 5G signal level tested, where VALUE is the maximum power tested, and the breakpoint would be higher than this level. This tested power level should not be considered as a breakpoint.

Note: The breakpoints are converted to dBm/MHz.

Note: NDA refers to "no data available", meaning testing was not conducted for the frequency range.

Note: NCD refers to "no computed data".

Note: Model X was tested at an height of 250 feet AGL.

Note: Model L was tested up to a frequency of 4.05 GHz. Model X was tested up to a frequency of 4.00 GHz. Model Y was tested up to a frequency of 3.98 GHz.

Note: The breakpoints consider a percentile criterion of +/-2% error and an NCD criterion and do not consider a criterion of a mean error of 0.5%. The mean error deviation of 0.5% is more stringent than the Radio Altimeter height accuracy of +/-3%, across 95% of measured observations that is defined in RTCA DO-155 / EUROCAE ED-30.

Table 5: UC1 breakpoints between 3.8-4.2 GHz at 1000 feet AGL in dBm/MHz

Radio Altimeter model	3.8-4.1 GHz	4.1-4.2 GHz	Source
F	-40 (For 4 GHz Worst-case sample)	-37 (For 4.1 GHz Worst-case sample)	AVSI AFE 76s2 Report Vol III Figure 9-10
L	-7 (For 4 GHz NCD Criterion)	NDA	AVSI AFE 76s2 Report Vol III Table 8-13
T	-30.9 (For 4050 MHz Percentile Criterion >2% Error)	-33.8 (For 4150 MHz Percentile Criterion >2% Error)	AVSI AFE 76s2 Report Vol III Table 6-18
X	-36 (For 3950 MHz Percentile Criterion >2% Error at +25°C)	NDA	AVSI AFE 76s2 Report Vol III Table 8-14
U	NB (> -19.8) (For 4050 MHz NCD Criterion)	NB (> -19.8) (For 4150 MHz NCD Criterion)	AVSI AFE 76s2 Report Vol III Table 6-21

Radio Altimeter model	3.8-4.1 GHz	4.1-4.2 GHz	Source
Y	-37 (For 3930 MHz)	NDA	AVSI AFE 76s2 Report Vol I Table 3-1
<p>Note: NB (> VALUE) refers to “No Breakpoint”, meaning normal RA operation up to the maximum 5G signal level tested, where VALUE is the maximum power tested, and the breakpoint would be higher than this level. This tested power level should not be considered as a breakpoint.</p> <p>Note: The breakpoints are converted to dBm/MHz.</p> <p>Note: NDA refers to “no data available,” meaning testing was not conducted for the frequency range.</p> <p>Note: NCD refers to “no computed data”.</p> <p>Note: Model L was tested up to a frequency of 4.05 GHz. Model X was tested up to a frequency of 4.00 GHz. Model Y was tested up to a frequency of 3.98 GHz.</p> <p>Note: The breakpoints consider a percentile criterion of +/-2% error and an NCD criterion and do not consider a criterion of a mean error of 0.5%. The mean error deviation of 0.5% is more stringent than the Radio Altimeter height accuracy of +/-3%, across 95% of measured observations that is defined in RTCA DO-155 / EUROCAE ED-30.</p>			

4.3.2.3 Frequency band 4.2-4.4 GHz

Table 6: UC1 maximum interference levels between 4.2-4.4 GHz in dBm/MHz

Altimeter model	200 feet	1000 feet	Source
F	-67 (-22 dB for /MHz conv.)	-79 (-22 dB for /MHz conv.)	AVSI AFE 76s2 Vol II [2] Table 4-2
L	-79.0 or -75 with justification (Avg. value – 22 dB for /MHz conv.)	-79.9 or -75 with justification (Avg. value – 22 dB for /MHz conv.)	AVSI AFE 76s2 Vol III: Table 8-31
T	-60.8 (For >2% Error -20 dB for /MHz conv.)	-65.8 (For >2% Error -20 dB for /MHz conv.)	AVSI AFE 76s2 Vol III: Table 6-62
X	-61.1 or -57.8 with justification (Avg. value -22 dB for /MHz conv.)	-91.5 or -77.2 with justification (Avg. value -22 dB for /MHz conv.)	AVSI AFE 76s2 Vol III: Table 8-32
U	NB (>-19.8) (For NCD Criterion)	NB (>-19.8) (For NCD Criterion)	AVSI AFE 76s2 Vol III: Table 6-63
Y	-64 (-22 dB for /MHz conv.)	-78 (-22 dB for /MHz conv.)	AVSI AFE 76s2 Vol II: Table 4-2
<p>Note: Model X was tested at an height of 250 feet AGL rather than 200 feet AGL.</p> <p>Note: NB (> VALUE) refers to “No Breakpoint”, meaning normal RA operation up to the maximum 5G signal level tested, where VALUE is the maximum power tested, and the breakpoint would be higher than this level. This tested power level should not be considered as a breakpoint.</p> <p>Note: The breakpoints are converted to dBm/MHz.</p> <p>Note: NDA refers to “no data available,” meaning testing was not conducted for the frequency range.</p> <p>Note: NCD refers to “no computed data”.</p> <p>Note: Models X and L have thresholds corresponding to the average breakpoint tested. While the Manufacturer tests for these Radio Altimeters between 4.2 to 4.4 GHz in AVSI AFE 76s2 Report Volume III do not provide the worst-case but the average value and standard deviation, a 3sigma deviation may overestimate the ITT. Thus, it is proposed that the average value is used for these cases due to lack of information of the worst-case performance amongst the tested units. The manufacturer recommended using the average value minus three times the standard deviation for calculation of the ITT.</p>			

Altimeter model	200 feet	1000 feet	Source
Note: The breakpoints consider a percentile criterion of +/-2% error and an NCD criterion and do not consider a criterion of a mean error of 0.5%. The mean error deviation of 0.5% is more stringent than the Radio Altimeter height accuracy of +/-3%, across 95% of measured observations that is defined in RTCA DO-155 / EUROCAE ED-30.			

4.3.3 Breakpoint values (Parameter Set 2)

Parameter Set 2 considers the breakpoint values reported in AVSI AFE 76s2 Report Vol. I and Vol. III where all breakpoint measures, clearly reported in tables, are obtained through the same measurement setup for all RA models and can be compared. In AVSI AFE 76s2 Report Vol. III, measurements are performed by different manufacturers, each using different measurement setups that differ from the one defined in the first two reports, making them difficult (if not impossible) to compare.

The breakpoint values reported in Table 7 correspond to the breakpoint values of the most sensitive Radio Altimeter for a given band and height, taken from Table 3-1 of AVSI AFE 76s2 Report Vol I and Table 4-2 of AVSI AFE 76s2 Report Vol II. In the AVSI AFE 76s2 Report Volumes I and II, breakpoint values are reported in dBm, so 20 dB (100 MHz bandwidth measured at 3.4-4.2 GHz) or 22 dB (160 MHz bandwidth measured at 4.2-4.4 GHz) was subtracted to convert to dBm/MHz.

It should be noted that, for the frequency band 4.1-4.2 GHz band, no breakpoint data is available in AVSI AFE 76s2 Reports Vol. I and II. In AVSI AFE 76s2 Report Vol. III, breakpoint values are only available for model F and T, which is not representative of all RA models. In addition, model F is more resilient in the 4.1-4.2 GHz frequency band than in 3.8-4.1 GHz frequency band, which is a strange behaviour as it is closer to the RA operating band. It is not guaranteed that other models follow the same behaviour. Therefore, in the absence of clear information, Parameter Set 2 assumes that the breakpoint values obtained in the 3.8-4.1 GHz frequency band also apply for the 4.1-4.2 GHz frequency band.

The use of the 0.5% mean error is considered in parameter set 2 as one of the three criteria proposed by aviation experts to be taken into account to define the breakpoint. This criteria, in particular, is used in MOPS DO-155 [25]/ED-30 [26] to require that the root mean square (RMS) noise shall be less than 0.5% of the true height.

Table 7: Breakpoint values for Parameter Set 2, in dBm/MHz, at two different heights

Frequency band (GHz)	Height: 200 feet	Height: 1000 feet	Source
3.4-3.8	-33	-40	AVSI AFE 76S2 Report Vol I; Table 3-1, Altimeter F @3750 MHz
3.8-4.1	-36	-44	AVSI AFE 76S2 Report Vol I; Table 3-1, Altimeter F @3930 MHz
4.1-4.2	-36	-44	
4.2-4.4	-74	-79	AVSI AFE 76s2 Report Vol II Table 4-2, 200 feet: Altimeter L, 1000 feet: Altimeter F.

Note: The breakpoint power at 3.75 GHz is assumed to be constant down to 3.40 GHz.

4.3.4 Radio Altimeter antenna assumptions

4.3.4.1 For Parameter Set 1

The antenna for the in-band case (4.2-4.4 GHz) is modelled using Report ITU-R M.2319 with peak gain and 3 dB beam width based on RTCA Paper No. 274-20/PMC-2073 [25]. For the out-of-band/adjacent channels, the same antenna pattern is used, see Table 9.

Table 8: Antenna parameters for Radio Altimeter Parameter Set 1

Frequency range	Peak gain,	3 dB beam width	Cable loss	Pattern
3.4-4.1 GHz	0 dBi, 60°	60°	3 dB	Report ITU-R M.2319, equation A-3.6
4.1-4.2 GHz	6 dBi, 60°	60°	3 dB	
4.2-4.4 GHz	9 dBi, 60°	60°	3 dB	

4.3.4.2 For Parameter Set 2

The parameters for the radio altimeter antenna in parameter set 2 are provided in Table 9.

Table 9: Antenna parameters for Radio Altimeter Parameter Set 2

Frequency Range (GHz)	3.4-3.8	3.8-4.1	4.1-4.2	4.2-4.4
Antenna Gain (dBi)	0	3	8	10
Antenna pattern	Omni incl. cable loss	Omni incl. cable loss	Report ITU-R M.2319, equation A-3.6 with 3 dB beam width of 60°) and 3 dB cable loss	Report ITU-R M.2319, equation A-3.6 with 3 dB beam width of 60°) and 3 dB cable loss

The values in Table 9 are based on the following assumptions:

- For the in-band (4.2-4.4 GHz) the Radio Altimeter antenna pattern can be described using Report ITU-R M.2319 with 10 dBi antenna peak gain and 3 dB beam width of 60° ;
- Cable loss of 3 dB is to be added in the sharing and compatibility studies;
- Pitch and roll may be considered.

For the out-of-band (3.4-4.2 GHz) the Radio Altimeter antenna information is less accurate, and the following assumptions are taken:

- For 4.1-4.2 GHz the Radio Altimeter is within the roll off region between in-block and out-of-band with using Report ITU-R M.2319 with 8 dBi antenna peak gain and 3 dB beam width of 60°. Cable loss of 3 dB is to be added in the sharing and compatibility studies. Pitch and roll may be considered;
- For 3.8-4.1 GHz the Radio Altimeter antenna pattern is approximated using omni-directional gain with 3 dBi. The cable loss is included in the gain of the antenna;
- For 3.4-3.8 GHz the Radio Altimeter antenna pattern is approximated using omni-directional gain with 0 dBi. The cable loss is included in the gain of the antenna.

5 DESCRIPTION OF INTERFERENCE SCENARIOS

5.1 AIRCRAFT LANDING SCENARIO

The aircraft glide slope will determine the location of the aircraft when approaching the landing runway. Most studies considered a typical glide slope angle used by the Instrument Landing System (ILS) with flat terrain and under nominal conditions.

An ILS is a precision runway approach aid employing two radio beams to provide pilots with vertical and horizontal guidance during the landing approach. The localiser provides azimuth guidance, while the glide slope defines the correct vertical descent profile. This glide slope is usually 3° with a tolerance of $\pm 0.375^\circ$. Thus, a glide slope of 2.625° corresponds to the lowest nominal aircraft trajectory which can lead to reduced distances between BS and aircraft when assessing the interference, depending on the nominal BS height, the OLS and the baseline breakpoint height.

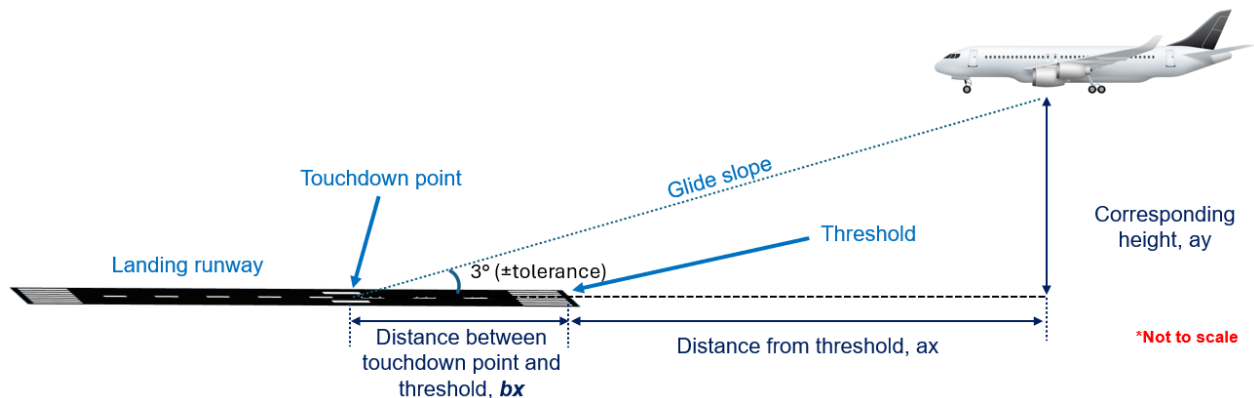

Figure 6: Aircraft landing scenario

In addition, the distance between the touchdown point and the threshold (i.e. the variable b_x in Figure 6) that is considered in the different studies varies (e.g. 0 m, 380 m, etc.). The 'touchdown point' terminology used in this Report refers to the point of intersection between the runway and the glide slope. Page 5-12 of the ICAO Annex 14 [28] shows an example of touchdown aiming point markings at 400 m from the threshold for a 2400 m runway length and some studies consider a worst-case situation where the aircraft touchdown point is on the threshold.

5.2 OBSTACLE LIMITATION SURFACE

The OLS Obstacle Limitation Surface (OLS) is a surface above the area surrounding a runway which no 'obstacles' should penetrate. This is to protect the transition of the aircraft to and from the runway.

The ICAO Annex 14 to the Convention on International Civil Aviation in the International Standards and Recommended Practices (ISRP) Volume I describes the OLS around aerodromes which includes the airspace above the approach surface, transitional surfaces, balked landing surface, etc. These conceptual (imaginary) surfaces are not to be penetrated by any fixed obstacle. However, it should be noted, that most airports present their own obstacle limitation surfaces exception that could be more or less stringent.

Figure 7 and Figure 8 show the OLS from the view at the side of the runway and from the view of the approaching aircraft. These figures also include the relevant slope angles as it was used in the studies.

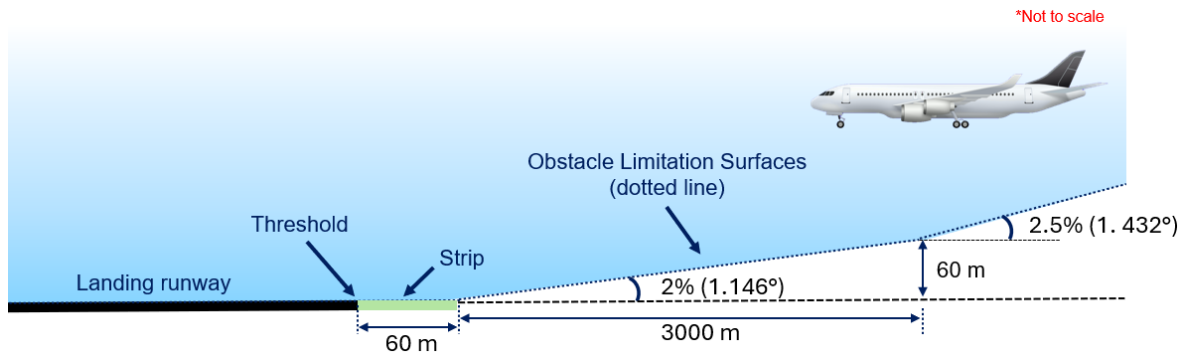

Figure 7: The Obstacle Limitation Surface for the landing approach

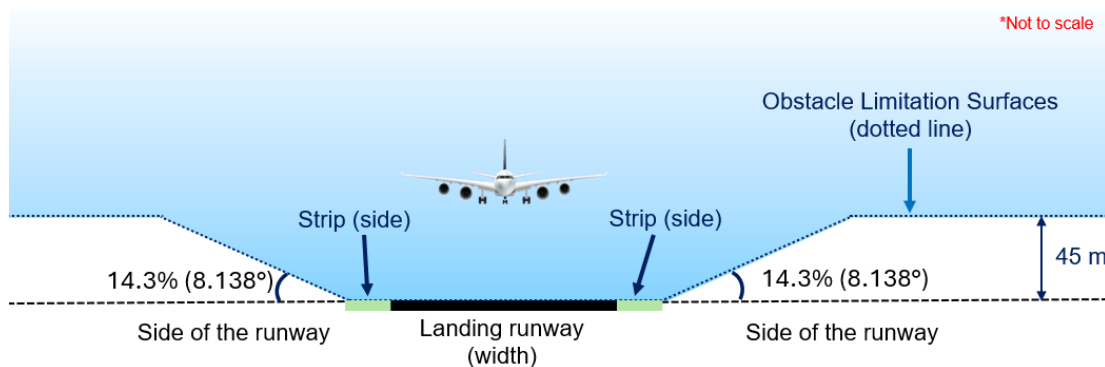

Figure 8: The Obstacle Limitation Surface at both sides of the runway

Figure 9 shows the relevant parameters that are required when defining the interference scenario. The distance from the runway threshold to the point where the OLS approach surface starts (marked as cx) could be set to 60 m while one half of the width of the runway (marked as az) could be set to 140 m.

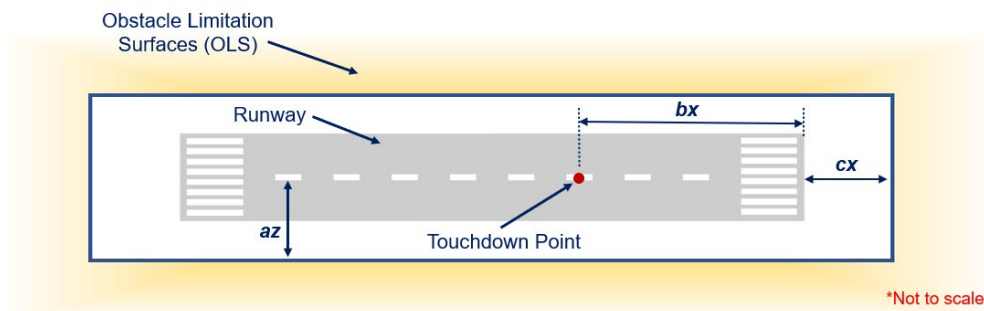

Figure 9: The runway safety area

It should be noted that the aircraft touchdown point on the runway is different among the studies, consequently evaluating scenarios with different distance between the touchdown point and the start of the OLS. It is also worth noting that the result of some studies is not affected by the individual values of bx and cx as long as the sum of these distances (i.e. $bx + cx$) are the same.

5.3 SCENARIOS

The studies generally take account of the OLS where the base stations are located under this surface. Some studies also evaluate interference contours around the aircraft where OLS are not used. The scenario also takes account of the nominal trajectory of the aircraft described in the landing scenario (see section 5.1) and the base stations are oriented (in azimuth) towards the aircraft to evaluate the highest possible power level from these base stations.

6 CONCLUSIONS

6.1 HIGH-LEVEL SUMMARY

This ECC Report studies the compatibility of Radio Altimeters operating in the 4200-4400 MHz band with public 5G mobile networks operating in the 3400-3800 MHz band, referred to as mobile or fixed communications networks (MFCN), as well as with local and private 5G networks using low and medium power base stations in the 3800-4200 MHz band, referred to as wireless broadband systems low/medium power (WBB LMP).

The Radio Altimeter parameters used in this ECC Report are based on measurements for several Radio Altimeter models, with Interference Tolerance Thresholds (ITT) derived from published AVSI Reports⁹ for heights of 200 feet and 1000 feet. The interference tolerance threshold values of the various Radio Altimeter models differ by several magnitudes. It is relevant to note that only usage category 1 (UC1) Radio Altimeters have been considered as that category is “used in a wider variety of safety-critical systems that enable safe operation of commercial airliners in all-weather conditions” (as stated in AVSI Report Vol. I).

The 5G technical parameters are derived from existing ECC Reports, ECC Decisions, ETSI standards and ITU-R documentation. The studies consider two different base station antenna types: Active Antenna Systems (AAS), which include electronic beamforming features, and more conventional non-AAS antennas with wider static beams covering the cell. The baseline assumptions for the base stations are found in Annex 1 of the ECC Report and include an assumption that AAS base station transmissions will be pointing at or below horizon (‘beamforming’) as typical or normal operation.

Different studies used different Radio Altimeter parameters described as Parameter Sets 1 and 2 within this ECC Report, that were based on information provided to CEPT:

- Parameter Set 1 contains data on a variety of Radio Altimeter models primarily derived from AVSI Report Volume III;
- Parameter Set 2 contains data based on AVSI Report Volume I and Volume II, for the least resilient Radio Altimeter model.

Both Parameter Sets also use different assumptions for the Radio Altimeter antenna. Section 5 of this ECC Report provides further details on these and other factors.

The main scenario was modelled as a nominal Instrument Landing System (ILS) approach with associated Obstacle Limitation Surface (OLS), as defined by the International Civil Aviation Organization (ICAO). These are described in section 5.

Two phenomena have been studied in this Report:

- The effect of unwanted emissions from WBB-LMP or MFCN in the adjacent bands falling in the 4200–4400 MHz band used by Radio Altimeters;
- The effect of blocking. Blocking is where a Radio Altimeter’s receiver performance is reduced by strong radiofrequency (RF) emissions from MFCN or WBB-LMP in the adjacent frequency bands.

A 6 dB safety margin, as recommended by ICAO, is taken into account in the conclusion of all studies.

Based on the above Radio Altimeter parameters, as well as typical base station parameters and set up, this ECC Report derives the following conclusions for the modelled ILS approach scenario:

For MFCN (5G) operating in frequency band 3400-3800 MHz

In summary, the results show:

- All studies of unwanted emissions, falling into the Radio Altimeter band from 5G MFCN operating in the 3400-3800 MHz frequency band, show sufficient margins covering at least the 6 dB ICAO safety margin;
- Studies of potential blocking of the Radio Altimeter receiver using Parameter Set 1 and associated antenna radiation patterns (including a roll angle of up to ± 15 degrees) and with MFCN 5G AAS base station main

⁹ Aerospace Vehicle Systems Institute (AVSI) is an aerospace industry research cooperative that facilitates collaborative research and technology projects for its members. The referenced reports can be found at <https://avsi.aero>

beam pointing at or below the horizon show sufficient margins covering at least the 6 dB ICAO safety margin;

- Some studies of blocking using Parameter Set 2 have also extended parameters of the Radio Altimeter to heights other than 200 feet and 1000 feet. The outcome of these studies leads to some base station locations where the interference tolerance threshold at the Radio Altimeter is exceeded. A study proposes an approach in this Report in order to manage the risk of interference.

For Wireless Broadband Low-Medium Power (WBB LMP) operating in 3800-4200 MHz

For the frequency band 3.8-4.1 GHz, all studies show sufficient margins covering at least the 6 dB safety margin as recommended by International Civil Aviation Organization (ICAO).

For the frequency band 4.1-4.2 GHz, all studies show sufficient margins covering at least the 6 dB ICAO safety margin, except for some types of medium power beamforming base station and radio altimeter scenarios (below 200 feet) where:

- Studies using Parameter Set 1 or Parameter Set 2 at 200 feet and 1000 feet show sufficient margins covering at least the 6 dB ICAO safety margin;
- However, a study using Parameter Set 2, which applies the 200 feet interference tolerance threshold below 200 feet, shows that unwanted emissions from these base stations do not meet the 6 dB ICAO safety margin for the modelled beamforming antenna configurations. The same study shows the 6 dB ICAO safety margin is fully covered for base station's positions greater than 1200 m from the runway threshold or 40 m laterally or with some improved out-of-band emission levels (further details are provided in Annex 3 of the ECC Report).

There are a number of differences between the results for Parameter Set 1 and Parameter Set 2. However, all studies found that lower heights are more critical than the Radio Altimeter at 1000 feet when considering potential interference. In addition, results are particularly sensitive to the assumptions for the Radio Altimeter antenna patterns particularly at high off-axis angles for low heights (below 200 feet).

Some administrations have also performed measurement campaigns, the results of which are provided for information in the Attachment to this ECC Report "Field measurement campaigns from some administrations related to MFCN in 3400-3800 MHz and Radio Altimeters in 4200-4400 MHz". The outcome of these campaigns finds no interference from MFCN transmissions to the Radio Altimeters, scenarios and aircraft tested.

6.2 TECHNICAL SUMMARY

The studies in this ECC Report are based on measurements for several Radio Altimeter (RA) models, with Interference Tolerance Thresholds (ITT) derived from published AVSI Reports [1] - [3]¹⁰. The ITT of the various Radio Altimeter models differ by many dB. Only usage category 1 (UC1) Radio Altimeters have been considered as that category is "used in a wider variety of safety-critical systems that enable safe operation of commercial airliners in all-weather conditions" (as stated in AVSI Report Vol. I).

The analysis in this Report is complex and relies on many different technical parameters.

There was difficulty in reaching unanimous agreement on the Radio Altimeter parameters. Therefore, different studies used some different Radio Altimeter parameters which are described as Parameter Set 1 and 2 with ITT values for 200 and 1000 feet within this Report as the baseline, that were based on information provided to CEPT. Parameter Set 1 contains data on a variety of Radio Altimeter models primarily derived from AVSI Report Volume III. Parameter Set 2 contains data for the least resilient Radio Altimeter model based on AVSI Report Volume I and Volume II. Both Parameter Sets use different assumptions for the Radio Altimeter antenna. Section 5 provides further details on these and other factors.

¹⁰ Aerospace Vehicle Systems Institute (AVSI) is an aerospace industry research cooperative that facilitates collaborative research and technology projects for its members. The referenced reports can be found at <https://avsi.aero>

Differences in the radio altimeter parameters between Parameter Set 1 and Parameter Set 2 (see section 4.3) and differences in the modelled scenarios result in a range of conclusions. Annex 1 contains the MFCN parameters used, and section 5 explains the high-level modelling scenario used.

The main scenario was modelled as a nominal Instrument Landing System (ILS) approach with associated Obstacle Limitation Surface (OLS).

Based on the above Radio Altimeter parameters, as well as typical Base Station parameters with antenna main beams pointing at or below the horizon, this Report derives the following conclusions for the modelled ILS approach scenario:

For MFCN operating in frequency band 3400-3800 MHz and Radio Altimeters in 4200-4400 MHz

In summary, the results show:

- All studies of spurious emissions (see ERC Recommendation 74-01 [4]) falling into the 4200-4400 MHz from MFCN operating in the 3400-3800 MHz frequency band show sufficient margins covering at least the 6 dB ICAO safety margin;
- Studies of potential blocking of the Radio Altimeter receiver:
 - using parameters and assumptions from Parameter Set 1 of ITT and RA antenna radiation patterns, (incl. roll up to ± 15 degrees), for macro MFCN BS operating in the 3400-3800 MHz frequency band with main beam pointing at or below the horizon (baseline assumptions), show sufficient margins covering at least the 6 dB ICAO safety margin;
 - using the ITT and Radio Altimeters antenna radiation patterns Parameter Set 2 of ITT and RA antenna radiation patterns, and where MFCN parameters deviate from Annex 1 (sensitivity analysis - e.g. 0° mechanical downtilt), there are some situations where the ITT at the Radio Altimeter is exceeded¹¹;
 - extending Parameter Set 2 (e.g. applying the 200 feet ITT values below 200 feet) and where MFCN parameters deviate from Annex 1 (sensitivity analysis - e.g. extended electrical steering range beyond typical setup, etc.), there are additional situations where the ITT at the Radio Altimeter is exceeded^{Error!}
Bookmark not defined.

The difference in the results is primarily due to:

- the ITT values of the two Parameter Sets, which differ in the critical case by 4 dB at 200 feet;
- the difference between RA antenna pattern of Parameter Set 1 and Parameter Set 2, particularly at high off-axis angles for low heights (below 200 feet).

When comparing all the results of the 3400-3800 MHz blocking studies, in general the results are most sensitive to the following assumptions:

- The modelling of the antenna patterns for the Radio Altimeter and the pitch and roll assumptions in Parameter Sets 1 and 2;
- The breakpoint/ITT values assumed below 200 feet;
- Base Station parameters (in-block power levels, boresight direction, mechanical downtilt and vertical coverage range);
- BS location relative to RA position (OLS, terrain profile along the approach, BS height, glide slope, touchdown point);
- Variance of the Radio Altimeter ITT values for different RA models (in the order of 30 dB) with no or significantly less risk of interference for those more resilient models.

The measurement results contained in the Attachment to this ECC Report "Field measurement campaigns from some administrations related to MFCN in 3400-3800 MHz and Radio Altimeters in 4200-4400 MHz" for additional information, show no interference from MFCN to the Radio Altimeters, scenarios and aircraft tested.

For Wireless Broadband Low-Medium Power (WBB LMP) operating in 3800-4200 MHz (based on 3GPP and DECT-2020 NR) and Radio Altimeters in 4200-4400 MHz.

¹¹ One administration has provided an example of its current national coordination measures to manage the risk of interference to RA (see Annex 3). Two other administrations have also implemented national measures while other administrations have not seen the need for national measures and therefore did not contribute on other possible mitigation measures.

For the frequency band 3800-4100 MHz:

- All studies show sufficient margins for unwanted emissions and Radio Altimeter blocking covering at least the 6 dB ICAO safety margin as recommended by International Civil Aviation Organization (ICAO);

For the frequency band 4100-4200 MHz:

- For non-AAS WBB LMP base stations, all studies show sufficient margins for unwanted emissions and Radio Altimeter blocking covering at least the 6 dB ICAO safety margin
- For AAS WBB LMP base stations:
 - the 6 dB ICAO safety margin is always met when considering Radio Altimeter Blocking (WBB LMP AAS in-band emissions);
 - Studies of Radio Altimeter protection at 200 and 1000 feet (baseline) show sufficient margins for unwanted emissions and Radio Altimeter blocking covering at least the 6 dB ICAO safety margin;

A study which applies the 200 feet ITT values below 200 feet (sensitivity analysis) shows that for unwanted emissions from WBB LMP falling in the 4200-4400 MHz band, base stations that were modelled with 4x4 and 8x8 AAS (non-sub-array) configurations close to the runway threshold can lead to situations where the 6 dB ICAO safety margin is not met by 13 dB (assuming the Block Edge Mask derived from ETSI TS 138 104 [47]). The same study shows the 6 dB ICAO safety margin is fully covered for BS positions greater than 1200 m from the runway threshold or 40 m laterally, or at all BS positions with emission levels, between 4200-4240 MHz, equal to the spurious emission limit. Details are provided in Annex 3.

ANNEX 1: ITU-R IMT DEPLOYMENT PARAMETERS AND AAS MODEL FOR SHARING AND COMPATIBILITY STUDIES

Table 10 and Table 11 are based on Working Party 5D Chairman's Report, "Characteristics of terrestrial component of IMT for sharing and compatibility studies in preparation for WRC-23", Annex 4.4 to Document 5D/716-E [27].

The power level of *e.i.r.p.* for 3.4-3.8 GHz macro Active Antenna System (AAS) Base Stations used in some studies is 78 dBm/100 MHz while in some studies it is 82 dBm/100 MHz, where both power levels uses the antenna configuration in Table 12 by adjusting the total conducted power accordingly.

Table 10: Deployment-related parameters for bands between 3 and 6 GHz

	Rural (optional, see Note)	Urban/suburban macro	Urban small cell (outdoor)/Micro cell	Indoor (small cell)
Base station characteristics/Cell structure				
Cell radius / Deployment density (non-AAS)	1.2 km / isolated BSs or a cluster of four BSs with the density of 0.001-0.006 BSs/km ² (Note 2)	Typical cell radius 0.3 km urban / 0.6 km suburban	1-3 per urban macro cell <1 per suburban macro site	Depending on indoor coverage/ capacity demand
Cell radius / Deployment density (AAS)	1.6 km / isolated BSs or a cluster of four BSs with the density of 0.001-0.006 BSs/km ² (Note 2)	Typical cell radius 0.4 km urban / 0.8 km suburban (10 BSs/km ² urban / 2.4 BSs/km ² suburban (Note 2))	1-3 per urban macro cell <1 per suburban macro site	Depending on indoor coverage/ capacity demand
Antenna height	35 m	20 m urban / 25 m suburban	6 m	3 m
Sectorisation	3 sectors	3 sectors	Single sector	Single sector
Non-AAS BS Downtilt (Note 1)	3 degrees	10 degrees urban / 6 degrees suburban	N/A	N/A
Frequency reuse	1	1	1	1
Non-AAS BS antenna pattern (Note 1)	Recommendation ITU- R F.1336 (recommends 3.1) [28] ka = 0.7 kp = 0.7 kh = 0.7 kv = 0.3 Horizontal 3 dB beamwidth: 65 degrees Vertical 3 dB beamwidth: determined from the horizontal beamwidth by equations in Recommendation ITU- R F.1336. Vertical beamwidths of actual antennas may also be used when available.	Recommendation ITU- R F.1336 (recommends 3.1) [28] ka = 0.7 kp = 0.7 kh = 0.7 kv = 0.3 Horizontal 3 dB beamwidth: 65 degrees Vertical 3 dB beamwidth: determined from the horizontal beamwidth by equations in Recommendation ITU- R F.1336. Vertical beamwidths of actual antennas may also be used when available.	Recommendation ITU-R F.1336 (omni: recommends 2) [28]	
Antenna polarisation	Linear/±45 degrees	Linear/±45 degrees	Linear	Linear

	Rural (optional, see Note)	Urban/suburban macro	Urban small cell (outdoor)/Micro cell	Indoor (small cell)
Indoor base station deployment	N/A	N/A	N/A	100%
Indoor base station penetration loss	N/A	N/A	N/A	Recommendation ITU-R P.2109 [32]
Below rooftop base station antenna deployment (Report ITU-R M.2292 [31]) (Note 1)	0%	Urban: 50% Suburban: 0%	100%	N/A
Non-AAS BS Feeder loss (Note 1)	3 dB	3 dB	N/A	N/A
Typical channel bandwidth	40 or 80 or 100 MHz	40 or 80 or 100 MHz	40 or 80 or 100 MHz	40 or 80 or 100 MHz
Maximum Non-AAS BS output power (Note 1)	52 dBm in 40 MHz 55 dBm in 80 MHz 56 dBm 100 MHz	49 dBm in 40 MHz 52 dBm in 80 MHz 53 dBm in 100 MHz	24 dBm in 40 or 80 or 100 MHz	24 dBm in 40 or 80 or 100 MHz
Maximum base station non-AAS antenna gain (Note 1)	18 dBi	18 dBi	5 dBi	0 dBi
Maximum base station output power/sector (e.i.r.p.) (non-AAS BS) (Note 1)	67 dBm in 40 MHz 70 dBm in 80 MHz 71 dBm in 100 MHz	64 dBm in 40 MHz 67 dBm in 80 MHz 68 dBm in 100 MHz	29 dBm in 40 or 80 or 100 MHz	24 dBm in 40 or 80 or 100 MHz
Network loading factor (base station load probability X%) (see section 3.4 (<i>ibidem</i>) below and Rec. ITU-R M.2101 Annex 1, section 3.4.1 and 6 [33])	20%, 50%	20%, 50%	20%, 50%	20%, 50%
Average base station power/sector (e.i.r.p.) (non-AAS BS) taking into account activity factor (Note 1)	Use Recommendation ITU-R M.2101 [33]	Use Recommendation ITU-R M.2101 [33]	Use Recommendation ITU-R M.2101 [33]	Use Recommendation ITU-R M.2101 [33]
TDD / FDD	TDD	TDD	TDD	TDD
BS TDD activity factor	75%	75%	75%	75%
<p>Note: For the 3-6 GHz range, contiguous coverage is not expected in this frequency range in rural areas, and any such base stations that may exist in small numbers will be isolated installations at specific locations, and therefore, the rural deployment environment may or may not be included in the sharing and compatibility studies, depending on the area of study.</p> <p>Note 1: This parameter is only applicable for non-AAS base stations. Antenna characteristics for AAS base stations (for frequency bands above 1710 MHz) are provided in Table 12.</p> <p>Note 2: "1 BS" = 1 sector in 3-sector cell.</p>				

Table 11: UE parameters for bands between 3 and 6 GHz

	Rural (optional, see Note A above)	Urban/suburban macro	Urban small cell (outdoor)/Micro cell	Indoor (small cell)
User terminal characteristics				
Indoor user terminal usage (Report ITU-R M.2292)	50%	70%	70%	100%
Indoor user terminal penetration loss	Recommendation ITU-R P.2109 [32] (traditional building)	Recommendation ITU-R P.2109 [33]	Recommendation ITU-R P.2109 [33]	Recommendation ITU-R P.2109 [32]
User equipment density for terminals that are transmitting simultaneously (Note 1)	3 UEs per BS	3 UEs per BS	3 UEs per BS	3 UEs per BS
UE height (Note 2)	Outdoor: 1.5 m	Outdoor:1.5 m	Outdoor:1.5 m	1.5 m
Average user terminal output power	Use transmit power control	Use transmit power control	Use transmit power control	Use transmit power control
Typical antenna gain for user terminals	-4 dBi	-4 dBi	-4 dBi	-4 dBi
Body loss	4 dB	4 dB	4 dB	4 dB
UE TDD activity factor	25%	25%	25%	25%
Transmit power control				
Power control model	Refer to Recommendation ITU-R M.2101 [33]			
Maximum user terminal output power, PCMAX	23 dBm	23 dBm	23 dBm	23 dBm
Transmit power (dBm) target value per RB, P0_PUSCH (Note 3)	-92.2	-92.2	-87.2	-87.2
Path loss compensation factor, α (same as "balancing factor" mentioned in Recommendation ITU-R M.2101 [33])	0.8	0.8	0.8	0.8
<p>Note: For the 3-6 GHz range, contiguous coverage is not expected in this frequency range in rural areas, and any such base stations that may exist in small numbers will be isolated installations at specific locations, and therefore, the rural deployment environment may or may not be included in the sharing and compatibility studies, depending on the area of study.</p> <p>Note 1: UEs share equally the channel bandwidth, i.e. each UE is allocated 1/3 of the channel bandwidth (see Recommendation ITU-R M.2101, section 3.4.1, item 1e-f. [33]). In sharing studies, it is assumed that the AAS BS beamforms towards each UE using the entire array.</p> <p>Note 2: In principle, indoor UEs are distributed over different floors of the building. It should be noted that the number of floors of buildings vary within the environment and among the countries. Moreover, the number of floors of buildings is not related to Macro BS antenna height (parameter given in the Table). In particular in small cities, sub-urban and rural areas, many or most of antennas are installed on masts. Therefore, for outdoor BSs, indoor UEs are assumed to be modelled on the ground floor for the sharing study.</p> <p>Note 3: The target power is defined per Resource Block (RB), considering 180 kHz RB bandwidth corresponding to 15 kHz subcarrier spacing.</p>				

Table 12: Beamforming antenna characteristics for IMT in 1710-4990 MHz

		Rural macro	Suburban macro	Urban macro	Urban small cell (outdoor)/Micro cell	Indoor (small cell)
1	Base station antenna characteristics					
1.1	Antenna pattern	Refer to the extended AAS model in Table 13			Refer to section 5 of Recommendation ITU-R M.2101 [33]	N/A
1.2	Element gain (dBi) (Note 1)	6.4	6.4	6.4	6.4	N/A
1.3	Horizontal/vertical 3 dB beam width of single element (degree)	90° for H 65° for V	90° for H 65° for V	90° for H 65° for V	90° for H 65° for V	N/A
1.4	Horizontal/vertical front-to-back ratio (dB)	30 for both H/V	30 for both H/V	30 for both H/V	30 for both H/V	N/A
1.5	Antenna polarisation	Linear $\pm 45^\circ$	Linear $\pm 45^\circ$	Linear $\pm 45^\circ$	Linear $\pm 45^\circ$	N/A
1.6	Antenna array configuration (Row \times Column) (Note 2)	4 \times 8 elements	4 \times 8 elements	4 \times 8 elements	8 \times 8 elements	N/A
1.7	Horizontal/Vertical radiating element/sub-array spacing, d_h / d_v	0.5 of wavelength for H, 2.1 of wavelength for V	0.5 of wavelength for H, 2.1 of wavelength for V	0.5 of wavelength for H, 2.1 of wavelength for V	0.5 of wavelength for H, 0.7 of wavelength for V	N/A
1.7a	Number of element rows in sub-array, M_{sub}	3	3	3	N/A	N/A
1.7b	Vertical radiating element spacing in sub-array, $d_{v,sub}$	0.7 of wavelength of V	0.7 of wavelength of V	0.7 of wavelength of V	N/A	N/A
1.7c	Pre-set sub-array down-tilt, $\theta_{subtilt}$ (degrees)	3	3	3	N/A	N/A
1.8	Array Ohmic loss (dB) (Note 1)	2	2	2	2	N/A
1.9	Conducted power (before Ohmic loss) per antenna element/sub-array (dBm) (Note 5, 6)	28	28	28	16	N/A
1.10	Base station horizontal coverage range (degrees)	± 60	± 60	± 60	± 60	N/A
1.11	Base station vertical coverage range (degrees) (Notes 3, 4, 7)	90-100	90-100	90-100	90-120	N/A
1.12	Mechanical downtilt (degrees) (Note 4)	3	6	6	10	N/A
1.13	Maximum base station output power/sector (e.i.r.p.) (dBm)	72.28	72.28	72.28	61.53	N/A

	Rural macro	Suburban macro	Urban macro	Urban small cell (outdoor)/Micro cell	Indoor (small cell)
<p>Note 1: The element gain in row 1.2 includes the loss given in row 1.8 and is per polarisation. This means that this parameter in row 1.8 is not needed for the calculation of the BS composite antenna gain and <i>e.i.r.p.</i></p> <p>Note 2: For the small/micro cell case, 8 × 8 means there are 8 vertical and 8 horizontal radiating elements. For the extended AAS model case, 4 × 8 means there are 4 vertical and 8 horizontal radiating sub-arrays.</p> <p>Note 3: The vertical coverage range is given in global coordinate system, i.e. 90° being at the horizon.</p> <p>Note 4: The vertical coverage range in row 1.11 includes the mechanical downtilt given in row 1.12.</p> <p>Note 5: The conducted power per element assumes 8 × 8 × 2 elements for the micro/small cell case, and 4 × 8 × 2 sub-arrays for the macro case (i.e. power per H/V polarized element).</p> <p>Note 6: In sharing studies, the transmit power calculated using row 1.9 is applied to the typical channel bandwidth given in Table 10 respectively for the corresponding frequency bands.</p> <p>Note 7: In sharing studies, the UEs that are below the base station vertical coverage range can be considered to be served by the “lower” bound of the electrical beam, i.e. beam steered towards the max. coverage angle. A minimum BS-UE distance along the ground of 35 m should be used for urban/suburban and rural macro environments, 5 m for micro/outdoor small cell, and 2 m for indoor small cell/urban scenarios.</p>					

Table 13: Extended AAS model

Description	Equation
Peak normalised element radiation pattern	$A(\theta, \varphi) = -\min \left[-\left(-\min \left[12 \left(\frac{\varphi}{\varphi_{3dB}} \right)^2, A_m \right] - \min \left[12 \left(\frac{\theta - 90}{\theta_{3dB}} \right)^2, SLA_v \right] \right), A_m \right]$
Peak gain normalised element radiation pattern	$A_E(\theta, \varphi) = G_{E,max} + A(\theta, \varphi)$
Sub-array excitation	$w_m = \frac{1}{\sqrt{M_{sub}}} \exp \left(j2\pi(m-1) \frac{d_{v,sub}}{\lambda} \sin(\theta_{subtilt}) \right)$
Sub-array radiation pattern	$A_{sub}(\theta, \varphi) = A_E(\theta, \varphi) + 10 \log_{10} \left(\left \sum_{m=1}^{M_{sub}} w_m v_m \right ^2 \right)$ <p>where</p> $v_m = \exp \left(j2\pi(m-1) \frac{d_{v,sub}}{\lambda} \cos(\theta) \right)$
Array excitation	$w_{m,n} = \frac{1}{\sqrt{MN}} \exp \left(j2\pi \left((m-1) \frac{d_v}{\lambda} \sin(\theta_{etilt}) - (n-1) \frac{d_h}{\lambda} \cos(\theta_{etilt}) \sin(\varphi_{escan}) \right) \right)$ <p>Where M and N is corresponding to (Row × Column) in Table 12, row 1.6.</p>
Composite array radiation pattern	$A_A(\theta, \varphi) = A_{sub}(\theta, \varphi) + 10 \log_{10} \left(\left \sum_{m=1}^M \sum_{n=1}^N w_{m,n} v_{m,n} \right ^2 \right)$ <p>where</p> $v_{m,n} = \exp \left(j2\pi \left((m-1) \frac{d_v}{\lambda} \cos(\theta) + (n-1) \frac{d_h}{\lambda} \sin(\theta) \sin(\varphi) \right) \right)$ <p>Where M and N is corresponding to (Row × Column) in Table 12, row 1.6.</p>

	Susceptibility level (dBm/100 MHz)												
100 feet	-1	-1	-2	-0.5	-1	-1	-1	-3.4	-12	-15.5	-15	-13	-13
200 feet	-4.5	-6.5	-7.5	-7.5	-6.5	-1	-1	-6	-16	-18.5	-21	-17	-17
1000 feet	-1	-4	-5.5	-2	-1	-1	-1	-10	-20	-24.5	-26	-22.5	-22
5000 feet	-1	-2	-3	-1.5	-1	-1	-3.5	-18.5	-27.5	-31	-34	-30	-29

Finally, in addition to these values, the additional ICAO 6 dB margin should be considered for safety reasons. The following values represents the susceptibility in dBm of the RA receiver to be considered to ensure appropriate protection of the system.

Table 16: Susceptibility level for Radio Altimeter Model F with worst-case sample and ICAO safety margin

	Susceptibility level (dBm/100 MHz)												
Heights	Frequency (GHz)												
	3	3.1	3.2	3.3	3.4	3.5	3.6	3.7	3.8	3.9	4.0	4.1	4.2
100 feet	-7	-7	-8.5	-6.5	-7	-7	-7	-9.4	-18	-21.5	-21	-19	-19
200 feet	-10.5	-12.5	-13.5	-13.5	-12.5	-7	-7	-12	-22	-24.5	-27	-23	-23
1000 feet	-7	-10	-11.5	-8	-7	-7	-7	-16	-26	-30.5	-32	-28.5	-28
5000 feet	-7	-8	-9	-7.5	-7	-7	-9.5	-24.5	-33.5	-37	-40	-36	-35

A2.3 CALCULATION OF REQUIRED SEPARATION DISTANCE

The MCL calculations are summarised in Table 17.

Table 17: MCL calculation

	3400-3800 MHz	4200-4400 MHz	Note
UE Tx Power (dBm)	23		
UE spurious emissions (dBm/MHz)		-30	
UE Antenna gain (dB)	-3	-3	ECC Report 309 [44]
Pathloss attenuation (dB) at D=51 m	78.2	78.9	Free Space propagation model
Pathloss attenuation (dB) at D=100 m	84.0	84.9	Free Space propagation model
Pathloss attenuation (dB) at D=500 m	98.0	98.9	Free Space propagation model
RA antenna gain (dBi)	11	11	
RA Feeder Loss (dB)	6	6	
Signal level at D=51 m	-53.2	-106.9	
Signal level at D=100 m	-59.0	-112.9	
Signal level at D=500 m	-73.0	-126.9	

The calculation results in Table 17 show that at 51 m separation distance, the out of band signal level at RA receiver input is -53.2 dBm within a bandwidth an aerial UE is transmitting. A high data payload UE can occupy up to 5 MHz when it transmits a 5 Mbps data rate. The worst blocking level in the band 3400-3800 MHz is given as -33.5 dBm/100 MHz at 5000 feet, which is about -46.5 dBm/5 MHz. This shows there is no risk of blocking from the aerial UE emission when a 51 m separation distance is respected between the Aerial UE and the Aircraft (RA antenna).

The calculated signal level within RA reception band with MCL method is -107.1 dBm/MHz. The in-band protection level given in this Report is -107 dBm/MHz.

As a conclusion, there is no risk of interference to Radio Altimeters caused by the emission from aerial UE spurious emissions when a separation distance greater than 51 m is respected.

A2.4 CONCLUSIONS

The MCL calculation results show that there is no risk of interference from an aerial UE possible spurious emission to Radio Altimeters when the separation distance is greater than 51 meters for an aerial UE transmitting over 5 MHz.

This result doesn't prejudge on the potential impact from the 5G base station emission communicating with the aerial UE.

ANNEX 3: (STUDY B) RADIO ALTIMETER COMPATIBILITY STUDY WITH MFCN AT 3.4-3.8 GHz AND WBB LMP AT 3.8-4.2 GHz FOR UNWANTED AND BLOCKING EFFECT CONFIGURATIONS WITH RADIO ALTIMETER PARAMETER SET 2

The present annex uses the Radio Altimeter Parameter Set 2. First, the interference scenario is detailed and then the study methodology is presented. Results of the compatibility studies are presented for both MFCN operated in the frequency band 3.4-3.8 GHz and WBB LMP in the frequency bands 3.8-4.1 GHz and 4.1-4.2 GHz.

A3.1 BASE STATION PARAMETERS

Table 18 aggregates the technical and operational characteristics of:

- The MFCN base stations in the 3.4-3.8 GHz band for four deployment types: Rural, Urban, Suburban Macro and Urban Micro. Indoor cells are not considered.
- The WBB LMP base stations in the 3.8-4.2 GHz band for two deployment types: low power and medium power. The parameters are based on ECC Report 358 [15].

Table 18: Summary of the used base station characteristics in MFCN and WBB LMP bands

Parameter	MFCN 3.4-3.8 GHz				WBB LMP 3.8-4.2 GHz	
	Rural Macro	Suburban macro	Urban macro	Urban Micro	Low Power	Medium Power
Bandwidth BW (MHz)	100					
<i>e.i.r.p.</i> at boresight (dBm)	72.28 or 78 (Note 1)			61.53	31	51
Antenna height h_{AAS} (m)	up to 35	up to 25	up to 20	up to 6	up to 10	up to 30
Antenna model	Sub-array (SA) (Note 2)			No SA (Note 2)	No AAS (MIMO 4x4)	No AAS (MIMO (4x4)) AAS with SA AAS no SA
Mechanical downtilt (degrees) (Note 6)	0				3	
Horizontal coverage range (degrees)	$\pm 60^\circ$ ($\varphi_{coverage} = 60^\circ$)					
Vertical coverage range (degrees) (Notes 3 ,4)	90° (Note 5) to 120° ($\theta_{coverage} = 30^\circ$)					
<p>Note 1: 78 dBm is the typical <i>e.i.r.p.</i> value of 5G currently deployed in France.</p> <p>Note 2: TRP calculation takes into account 26.2 dBi antenna gain for AAS with Sub-array (SA) and 24.5 dBi for AAS without SA.</p> <p>Note 3: The vertical coverage is given in global coordinate system, i.e. 90° being horizon.</p> <p>Note 4: The vertical coverage includes the mechanical downtilt</p> <p>Note 5: There is currently no regulation limiting the AAS pointing direction above the horizon, so cases where the vertical coverage angles are lower than 90° (above the horizon) must be considered as well.</p> <p>Note 6: The mechanical tilt value is different from the ECC Report 358 and the WBB LMP parameters in section 3.1.1.</p>						

A3.1.1 AAS characteristics

The AAS models and parameters are provided in Table 19 and Table 20.

Table 19: Beamforming antenna characteristics for MFCN in 1710-4990 MHz

Parameter	Notation	With Sub-array (SA)	No sub-array (SA)
Antenna pattern (dBi)	G_{AAS}	Extended AAS Model 3GPP TR 38.803 , section 5.2.3.2.4 [34], reported in Table 20.	Refer to Recommendation ITU-R M.2101, section 5
Gain at boresight	$\max G_{AAS}$	26.2 dBi	24.5 dBi
Element gain (dBi) (Note 1)	$G_{E,max}$	6.4	
Antenna polarisation	N/A	Linear $\pm 45^\circ$	
Array Ohmic loss (dB) (Note 1)	N/A	2	
Horizontal/vertical 3 dB beam width of single element (Degree)	$\varphi_{3db} / \theta_{3db}$	90° for H, 65° for V	
Horizontal/vertical front-to-back ratio (dB)	A_m, SLA_v	30 dB for both H/V	
Antenna polarisation	N/A	Linear $\pm 45^\circ$	
Antenna array configuration (Row \times Column), Note 2	$M \times N$	4 \times 8 elements	8 \times 8 elements
Horizontal/Vertical radiating element/sub-array spacing	d_h, d_v	0.5 of wavelength for H, 2.1 of wavelength for V	0.5 of wavelength for H, 0.7 of wavelength for V
Number of element rows in sub-array,	M_{sub}	3	0
Vertical radiating element spacing in sub-array	$d_{v,sub}$	0.7 of wavelength of V	N/A
Pre-set sub-array down-tilt, θ subtilt (degrees)	$\theta_{subtilt}$	3	N/A
<p>Note 1: The element gain includes the ohmic loss and is per polarisation. This means that this ohmic loss parameter is not needed for the calculation of the BS composite antenna gain and <i>e.i.r.p.</i></p> <p>Note 2: For the small/micro cell case, 8 \times 8 means there are 8 vertical and 8 horizontal radiating elements. For the extended AAS model case, 4 \times 8 means there are 4 vertical and 8 horizontal radiating sub-arrays.</p>			

Table 20: Extended AAS model

Description	Equation
Peak normalised element radiation pattern	$A(\theta, \varphi) = -\min \left[-\left(-\min \left[12 \left(\frac{\varphi}{\varphi_{3dB}} \right)^2, A_m \right] - \min \left[12 \left(\frac{\theta - 90}{\theta_{3dB}} \right)^2, SLA_v \right] \right), A_m \right]$
Peak gain normalized element radiation pattern	$A_E(\theta, \varphi) = G_{E,max} + A(\theta, \varphi)$
Sub-array excitation	$w_m = \frac{1}{\sqrt{M_{sub}}} \exp \left(j2\pi(m-1) \frac{d_{v,sub}}{\lambda} \sin(\theta_{subtilt}) \right)$

Description	Equation
Sub-array radiation pattern	$A_{sub}(\theta, \varphi) = A_E(\theta, \varphi) + 10\log_{10} \left(\left \sum_{m=1}^{M_{sub}} w_m v_m \right ^2 \right)$ <p>where:</p> $v_m = \exp \left(j2\pi(m-1) \frac{d_{v,sub}}{\lambda} \cos(\theta) \right)$
Array excitation	$w_{m,n} = \frac{1}{\sqrt{MN}} \exp \left(j2\pi \left((m-1) \frac{d_v}{\lambda} \sin(\theta_{etilt}) - (n-1) \frac{d_h}{\lambda} \cos(\theta_{etilt}) \sin(\varphi_{escan}) \right) \right)$
Composite array radiation pattern	$A_A(\theta, \varphi) = A_{sub}(\theta, \varphi) + 10\log_{10} \left(\left \sum_{m=1}^M \sum_{n=1}^N w_{m,n} v_{m,n} \right ^2 \right)$ <p>where:</p> $v_{m,n} = \exp \left(j2\pi \left((m-1) \frac{d_v}{\lambda} \cos(\theta) + (n-1) \frac{d_h}{\lambda} \sin(\theta) \sin(\varphi) \right) \right)$

A3.1.2 Non-AAS characteristics

The non-AAS antenna characteristics are taken from ECC Report 358 [15].

Table 21: Directional WBB LMP base station non-AAS antenna characteristics

Non-AAS Antenna Pattern	Recommendation ITU-R F.1336
Sectorisation	1 sector for single BS; tri-sector for network layout simulation
Non-AAS BS downtilt (degrees)	0 and 10
Frequency reuse	1
Non-AAS BS antenna pattern	Recommendation ITU-R F.1336 (recommends 3.1) ka = 0.7 kp = 0.7 kh = 0.7 kv = 0.3 Horizontal 3 dB beamwidth: 65 degrees Vertical 3 dB beamwidth: determined from the horizontal beamwidth by equations in Recommendation ITU-R F.1336. Vertical beamwidths of actual antennas may also be used when available.
Antenna polarisation	Linear $\pm 45^\circ$
Non-AAS BS Tx and Rx antenna gain per RF chain (including system loss)	10 dBi for Medium Range (MR) BS 6 dBi for Local Area (LA) BS 0 dBi (omni) for indoor BS

A3.1.3 UNWANTED EMISSION CHARACTERISTICS

The *e.i.r.p.* can be calculated from the in-band TRP based on Equation 2.

$$TRP \approx e.i.r.p. - \max G_{AAS}$$

Equation 2

For MFCN 3.4-3.8 GHz, the unwanted emissions are constrained by the Decision (EU) 2019/235 [6] and (ECC Decision 11(06) [8].

Other ECC studies involving WBB LMP base stations also extended the ECC Decision to the 3.8-4.2 GHz case. Table 22 shows the unwanted power limit above 4200 MHz for WBB LMP base stations. For base stations emitting in the 3.8-4.1 GHz band, the spurious power is limited to -9 dBm/MHz *e.i.r.p.* (non-AAS) or -21 dBm/MHz TRP (AAS).

Table 22: Power limit to be applied above 4200 MHz for non-AAS and AAS WBB LMP base stations

Frequency range (MHz)	Notation	<i>e.i.r.p.</i> limit in dBm/MHz per antenna	AAS TRP limit in dBm/MHz per cell (Note 1)
4200-4205	P_{OOB1} (dBm/MHz)	<i>e.i.r.p.</i> - 47 (Note 2)	TRP - 47 (Note 3)
4205-4240	P_{OOB2} (dBm/MHz)	<i>e.i.r.p.</i> - 50 (Note 2)	TRP - 50 (Note 3)
Above 4240	P_{OOB3} (dBm/MHz)	-9	-21

Note 1: In a multi-sector base station, the radiated power limit applies to each one of the individual sectors
 Note 2: *e.i.r.p.* is the maximum mean carrier power in dBm for the base station measured as *e.i.r.p.* per carrier, interpreted as per antenna.
 Note 3: TRP is the maximum mean carrier power in dBm for the base station measured as TRP per carrier in a given cell.

Another critical aspect when considering unwanted emissions concerns the antenna radiation pattern. The study assumes that the AAS directivity greatly decrease with increased frequency and converge to an isotropic antenna with $G_{AAS,spur} = 0$ dBi gain. This loss of directivity is significant after a frequency shift $\Delta F_{AAS,spur}$ that correspond to 1%-2% of the operating (carrier) frequency. For a frequency carrier of 4150 MHz, this corresponds to a frequency shift comprised between $\Delta F_{AAS,spur} \approx 40$ MHz to 80 MHz.

This study assumed that after an offset of 80 MHz the AAS model is assumed to behave like an isotropic antenna ($\Delta F_{AAS,spur} = 80$ MHz, with $G_{AAS,spur} = 0$ dBi gain).

Table 23 summarises the type of AAS model to be used depending on the frequency range being studied.

Table 23: AAS model to be used depending on the studied frequency ranges

Base station (100 MHz bandwidth)	Studied frequency range	AAS model
MFCN @3750 GHz carrier	3700 - $(3800 + \Delta F_{AAS,spur})$ MHz	Table 35
	Above $(3800 + \Delta F_{AAS,spur})$ MHz	Isotropic $G_{AAS,spur}$ dBi
WBB LMP @4050 MHz carrier	4000 - $(4100 + \Delta F_{AAS,spur})$ MHz	Table 35
	Above $(4100 + \Delta F_{AAS,spur})$ MHz	Isotropic $G_{AAS,spur}$ dBi
WBB LMP @4150 MHz carrier	4100 - $(4200 + \Delta F_{AAS,spur})$ MHz	Table 35

Base station (100 MHz bandwidth)	Studied frequency range	AAS model
	Above $4200 + \Delta F_{AAS,spur}$ MHz	Isotropic $G_{AAS,spur}$ dBi

A3.2 RADIO ALTIMETER PARAMETERS

A3.2.1 Interference tolerance Threshold (Parameter Set 2)

Parameter Set 2 considers the breakpoint values reported in AVSI Vol. 1 and Vol. 2 where all breakpoint measures, clearly reported in tables, are obtained through the same measurement setup for all RA models and can be compared. In AVSI Vol. 3, measurements are performed by different manufacturers, each using different setups that differ from the one defined in the first two reports, making them difficult (if not impossible) to compare.

The breakpoint values reported in Table 24 corresponds to the breakpoint values of the most sensitive Radio Altimeter for a given band and height. In AVSI reports, breakpoint values are reported in dBm, so 20 dB (100 MHz bandwidth measure at 3.4-4.2 GHz) or 22 dB (160 MHz bandwidth measure at 4.2-4.4 GHz) must be subtracted to convert in dBm/MHz.

It should be noted that, for the frequency band 4.1-4.2 GHz band, no breakpoint data is available in AVSI reports Vol. 1 and 2. In AVSI Vol. 3, breakpoint values are only available for models F and T, which is not representative of all RA models. In addition, model F is less sensitive in the 4.1-4.2 GHz band than in 3.8-4.1 GHz band, which is strange behaviour as it is closer to the RA operating band. It does not guarantee that other models follow the same behaviour. Therefore, in the absence of clear information, Parameter Set 2 assumes that the breakpoint values obtained in the 3.8-4.1 GHz band also applies for the 4.1-4.2 GHz band.

Table 24: ITT values for Parameter Set 2 in dBm/MHz

Frequency band (GHz)	200 feet	1000 feet	Source
3.4-3.8	-39	-46	Vol AVSI. I; Table 3-1, Altimeter F @3750 MHz
3.8-4.1	-42	-48	Vol AVSI. I; Table 3-1, Altimeter F @3930 MHz
4.1-4.2	-42	-48	
4.2-4.4	-76	-85	AVSI Report Vol 2 Table 4-2, 200 feet: Altimeter L, 1000 feet: Altimeter F.

A3.2.2 Altimeter antenna radiation pattern

A3.2.2.1 Antenna radiation pattern

Table 25: Antenna model for Parameter Set 2

Frequency Range (GHz)	3.4-3.8	3.8-4.1	4.1-4.2	4.2-4.4
Antenna Gain $G_{RA,max}$ (dBi)	0	3	8	10

Frequency Range (GHz)	3.4-3.8	3.8-4.1	4.1-4.2	4.2-4.4
	Antenna pattern: Omni incl. cable loss	Antenna pattern: Omni incl. cable loss	Antenna pattern: Report ITU-R M.2319 (A-3.6 with $\Delta\theta_{3dB} = 60^\circ$ at 3 dB) And 3 dB cable loss	Antenna pattern: Report ITU-R M.2319 (A-3.6 with $\Delta\theta_{3dB} = 60^\circ$ at 3 dB) And 3 dB cable loss

The antenna radiation pattern from Report ITU-R M.2319 is given by the following equation

$$G_{RA}(\theta) = G_{RA,max} - 12 \times \left(\frac{\theta}{\Delta\theta_{3dB}} \right)^2$$

Equation 3

A3.3 INTERFERENCE SCENARIO AND GEOMETRICAL ASSUMPTIONS

This section presents the scenario of a 5G base station to assess the level of interference to a Radio Altimeter embedded on an aircraft. The geographic environment is an airport runway and is considered to be a flat surface. The following elements constitutes the interference scenario:

- A (x,y,z) coordinate system is associated to the landing field, with its origin at the Touch Down Point (TDP). The x-axis corresponds to the runway direction, the y-axis for the lateral direction and the z-axis for the vertical dimension (positive toward up);
- A 5G antenna of height h_{AAS} , mounted on a BS at distance d_{BS} from the TDP along the runway and L_{BS} along the lateral direction is therefore referenced by the 3D coordinate $(d_{BS}, L_{BS}, h_{AAS})$;
- The AAS mechanically down-tilted by θ_{mtilt} degrees. The value is set to 0 in the study leading to a horizontal pointing without electrical tilt. This base station is the RF interferer in this scenario;
- If the base station antenna height h_{AAS} exceeds the OLS limitations (see Figure 11 then the base station height value is reduced to the OLS height;
- The aircraft trajectory is considered to be a straight line elevated at $\theta_{glide} = 2.625^\circ$ ($3 - 0.375^\circ$ Instrument Landing System tolerance) from the runway plane¹². This corresponds to a nominal trajectory that minimises the distance – and by extension the free space propagation loss – between the aircraft and the BS;
- A Radio Altimeter (RA) embedded in the aircraft and is the RF system to protect;
- The BS coverage is defined with the horizontal and vertical coverage angles $(\varphi_{coverage}, \theta_{coverage})$ from the BS;
- The UE interference power received by the radio altimeter is considered negligible compared to the BS interfering power;
- Each element interacts as illustrated in Figure 10. The 5G base station is communicating with the UE either in 3.4-3.8 GHz band (MFCN) or 3.8-4.2 GHz band (WBB LMP). Consequently, the AAS beam steering is pointed toward the UE direction defined by the azimuth angle φ_{UE} and elevation angles θ_{UE} (see Figure 10 for how they are defined). The beam steering angles cannot exceed the BS coverage ranges, implying $-\varphi_{coverage} \leq \varphi_{UE} \leq \varphi_{coverage}$ and $0 \leq \theta_{UE} \leq \theta_{coverage}$. Part of the BS power is radiated as interference towards the RAs at distance d_{AAS-RA} and elevation angle θ_{AAS-RA} . Both of these geometrical metrics evolve with the aircraft height AGL , so the RA must be protected for all positions of the aircraft landing trajectory;
- The maximum interference at any phase of the aircraft landing is obtained by assuming that the served UE is in the same vertical plane with the BS and the aircraft. Thus, the AAS antenna is always pointing, in azimuth, towards the RA, i.e. the AAS → RA azimuth angle is always equal to 0;
- The aircraft maximum roll angle (in absolute value) is assumed to be $\theta_{roll,max} = 15^\circ$ above 100 feet and be $\theta_{roll,max} = 10^\circ$ below 100 feet. No pitch angles are considered;
- The Radio Altimeter follows the same trajectory as the aircraft;

¹² The glide angle was reported to be 2° in some airport although this does not correspond to the majority cases.

- The base station antenna beam is assumed to not point above the horizon (0°);
- Multi-path components coming from reflections and diffractions in the propagation environment (ground, building, trees...) are neglected. Only the line of sight is considered. Therefore, the free-path loss channel propagation model ([Recommendation ITU-R P.525-4](#) [45]) is considered.

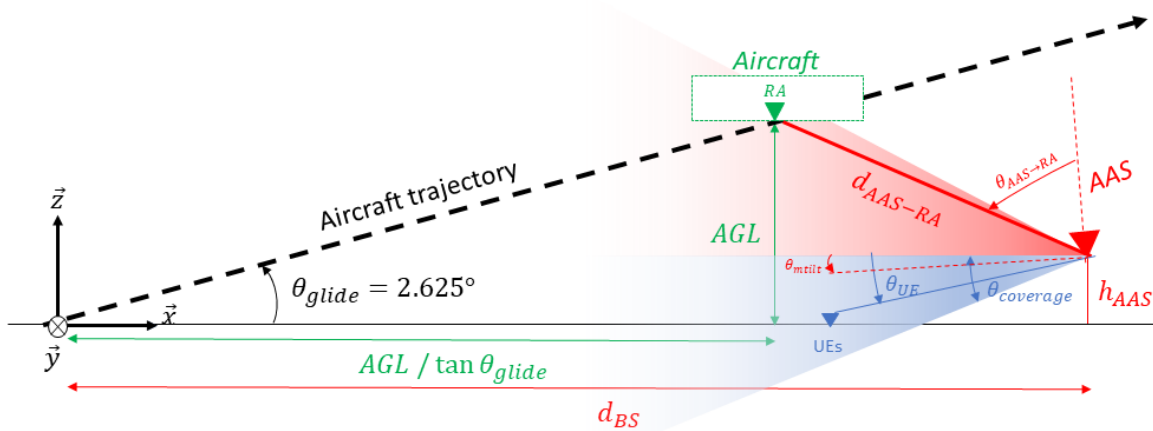

Figure 10: Representation of the interference scenario, shown in the aircraft trajectory - runway plane

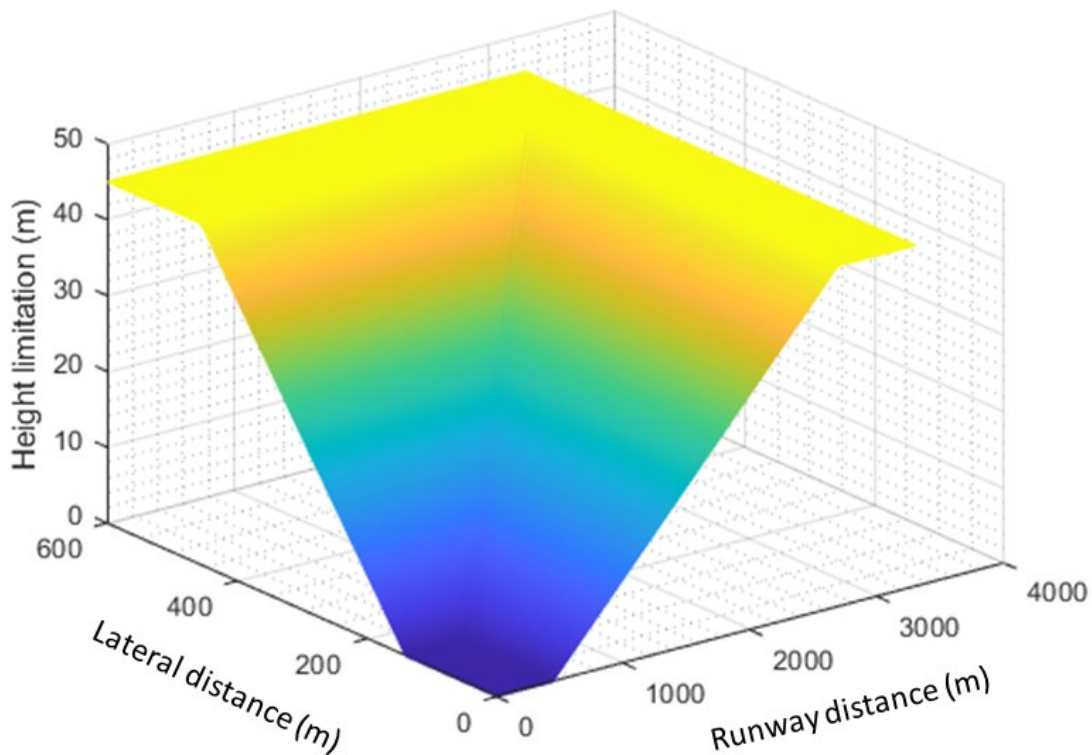

Figure 11: Obstacle Limitation Surface (OLS) applied to base station height

A3.4 METHODOLOGY OF THE STUDIES

For compatibility studies, these systems have to be considered:

- The MCFN operating at 3400-3800 MHz;
- The WBB LMP operating at 3800-4200 MHz;
- The Radio Altimeter operating band within 4200-4400 MHz.

For compatibility studies with MCFN base stations, the Radio Altimeter protection is ensured if and only if the following conditions are fulfilled:

- 1 The interference power from the base station, in-band emissions, do not cross the interference tolerance thresholds (ITT) of the radio altimeter defined in the 3400-3800 MHz band, at any height lower than 1000 feet. This case will be referred to as “In-Band” MCFN study.
- 2 The interference power of the base station spurious emissions does not cross the interference tolerance thresholds (ITT) of the Radio Altimeter in its operating band 4200-4400 MHz. This case will be referred to as “Adjacent-Band” MCFN study.

Similarly, for compatibility studies with WBB LMP base stations, the Radio Altimeter protection is ensured if and only if the following conditions are fulfilled

- 3 The interference power from the base station in-band emission does not cross the interference tolerance thresholds (ITT) of the RA defined in the 3800-4200 MHz band at any height lower than 1000 feet. This case will be referred to as “In-Band” WBB LMP study.
- 4 The interference power of the base station spurious (or OOB) emission does not cross the interference tolerance thresholds (ITT) of the RA in its operating band 4200-4400 MHz. This case will be referred to as “Adjacent-Band” WBB LMP study.
- 5 In the following, the methodology for computing the base station interfering power at the level of the RA, deriving the power margin and determining the corresponding protection region, if needed, is provided for the general case. Then, special case applications are presented in a simplified methodology to gain insight on key configurations causing the highest interference.

A3.4.1 Interference calculation

For a given BS position and RA height, the interference caused by the BS on the RA can be computed by means of the following equation:

$$IP(f, D_{BS}, L_{BS}, AGL) = \underbrace{TRP_{BS} + \max_{\theta_{etilt}} G_{AAS}(\theta_{AAS \rightarrow RA}, f)}_{EIRP(\theta_{AAS \rightarrow RA}, f)} + \max_{\theta_{roll}} G_{RA}(\Psi(\theta_{roll}), f) - L_c - \underbrace{(32.4 + 20 \log_{10}(d_{BS-RA} f))}_{FSPL(ITU-R P.525-4)}$$

Equation 4

Where:

- TRP_{BS} (dBm) is the base station radiated power calculated for a bandwidth of BW (MHz). This TRP is modified according to whether an “In-Band” or an “Adjacent-Band” type study is conducted;
- $\max_{\theta_{etilt}} G_{AAS}(\theta_{AAS \rightarrow RA}, f)$ (dBi) is the antenna gain in direction of the RA by taking the envelope of the AAS gain diagram over base station antenna gain;
- $\theta_{BS \rightarrow RA}$ is the elevation angle of the RA relatively to the AAS;
- $\max_{\theta_{roll}} G_{RA}(\Psi(\theta_{roll}), f)$ (dBi) is the radio altimeter antenna gain by which the BS interfering is received, it is obtained by taking the envelope from the radio altimeter antenna pattern and the aircraft roll angles;
- $\Psi(\theta_{roll})$ is the off-axis angle by which the AAS is seen from the RA, including the aircraft roll;
- AGL (km) is the is the Above Ground Level of the aircraft;
- L_c (dB) is the radio altimeter antenna cable loss;
- f (GHz) is the frequency where the study is performed for RA protection;
- d_{BS-RA} (m): distance between the BS and the RA. $d_{BS-RA} = \sqrt{\left(\left(\frac{AGL}{\tan(2.625^\circ)} - D_{BS}\right)^2 + L_{BS}^2 + (AGL - h_{AAS})^2\right)}$.

As it can be seen, the interference depends on the relative positions between the BS and RA as it affects the distance and the angles by which the BS sees the RA and the RA sees the BS. More details on the derivation of the AAS antenna gain envelop is provided in the Addendum in section A3.8.

A3.4.2 Calculation of the power margin

To compute the power margin P_{margin} the ΔPFD_{margin} is introduced, a metric that indicates the minimum difference between the interference tolerance threshold (ITT) of the RA (in dBm) and the interfering power of BS, for all aircraft height AGL (feet) at a given base station deployment distance position (D_{BS}, L_{BS}) . It is calculated as follows

$$\Delta PFD_{margin}(f, D_{BS}, L_{BS}) = \min_{AGL \in \mathcal{L}_{AGL}} (\Delta P(f, D_{BS}, L_{BS}, AGL))$$

Equation 5

Where:

- \mathcal{L}_{AGL} is the set of aircraft height to be evaluated,
- ΔP (dB) is the difference between the ITT and the base station interfering power, it is function of the operating frequency, BS position and aircraft height with its expression given by:

$$\Delta P(f, D_{BS}, L_{BS}, AGL) = ITT_{itp}(f, AGL) - IP(f, D_{BS}, L_{BS}, AGL) + \begin{cases} 20 & \text{if } f < 4200 \text{ MHz} \\ 23 & \text{if } f > 4200 \text{ MHz} \end{cases}$$

Equation 6

where ITT_{itp} corresponds to the interpolated ITT obtained by interpolating, in log-domain, the ITT values at 200 and 1000 feet defined in section A3.2. This interpolation is calculated as follows

$$ITT_{itp}(f, AGL) = \begin{cases} 10 \log_{10}(AGL) \times A(f) + B(f) & \text{if } AGL > 200 \text{ ft} \\ ITT_{itp}(f, 200) & \text{if } AGL \leq 200 \text{ feet} \end{cases}$$

Equation 7

with

$$A(f) = \frac{ITT(f, 1000ft) - ITT(f, 200ft)}{7}, B(f) = ITT(f, 200ft) - 17.85 \times A(f).$$

Equation 8

This interpolation method is the one proposed in RTCA Paper No. 274-20/PMC-2073¹³, section 9.1.1 [23] by aeronautic experts. ΔPFD can be numerically evaluated through the following steps:

- Define $N_{AGL} = 1000$ height points indexed $k = 0$ to $k = N_{AGL} - 1$;
- For each height point k , calculate the height $AGL(k) = 0.304 \times k / (N_{AGL} - 1)$;
- For each height point k , calculate $\Delta P(f, D_{BS}, L_{BS}, AGL)$ from Equation above. The base station interference $IP(f, AGL)$ is obtained by applying one of the methodologies described in the previous sections where the input parameter AGL is set to $AGL(k)$;
- From all calculated $\Delta P(f, D_{BS}, L_{BS}, AGL(k))$ values, takes the minimum. This corresponds to ΔPFD_{margin} .

If $\Delta PFD_{margin}(f, D_{BS}, L_{BS}) > 0$, then RAs are protected for a given base station deployment (D_{BS}, L_{BS}) . Otherwise, the power margin value indicates by how much the base station power needs to be reduced in order to protect the RAs. Other indirect way to improve the margin power are as follows:

- Moving the BS further away from the TDP of the runway;
- Increasing the mechanical down tilt;
- Limiting the AAS coverage to reduce the grating lobes power;
- Adding a guard-band (for an adjacent band study, WBB LMP 4.1-4.2 GHz).

¹³ ©RTCA, Inc. Used with permission. All rights reserved.

For each (D_{BS}, L_{BS}) base station locations, the global power margin P_{margin} of the considered deployment scenario can be calculated through:

$$P_{margin} = \min_{(D_{BS}, L_{BS}) \in \mathcal{A}} \Delta PFD_{margin}(f, D_{BS}, L_{BS})$$

Equation 9

Where:

- \mathcal{A} is the space of possible BS deployment positions.

A3.4.3 Deriving the coordination zones

The coordination lateral distance L_{coord} is the minimum distance ensuring that the power margin is always superior to the ICAO safety margin S_{margin} of 6 dB for all possible base station distances D_{BS} (runway axis) and lateral distances L_{BS} superior to L_{coord} :

$$\min_{D_{BS}, L_{BS} > L_{coord}} \left(\Delta PFD_{margin}(D_{BS}, L_{BS}) \right) > S_{margin}$$

Equation 10

Similarly, the coordination distance D_{coord} is the minimum distance ensuring that the power margin is always superior to the ICAO safety margin S_{margin} of 6 dB for all possible base station lateral distance L_{BS} and runway axis distance D_{BS} superior to D_{coord} :

$$\min_{D_{BS} > D_{coord}, L_{BS}} \left(\Delta PFD_{margin}(D_{BS}, L_{BS}) \right) > S_{margin}$$

Equation 11

A3.4.4 Simplified methodology

In some base station deployment setups, the dominant base station interfering power corresponds to the case where the Radio Altimeter is nearly aligned with the maximum gain of the BS, or the BS is nearly aligned with the maximum gain of the RA. The following examples illustrate each scenario and provide the simplified methodology applicable to derive the coordination region.

A3.4.4.1 In-Band case – RA protection in 3400-3800 MHz -- Interference calculation method: boresight (base station) – Aircraft below 200 feet

If the base station is located at a lateral distance L_{BS} higher than 140 m (OBZ limitation), then there is always an instant where the radio altimeter antenna (omni-directional) is within the boresight beam of the AAS antenna during the final landing approach phase. Therefore, the interfering power can be obtained by simplifying Equation 4 as follows:

$$IP_{boresight} = TRP_{BS}(f) + G_{BS,max}(f) + G_{RA}(f) - L_c - 32.4 - 20 \log_{10}(D \times f)$$

Equation 12

Where:

- TRP_{BS} (dBm) is the base station conducted power calculated for a bandwidth of BW (MHz);
- $G_{BS,max}$ (dBi) is the boresight base station antenna gain;
- G_{RA} (dBi) is the Radio Altimeter antenna gain;
- AGL (feet) is the height of the aircraft;
- L_c (dB) is the radioaltimeter antenna cable loss;

- f (MHz) is the frequency where the study is performed for RA protection;
- D (km) is the distance between the BS and the RA. If the base station is positioned in the lateral axis from the runway, then $D = L_{BS}$. If the base station is positioned in the runway axis, then $D = D_{BS} - H_{RA}/\tan(2.625^\circ)$, with $H_{RA} = AGL \times 3.048 \times 10^{-4}$.

As the final landing approach is a critical phase where the height reported by the Radio Altimeter can be used for automatic landing, the ICAO safety margin of 6 dB is considered.

Consequently, the minimum lateral deployment distance (L_{coord} , km), referred to as lateral coordination distance L_{coord} , corresponds to the distance where the interfering power is equals to the interference tolerance threshold with the 6 dB ICAO safety margin:

$$ITT(f, 200) - S_{margin} = EIRP_{BS}(f) + G_{RA}(f) - L_C - 32.4 - 20 \log_{10}(L_{coord} \times f)$$

Equation 13

The lateral coordination distance can then be calculated from the following equation:

$$L_{coord} = \frac{1}{f} 10^{\frac{(EIRP_{BS}(f) + G_{RA}(f) - ITT(f, 200) + S_{margin} - 32.4)}{20}}$$

Equation 14

Where:

- $EIRP_{BS}$ (dBm) is the base station transmitted power at boresight, calculated for a bandwidth of 100 MHz;
- $f = 3750$ MHz is the base station carrier frequency;
- G_{RA} (dBi) is the Radio Altimeter antenna gain at $f = 3750$ MHz;
- $S_{margin} = 6$ dB is the ICAO safety margin;
- f (MHz) is the frequency where the study is performed for RA protection.

This method also applies for calculating the critical deployment distance along the runway axis (referred to as coordination distance D_{coord}) when the aircraft height is 200 feet. In this case, the distance between the RA and the BS is close to L_{coord} :

$$D_{coord} = L_{coord} + 1.33 \text{ (km)}$$

Equation 15

Where 1.33 km is the horizontal distance between the TDP and the aircraft when the aircraft height is 200 feet AGL.

A3.4.4.2 Adjacent-band case – RA protection in 4200-4400 MHz Interference calculation method: boresight (Radio Altimeter)

In the spurious domain, the base station AAS tends to become omni-directional with 0 dBi gain. Therefore, the considered scenario is when the aircraft is located directly above the base station deployed on the runway axis. This implies that the angle between the Radio Altimeter and the base station is 0° (in the Radio Altimeter coordinate base). This corresponds to the antenna boresight with maximum gain $G_{RA}(0^\circ) = G_{RA,max}$. In addition, the distance between the Radio Altimeter and the base station is minimal. Therefore, the attenuation due to free space path loss is also minimized. The power margin can then be calculated using:

$$IP_{boresight} = TRP_{BS,spur} + G_{RA,max}(f) - L_C - 32.4 - 20 \log_{10}(\Delta H \times f)$$

Equation 16

Where:

- TRP_{BS} (dBm or dBm/MHz) is the base station spurious TRP emission calculated for a bandwidth of 200 MHz;
- $f = 4300$ MHz is the Radio Altimeter carrier frequency;
- $G_{RA,max}(f)$ (dBi) is the Radio Altimeter boresight gain at $f = 4300$ MHz;
- $L_c = 3$ dB is the cable loss;
- ΔH is the difference in height between the Radio Altimeter and the base station.
- Applying the ICAO safety margin of 6 dB, the critical difference in height $\Delta H_{critical}$ is

$$\Delta H_{critical} = \frac{1}{f} 10^{\frac{TRP_{BS,spur} + G_{RA,max}(f) - L_c - ITT(f,200) + S_{margin} - 32.4}{20}}$$

Equation 17

Where:

- $ITT(f, 200)$ is the interference tolerance threshold at 200 feet, frequency $f = 4300$ MHz, expressed in dBm or dBm/MHz depending on the unit chosen for $TRP_{BS,spur}$.
- If $\Delta H_{critical} < 0.02$ km, the RA is guaranteed to be protected since it's not possible to have a distance base station to the Radio Altimeter less than 20 m due to OBZ limitations. Therefore, no coordination distance must be defined.
- If $0.02 \leq \Delta H_{critical} \leq 0.044$ km, then the coordination distance D_{Coord} is

$$D_{coord} = \frac{\Delta H_{critical} - 0.44 \tan 1.146^\circ}{\tan 2.625^\circ - \tan 1.146^\circ}$$

Equation 18

Figure 12 provides an illustration about how this coordination distance is geometrically calculated. Considering the maximum roll value that can be taken by the aircraft during the landing phase, the lateral distance can be obtained through the following equation

$$L_{coord} = \Delta H_{critical} \times \tan(90^\circ - \theta_{roll,max})$$

Equation 19

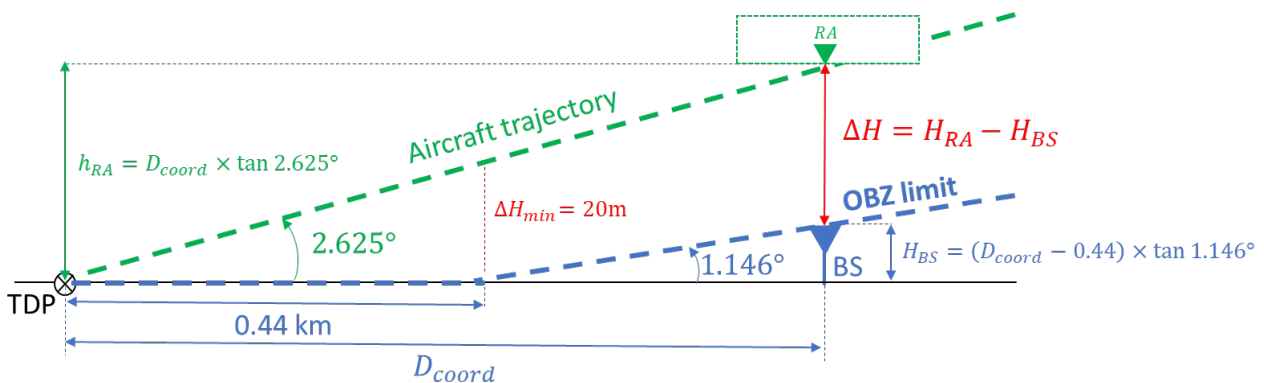

Figure 12: Illustration of the coordination distance calculation for the adjacent band study

A3.4.4.3 In-Band case – RA protection in 3400-3800 MHz – Interference calculation method: runway axis - Aircraft between 200 feet and 1000 feet

The considered scenario corresponds to the case where the base station is located within the runway axis. In such case, grating lobes from the AAS need to be carefully taken into consideration. For each possible base station deployment distance D_{BS} , a power margin $\Delta P_{margin}(D_{BS})$ can be calculated (see section A3.4.2). The

base station transmitted power $EIRP_{BS}$ in dBm, measured on $BW = 100$ MHz bandwidth is function of the BS TRP (dBm) and the antenna gain taken from an antenna radiation pattern envelope $G_{AAS,max}$ at elevation angle $\theta_{AAS \rightarrow RA}$, between the AAS and the RA:

$$EIRP(\theta_{AAS \rightarrow RA}, f) = TRP_{BS} + G_{AAS,max}(\theta_{AAS \rightarrow RA}, f)$$

Equation 20

Where:

- TRP_{BS} in dBm (100 MHz bandwidth) is the base station conducted power taken from Table 10.

An example of interference calculation for a fixed BS distance is given at the end of this section. The critical deployment distance $D_{critical}$ (km) is obtained by finding the BS distance from the TDP such that $\Delta P_{margin}(D_{critical}) = 0$ and $\Delta P_{margin}(D_{BS}) > 0$ if $D_{BS} > D_{critical}$. At this critical distance, the aircraft height where the interfering power is maximal can be identified as $AGL_{critical}$ (feet). The critical lateral distance can then be calculated as follows:

$$L_{critical} = D_{critical} - \frac{AGL_{critical} \times 3.048 \times 10^{-4}}{\tan(2.625^\circ)}$$

Equation 21

A3.4.5 Example of the interference calculation

This section aims to provide a numerical application of the methodology detailed in section A3.4 for a MFCN Rural Macro base station (see Table 19 and Table 20 for relevant parameters), in-band study. This example is based on the following assumptions:

- Base station emitted at 78 dBm *e.i.r.p.*;
- RA breakpoints from Parameter Set 2, with $U\&T_f = 4$ dB;
- The base station location is aligned with the runway axis, presenting its maximum gain toward the runway. The base station is located at $d_{BS} = 2.3$ km from the runway TDP as an example;
- The AAS envelope shown in the Addendum in section A3.8 is considered;
- Aircraft roll fixed to 0° (only for this example);
- No addition protection level applied to RA breakpoint values (i.e. $S_f = 0$ dB).

The interfering power of the BS as a function of the aircraft height AGL ($IP_{BS}(f, AGL)$) is displayed as a curve in the upper part of Figure 13. Two height points are worth being analysed in this scenario:

- AGL point 1 at 230 feet that corresponds to the height where the RA is within (or close to) the boresight beam width of the BS and where the most interfering power is radiated;
- AGL point 2 at 329 feet that corresponds to the height where the interfering power is maximum in this scenario.

As illustrated in Figure 13 the highest interfering power level is due to the AAS secondary lobes (grating lobes). This implies that AAS envelope is of high important and need to be taken into accounts when developing methodologies. Particularly, AAS grating lobes may cause harmful interference to RAs depending on where the BS is deployed.

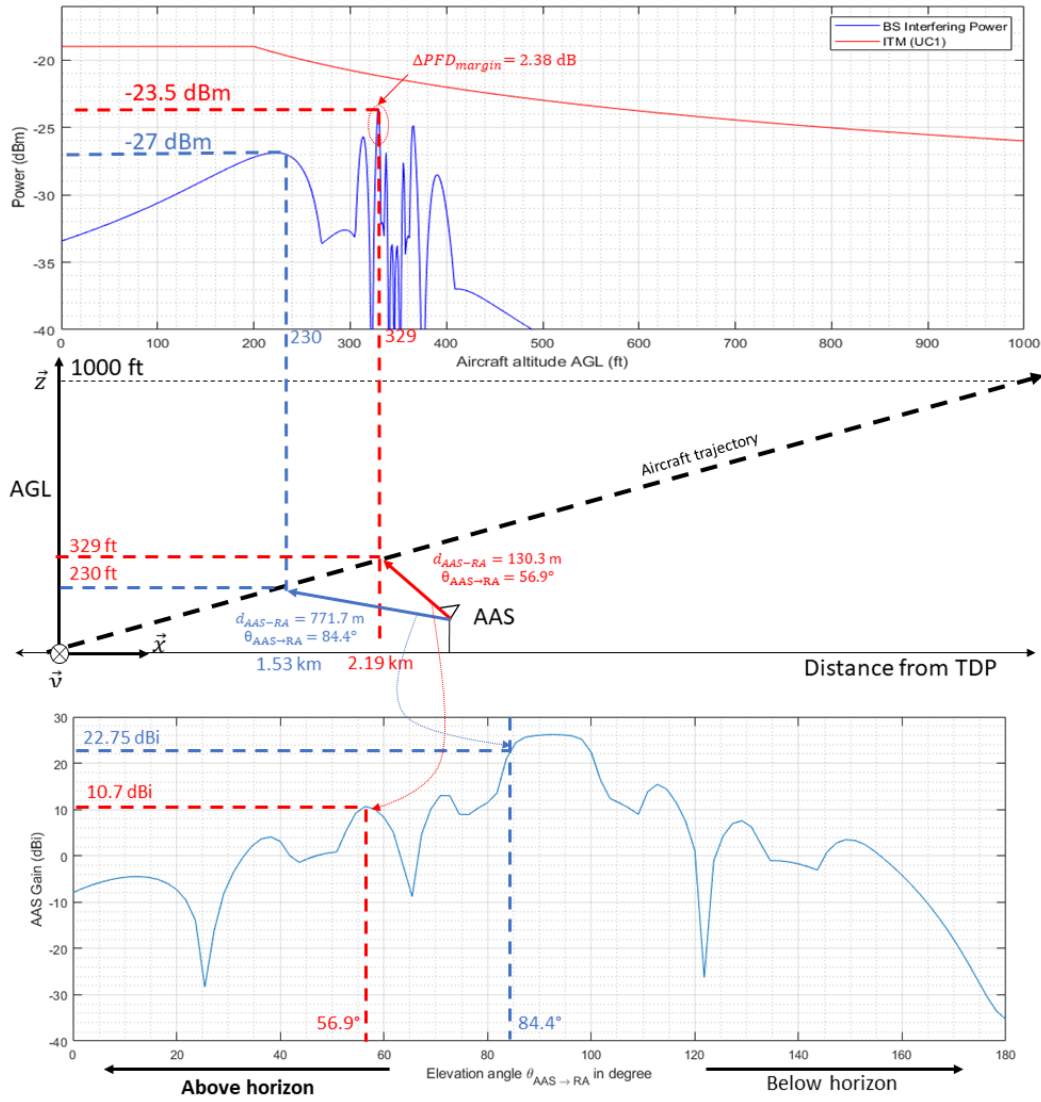

Figure 13: Illustration of the methodology applied to the MCFN Rural Macro BS located at 2.3 km from the runway TDP (power measured on 100 MHz bandwidth, centred at 3.75 GHz)

Table 26: Calculation details for two AGL points

Variable	Formula	AGL point 1: 230ft	AGL point 2: 329ft
d_{AAS-RA}	$d_{BAA-RA}^2 = (H_{RA} - H_{AAS})^2 + (\Delta x_{AAS-RA})^2$	771.7 m	130.3 m
Free space Path Loss	$32.4 + 20 \log_{10}(d_{BS-RA} f)$	-101.7 dB	-86.2 dB
$\theta_{AAS \rightarrow RA}$	$\theta_{AAS \rightarrow RA} = \text{atan}\left(\frac{\Delta x_{BS-RA}}{H_{RA} - H_{BS}}\right) - \theta_{\text{mtilt}}$	84.4°	56.9°
$G_{AAS,max}(\theta_{AAS \rightarrow RA})$	$\max_{\theta_{\text{etilt}}} G_{AAS}(\theta_{BS \rightarrow RA}, \theta_{\text{etilt}})$	22.75 dBi	10.7 dBi
$EIRP_{max}(\theta_{AAS \rightarrow RA})$	$EIRP_{max} - G_{AAS,max}(0) + G_{AAS,max}(\theta_{BS \rightarrow RA})$	74.75 dBm	62.7 dBm
$IP_{BS}(AGL)$	Equation 4	-27 dBm	-23.5 dBm

A3.5 RESULTS OF COMPATIBILITY STUDIES FOR MCFN BASE STATIONS (3400–3800 MHz)

A3.5.1 Aircraft below 200 feet

A3.5.1.1 In-band case – RA protection in 3400-3800 MHz

For MCFN base stations emitting at carrier frequency $f = 3750$ MHz, the parameter values for calculating security distance are:

- $ITT(f, 200 ft) = -19$ dBm (Parameter Set 2);
- $G_{RA}(f) = 0$ dBi (Parameter Set 2);
- $EIRP_{BS} = 78$ dBm;
- $S_{margin} = 6$ dB;
- No mechanical downtilt.
- Figure 14 shows the power margin obtained for every BS position using the methodology described in section A3.4.2.

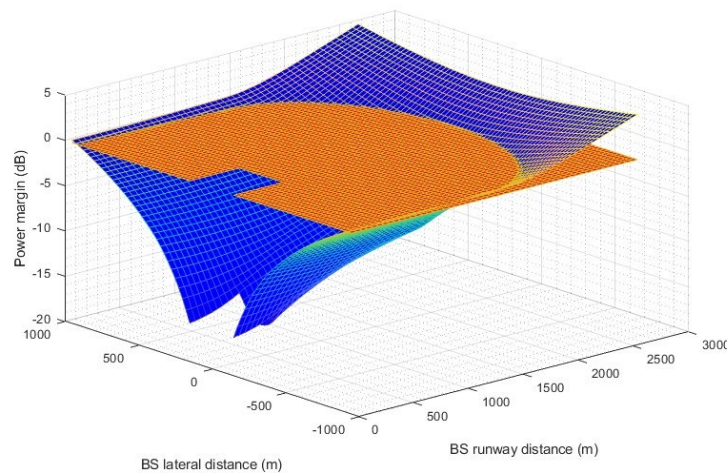

Figure 14: Power margin (dB) as a function of the BS position in the runway and lateral directions

Negative power margins are obtained, with a minimum of -16 dB with respect to the 6 dB ICAO safety margin. The interference caused by MCFN BSs is therefore problematic and requires thereby mitigation by either reducing the in-block power limit, or by constraining the mechanical downtilt, the deployment region of BS, etc... For a fixed *e.i.r.p.* of 78 dBm/MHz and a mechanical tilt going up to the horizon, a coordination region is defined where the BS should not be located. The coordination distances, rounded at the highest 10 m, are:

- $D_{coord} = 2.24$ km (distance from the TDP, runway axis);
- $L_{coord} = 0.94$ km (lateral distance, perpendicularly to the runway axis).

A3.5.1.2 Adjacent-band case – RA protection in 4200-4400 MHz

For MCFN base stations emitting at carrier frequency $f = 3750$ (MHz), the parameter values for calculating security distance are:

- $ITT(f, 200 ft) = -76$ dBm/MHz (Parameter Set 2);
- $G_{RA}(f) = 10$ dBi (Parameter Set 2);
- $L_C = 3$ dB;
- $TRP_{BS} = -21$ dBm/MHz.

The maximum interfering power corresponds to the case where the aircraft is above the base station in the runway axis. This corresponds to a critical height of $\Delta H_{critical} = 0.014$ km. Due to OBZ limitation, the minimum

height difference between the aircraft and the base station is $20\text{ m} > \Delta H_{critical}$. Consequently, there does not exist any situation where the base station spurious emissions cause harmful interference to Radio Altimeters. The minimum power margin is 3.6 dB, which can be calculated by taking the boresight interference applied for a distance base station – Radio Altimeter of 20 m.

A3.5.2 Aircraft between 200 feet and 1000 feet

A3.5.2.1 In-band case – RA protection in 3400-3800 MHz

The parameter values for calculating security distance in the preparation phase (aircraft between 200 feet and 1000 feet) are unchanged from when the airplane is in the landing phase with the exception of not including the ICAO safety margin of 6 dB.

Figure 15 shows at the left the interference profile with respect to the BS position and corresponding ITT values, and on the right the resulting harmful interference region of BS placements. The lowest power margin obtained is of -6.7 dB with respect to the ITT.

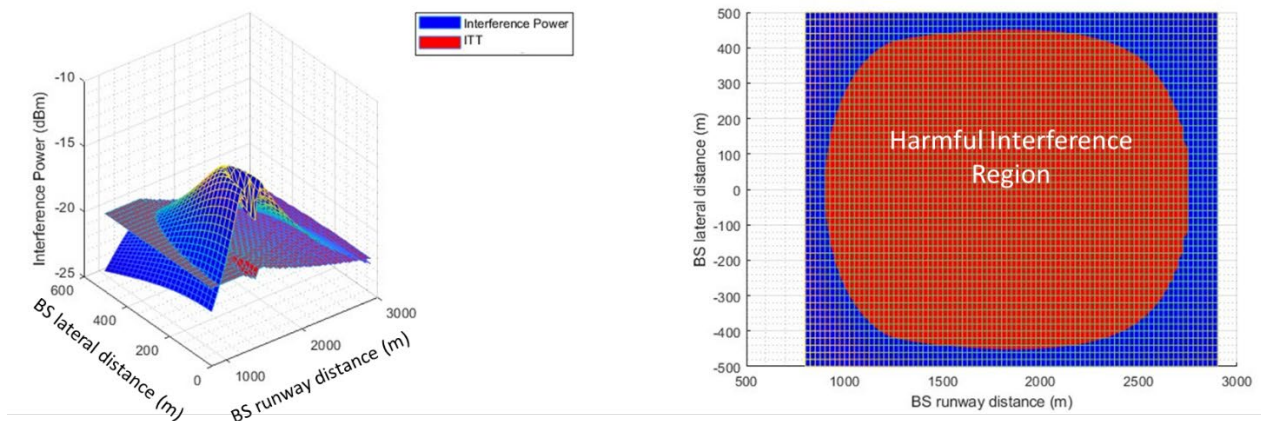

Figure 15: Interference power profile and harmful interference region for a Rural environment for an aircraft AGL between 200 feet and 1000 feet

For a fixed BS in-block power, the methodology described in section A3.4.4 for extracting the coordination region where the BS should not be placed is applied.

The region geometry is then simplified to a rectangular area whose edge is at distance $d_{critical} = 2.75\text{ km}$ from the TDP along the runway, and its half-height is given by $L_{critical} = 0.45\text{ km}$ for the lateral direction.

A3.5.2.2 Adjacent-band case – RA protection in 4200-4400 MHz

The spurious emissions of base stations do not cause harmful emissions when the aircraft is below 200 feet. As there are no safety margins for studies that are delimiting precautionary zones, and if the aircraft is at higher height than 200 feet, then RA are also protected in such case.

A3.5.3 Discussion of terrain profile impact on RA Interference

The conducted analysis showcased that harmful interference occurs both in the landing phase (aircraft below 200 feet) and preparation phase (aircraft between 200 feet and 1000 feet). For the case of perfectly flat terrain, the aggregated region of the xy plane in which a BS causes harmful interference is given in Figure 16.

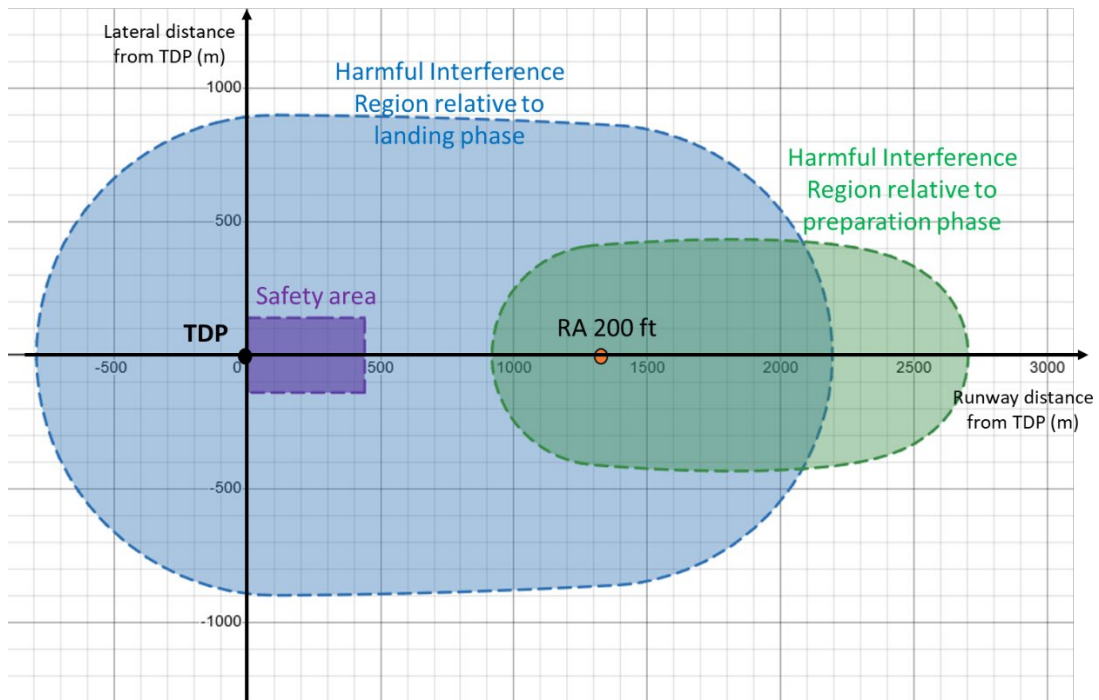

Figure 16: Interference regions for the landing phase and preparation phase with a BS in rural environment

While assuming flat terrain for the landing phase is sound due to the proximity with the landing area, this is not the case for the preparation phase which extends over large distances from the TDP (from 1330 m to 6650 m). In the presence of terrain height variations along the path of the aircraft to the TDP, the ITT of the aircraft changes according to the actual height above the ground level beneath the aircraft in each of its positions, moreover backscattering is also subject to change. The most problematic terrain profile scenario is when the aircraft flies over a valley with the BS placed outside of it. In this case, the actual tolerance threshold of the aircraft drops by many dBs compared to the flat terrain scenario, and thus the aircraft is much more susceptible to BS interference.

To illustrate that phenomenon, a simple terrain profile is shown in Figure 17 with the BS being placed at the top of the hill. The Corresponding ITT as a function of the RA runway distance are shown for this terrain in comparison with a flat terrain.

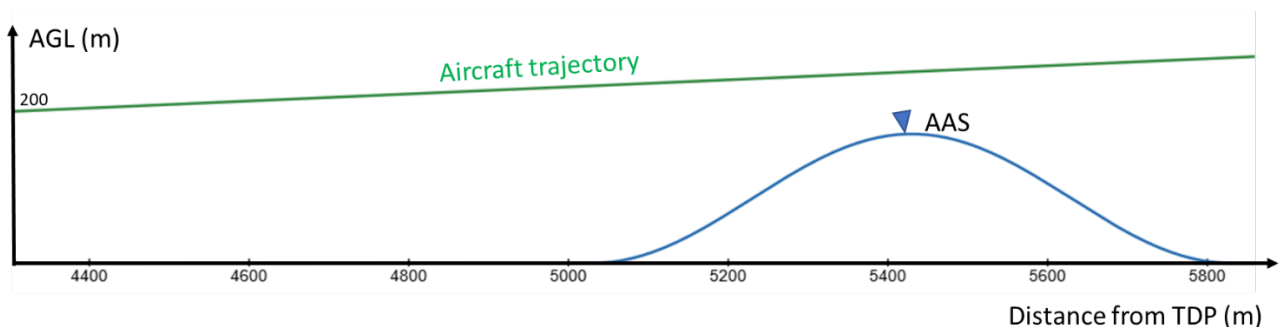

Figure 17: Example of a non-flat terrain profile along the aircraft trajectory

This results in the ITT profile of Figure 18 with respect to aircraft distance from TDP.

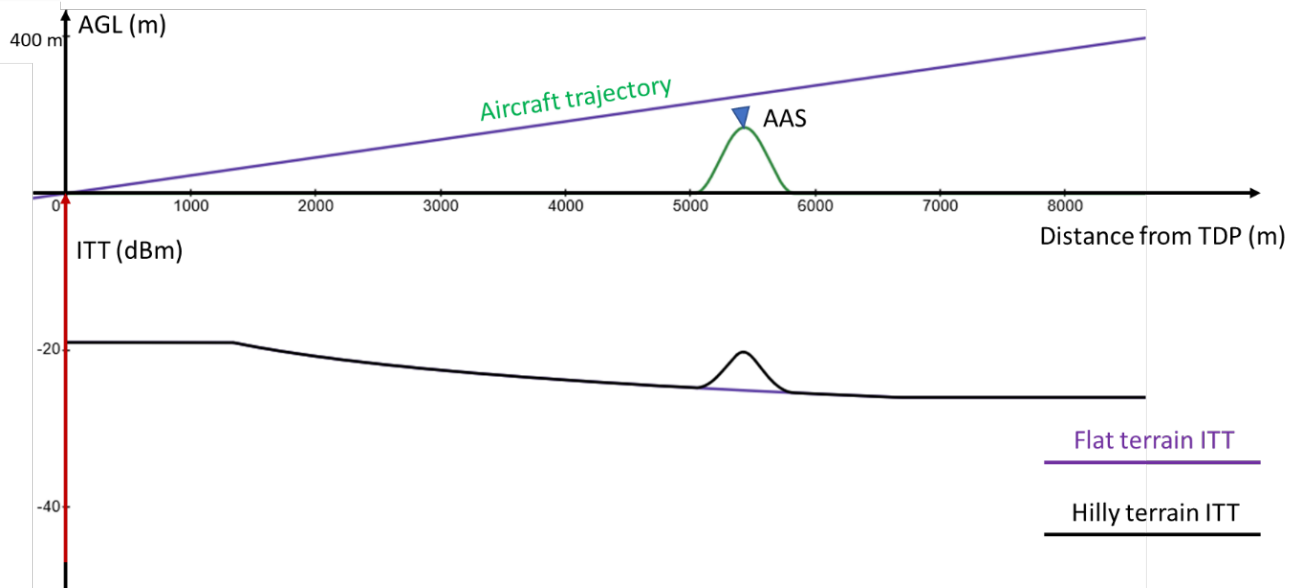

Figure 18: Schematic of the variations induced to ITT values with respect to a flat terrain assumption

According to flat terrain assumptions, there should be no issues in placing the BS around 5430 m from the TDP as it is well beyond the aggregated regions of Figure 19. Moreover, since the terrain profile increased ITT, one is to assume that there should be no problem as a net result. However, when investigating the interference caused by the BS AAS assuming:

- A mechanical downtilt of 6°;
- An elevation coverage range of 30°.

one can clearly observe aircraft flight sections which suffer from interference as shown in Figure 19. In other words, even when the terrain profile would enhance the tolerance of the RA with respect to the flat land scenario (at the same distance from TDP), harmful interference can still occur outside of the predicted regions.

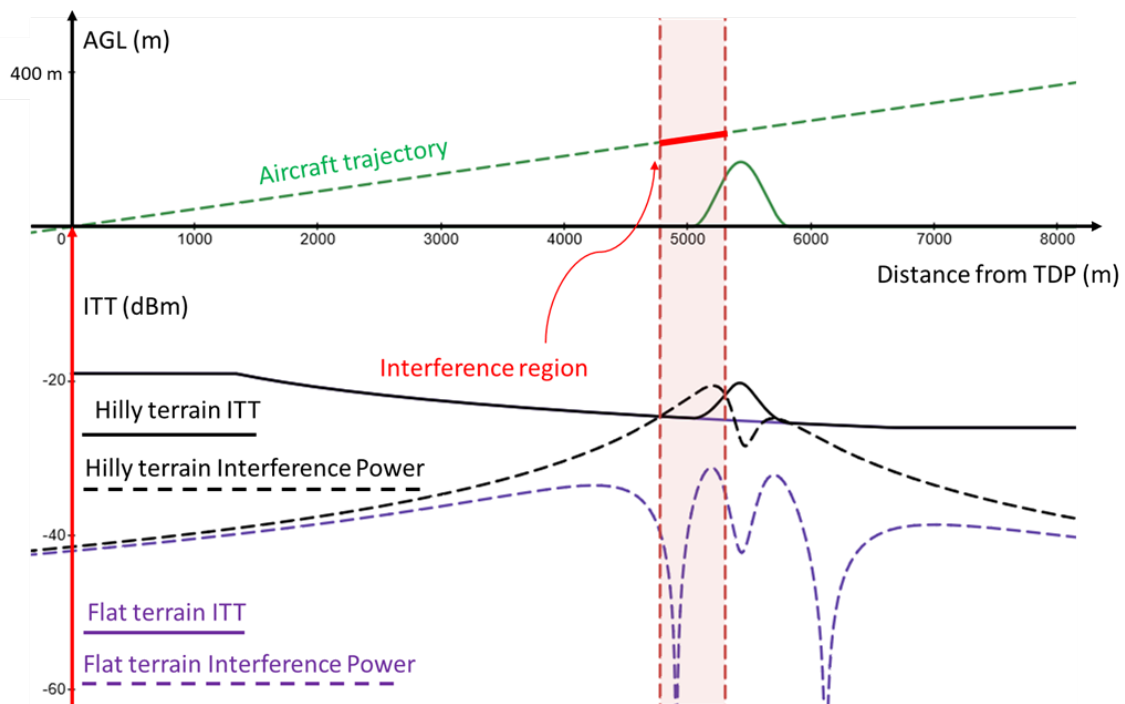

Figure 19: Example of problematic interference resulting from terrain profile variations

A3.5.3.1 Modelling terrain profile variations

Accounting for terrain profile variations and their impact on the interference prone region is necessary in order to identify potential harmful interference scenarios which would go unnoticed under flat terrain assumptions. To do so, the accurate terrain profile of every airport would be needed, and complex studies need to be undertaken. However, it is possible to bound the interference prone region by considering a near worst-case scenario where the ITT value is decreased when the aircraft passes on top of a valley with the BS being placed on top of the hill bordering it to efficiently serve terminals in the valley.

Using the flat terrain scenario as a basis for reasoning, when the aircraft passes over a valley, the BS distance to aircraft is not decreased maintaining the same interference level, however the corresponding ITT will be diminished due to the actual height above the ground of the RA. This effect can therefore be accounted for by taking an additional margin on ITT in flat terrain studies to assess the land region that is prone to cause interference. The bigger the difference in height between the (BS) elevation and the valley depth of a terrain profile, the bigger the margin should be to account for the terrain profile fluctuations. The near worst-case scenario is considered to be when the difference in heights adds up to 800 feet which would revert the ITT of 200 feet to that of ITT at 1000 feet. This corresponds to a 7 dB margin, Figure 20 shows the corresponding region when accounting for that margin.

To summarise, placing the BS in the green region can lead to an RA interference scenario depending on the terrain profile around the BS position. Therefore, a precautionary region should be defined where case by case assessment should be conducted depending on terrain data to exclude harmful interference from occurring at the level of the aircraft at any of its flight positions

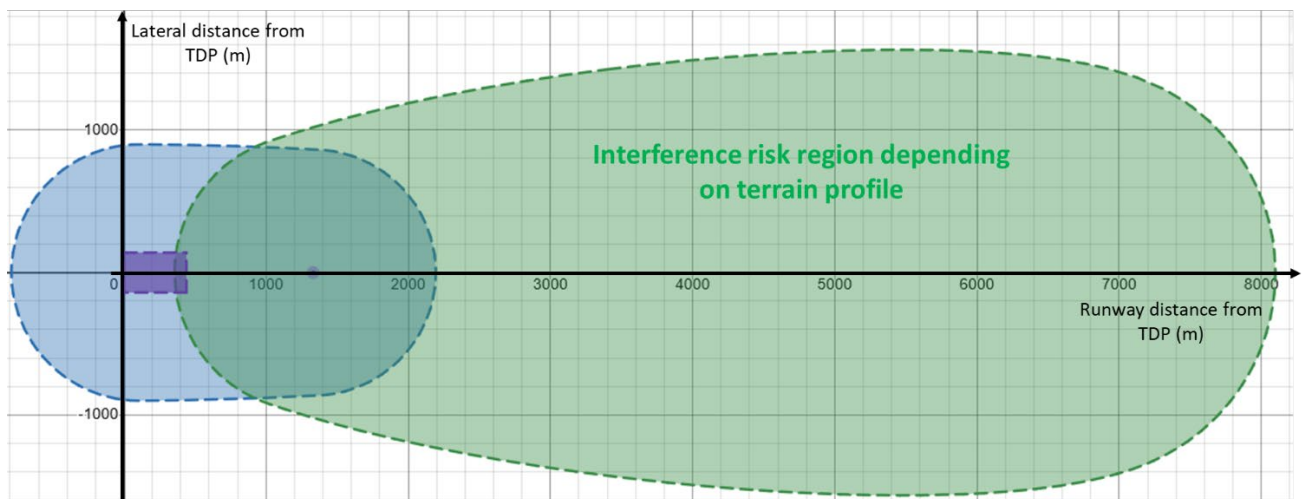

Figure 20: Interference Risk region accounting for terrain profile variations by a margin of 7 dB

A3.5.4 Conclusions

The results show that MFCN base stations (3400-3800 MHz) with 78 dBm *e.i.r.p.* cause harmful interference to Radio Altimeters independently of the AAS characteristics.

A3.5.4.1 Coordination zone: Flat terrain

The conducted study over a flat terrain showed that under the assumptions:

- *e.i.r.p.* is limited to 78 dBm/100 MHz;
- Antenna main beam not pointing above 0° horizon;
- Applying a 30° elevation coverage for the AAS;
- Applying the 6 dB ICAO safety margin from ground to 200 feet, and no safety margin from 200 feet to 1000 feet.

Harmful interference scenarios occur with negative margins up to -16 dB when the aircraft is below 200 feet, and -6.7 dB when the aircraft is between 200 feet and 1000 feet.

A coordination zone is then required, and coordination distances are defined in the results to yield a rectangular area of width 2800 m (rounded to the upper 100 m) from the TDP, runway axis, and half height of 940 m (distance perpendicular to the runway axis) if the base station *e.i.r.p.* is 78 dBm.

If the base station *e.i.r.p.* is lower than 78 dBm, then the coordination zone distances must be re-calculated in consequence following the methodology provided in section A3.4.3.

Consequently, radio altimeters are protected from MFCN base station (3400-3800 MHz) for:

- Base station located outside the coordination zone (see Figure 21) defined by a rectangle of width 2800 m, half-height 940 m.

Under the assumptions:

- Flat terrain near the landing area;
- *e.i.r.p.* is limited to 78 dBm/100 MHz;
- Antenna main beam not pointing above 0° horizon.

A3.5.4.2 Precautionary zone: Accounting for terrain height variations

The precautionary zone defines an area of interference risk region where placing the BS can potentially lead to a harmful interference scenario depending on the terrain profile near the landing area. Therefore, due to the uncertainty in the terrain profile and its large variability, a precautionary zone is defined, which covers the landing approach of the aircraft below 1000 feet (305 m). Through calculation, the precautionary zone is a rectangular area of width 5200 m, starting from a distance of 2800 m from the runway axis and with a half-height of 1600 m (lateral distance from the runway axis). In practice, experience feedback from civil aviation administrations since the beginning of 5G deployment showed that the half height distance can be reduced to 400 m.

Consequently, under the assumptions:

- *e.i.r.p.* is limited to 78 dBm/100 MHz;
- Antenna main beam not pointing above 0° horizon.

Then radio altimeter are protected from MFCN base station (3400-3800 MHz) interference while:

- MFCN base station are deployed outside the precautionary zone (see Figure 21) defined by a rectangle of width 5200 m, half-height 400 m;
- MFCN base station are deployed inside the precautionary zone with AAS grating lobe power level not harmful for Radio Altimeters.

A3.5.4.3 Summary

This section summarises the MFCN base station deployment conditions near the aircraft runway. The studies considered:

- *e.i.r.p.* is limited to 78 dBm.
- Antenna main beam not pointing above 0° horizon.
- BS height following OLS limitations.
- the same 200 feet ITT values is applied for the assessment of the interference from MFCN to the aircraft below 200 feet

Based on these assumptions, negative margins up to -10 dB are obtained with respect to the ITT (-16 dB including safety margin).

To mitigate harmful interference scenarios, two zones are defined to ensure Radio Altimeter protection, as shown in Figure 21:

- A coordination zone defined by a rectangle of width 2800 m, half-height 940 m, where the base station cannot be deployed if its transmitted power is not reduced below 78 dBm.
- A precautionary zone defined by a rectangle of width 5200 m, half-height 400 m, where the base can be deployed only if the AAS grating lobes do not cause harmful interference to Radio Altimeters. No safety margin is applied.

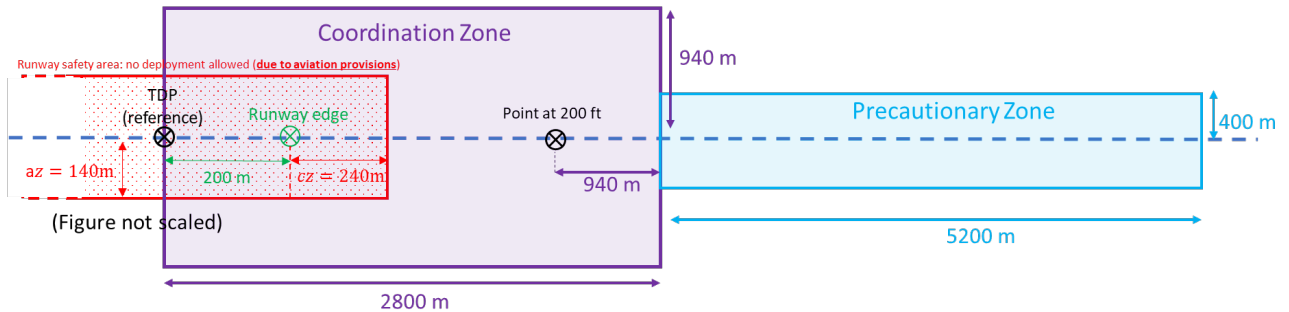

Figure 21: MFCN base station deployment conditions near the runway in the 3400-3800 MHz band

A3.6 RESULTS OF COMPATIBILITY STUDIES FOR WBB LMP BASE STATION (3800–4100 MHz)

A3.6.1 Aircraft below 200 feet

A3.6.1.1 In-band AAS case – RA protection in 3800-4100 MHz

Figure 22 shows the power margin (including the safety margin) for different base station deployment distance in the runway axis, for both 8x8 AAS and 4x4 AAS cases. The minimum power margin is 3.5 dB for the 8x8 AAS case and 1.4 dB for the 4x4 AAS case. As power margin are positives, RA are fully protected from harmful interference.

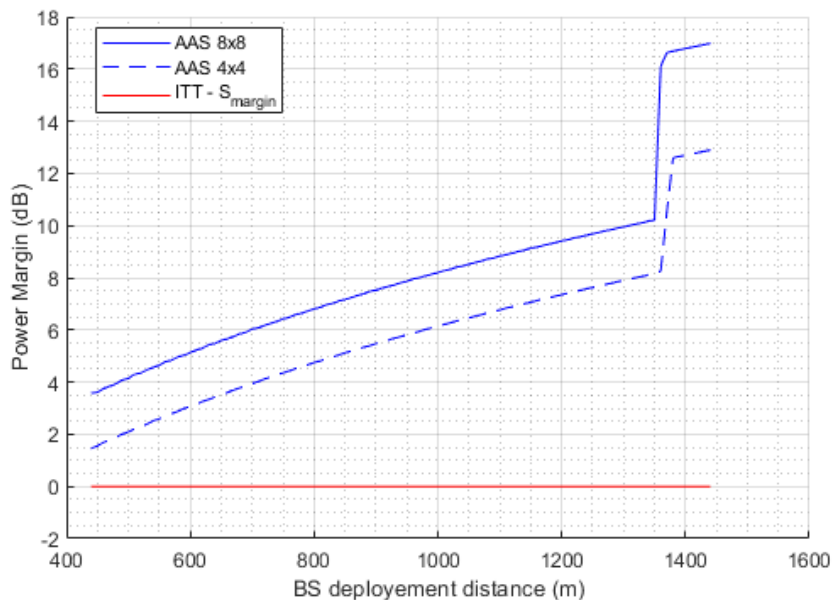

Figure 22: Power margin (dB) as a function of the BS deployment distance (m) within the runway axis, AAS 8x8 and 4x4 cases

It is however worth noting that the 4x4 AAS case presents lower power margin level than the 8x8 AAS cases. This can be explained by Figure 23 that shows the base station interfering power (dBm) as a function of the aircraft height, when the base station is deployed at distance = 1000 m from the TDP in the runway axis, as

an example. It can be observed that the highest interference power appears when the AAS elevation angle is higher than 50°, which corresponds to the AAS grating lobes.

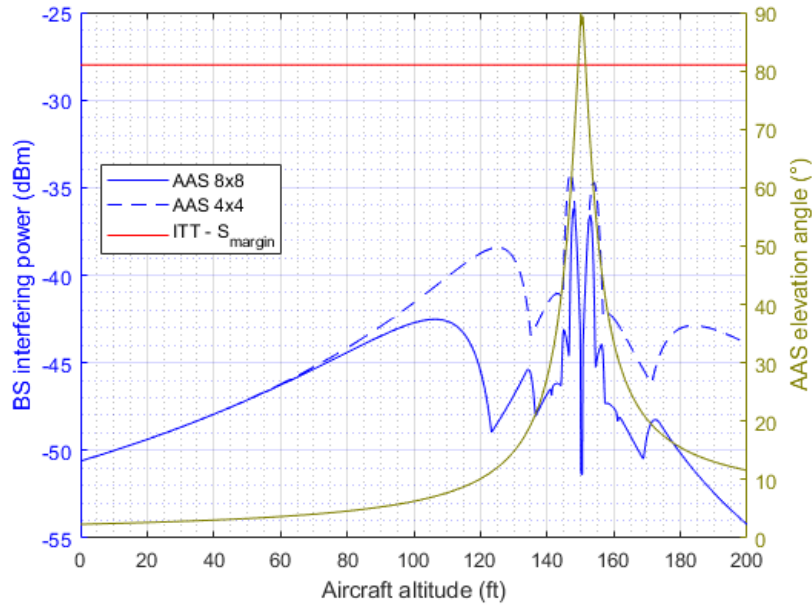

Figure 23: Base station interfering power (dBm) as a function of the aircraft height (feet) for a base station deployed at = 1000 m within the runway axis

It can be observed that the grating lobe power of the 4x4 AAS causes higher interference than the 8x8 AAS case, although the boresight gain is 6 dB lower. However, the TRP is increased by 6 dB for the 4x4 AAS case (compared to the 8x8 AAS case) to keep the transmitted power at 51 dBm. The difference in interfering power between both cases can then be explained by observing the radiation pattern envelope of each AAS, normalized to their respective maximum gain. It is clear from Figure 24 that the 4x4 AAS configuration has relatively higher grating lobes than the 8x8 AAS with respect to their maximum gain.

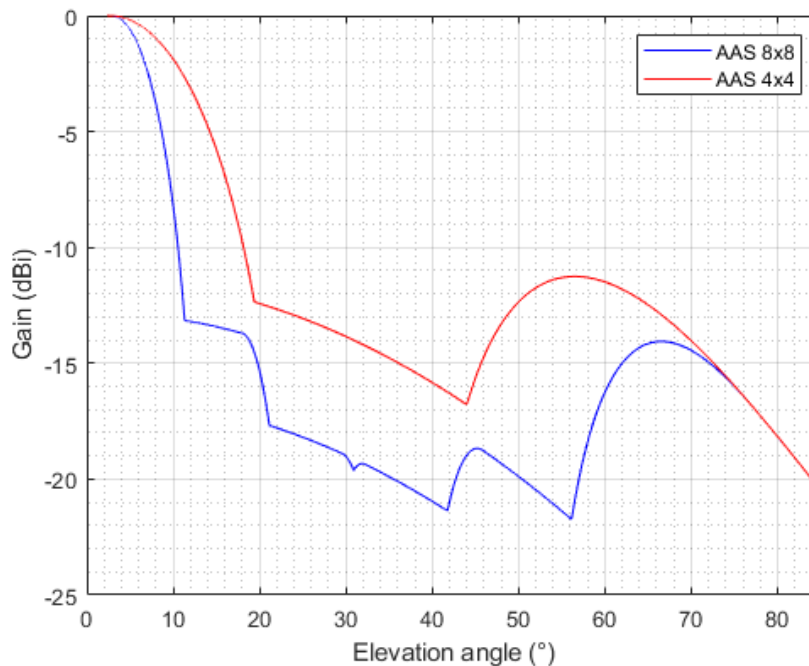

Figure 24: Normalised radiation pattern envelope for both 8x8 AAS and 4x4 cases

A3.6.1.2 Adjacent-band AAS case – RA protection in 4200-4400 MHz

For WBB LMP base stations emitting at carrier frequency $f = 4050$ (MHz), the parameter values for calculating security distance are:

- $ITT(f, 200 ft) = -76$ dBm/MHz (Parameter Set 2);
- $G_{RA}(f) = 10$ dBi (Parameter Set 2);
- $L_C = 3$ dB;
- $TRP_{BS} = -14$ dBm/MHz.

The maximum interfering power corresponds to the case where the aircraft is above the base station in the runway axis. This corresponds to a critical height of $\Delta H_{critical} = 0.014$ m. Due to OBZ limitation, the minimum height difference between the aircraft and the base station is $20m > \Delta H_{critical}$. Consequently, there are no situations where the base station spurious emissions cause harmful interference to Radio Altimeters.

A3.6.1.3 In-band non-AAS case – RA protection in 3800-4100 MHz

Figure 25 shows the power margin (including the safety margin) for different base station deployment distance in the runway axis. The minimum power margin being equal to 6.7 dB, RA are fully protected from harmful interference.

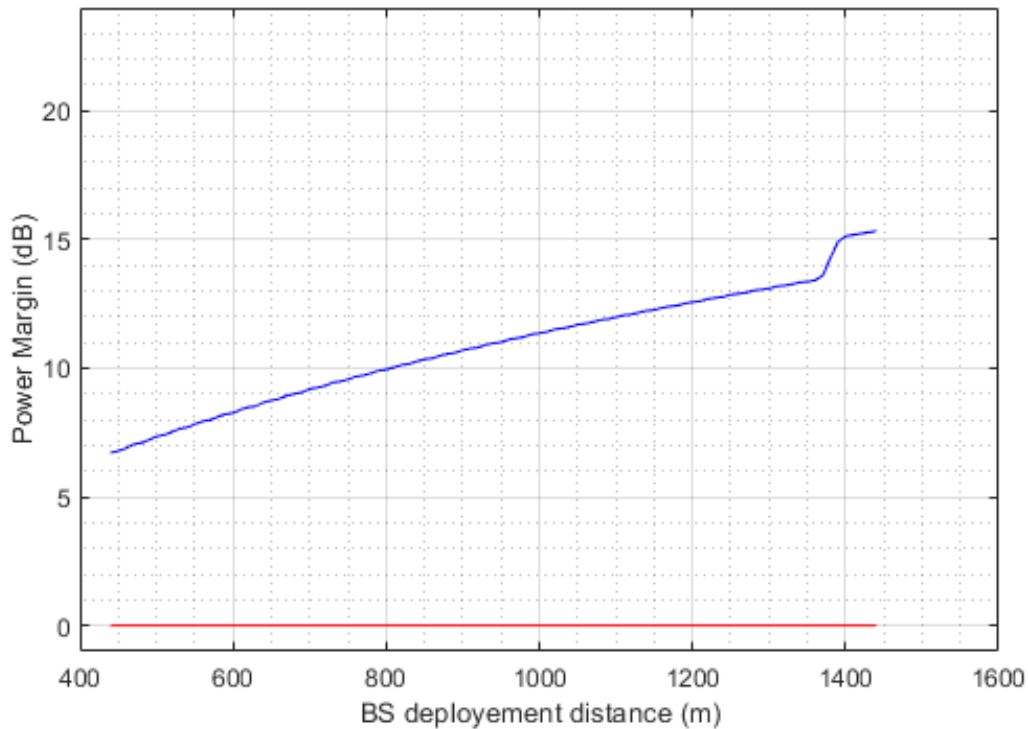

Figure 25: Power margin (dB) as a function of the BS deployment distance (m) within the runway axis, in-band non-AAS case

A3.6.1.4 Adjacent-band non-AAS case – RA protection in 4200-4400 MHz

Figure 26 shows the power margin (including the safety margin) for different base station deployment distance in the runway axis. The minimum power margin being equals to 12 dB, RA are fully protected from harmful interference.

A3.7 RESULTS OF COMPATIBILITY STUDIES FOR WBB LMP BASE STATION (4100-4200 MHZ)

A3.7.1 Aircraft below 200 feet

A3.7.1.1 In-band AAS case – RA protection in 4100-4200 MHz

Figure 31 shows the power margin (including the safety margin) for different base station deployment distances on the runway axis (D_{BS}) and lateral axis (L_{BS}), for both 8x8 AAS and 4x4 AAS cases. The minimum power margin is 2.5 dB for the 8x8 AAS case and 0.9 dB for the 4x4 AAS case. As power margin are positives, RA are fully protected from harmful interference if the *e.i.r.p.* limit is fixed to 51 dBm.

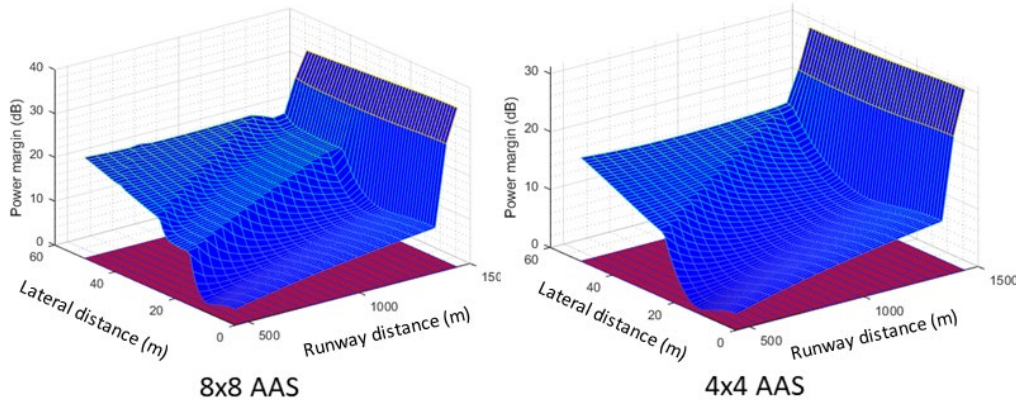

Figure 26: Power margin (dB) as a function of the BS deployment distance (m) along the runway axis D_{BS} and lateral axis L_{BS} for 8x8 AAS and 4x4 AAS cases

It is however worth noting that the 4x4 AAS case presents lower power margin level than the 8x8 AAS cases. This can be explained by Figure 32 that shows the base station interfering power (dBm) as a function of the aircraft height when the base station is deployed at distance $D_{BS} = 1000$ m from the TDP on the runway axis and $L_{BS} = 30$ m in the lateral direction, as an example. It can be observed that the highest interference power appears when the AAS elevation angle is at 50° , which corresponds to the angle where the 4x4 AAS main grating lobe is located.

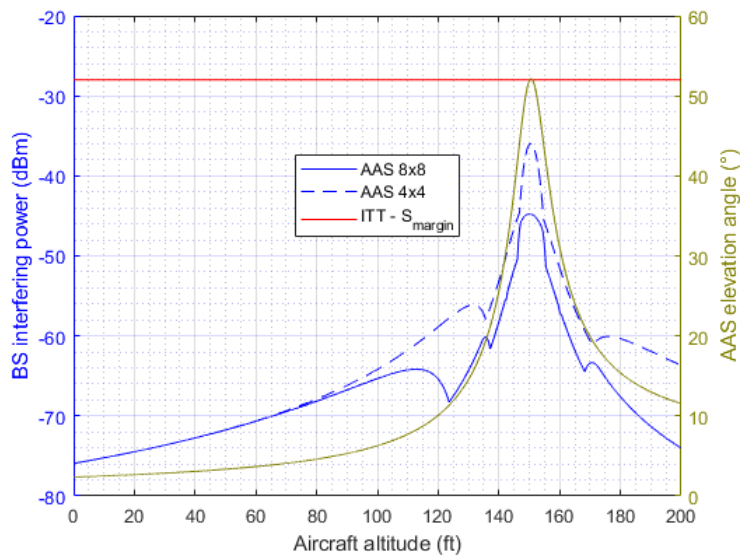

Figure 27: Base station interfering power (dBm) as a function of the aircraft height (feet) for a base station deployed at $D_{BS} = 1000$ m $L_{BS} = 30$ m

A3.7.1.2 Adjacent-band AAS case – RA protection in 4200-4400 MHz

The methodology for deriving the deployment distance limitation takes into account the classes of out-of-band emissions in the 4200-4400 MHz.

The out-of-band emissions in the 4200-4240 MHz bands (see Table 27) must be taken into consideration when calculating the interference power. In addition, the AAS radiation pattern is omni-directional only for a portion of the 200 MHz band. Not considering the antenna gain as a first step, the unwanted emission power is:

$$ITT = BP - BTI_f - EE_f - U&T_f$$

Equation 22

The above equation can be equivalently rewritten by factorizing each P_OOB terms relatively to P_spur in a more compact form as:

$$EIRP_{max}(f) = P_{spur} + 23 + 10 \log_{10} \left(\sum_{k=1}^3 C_k \right),$$

Equation 23

Where C_k are coefficients obtained through the equations in Table 27. To consider the antenna gains in the above formula, coefficients α_k taking values between 0 and 1, indicate at which percent of the OOB/spurious bandwidth the AAS radiation pattern model in Table 22 must be applied. Equation 24 presents the equations for the α_k coefficients, as a function the frequency offset $[\Delta F_{(AAS,spur)}$ where the AAS acts as an omni-directional antenna. The final equation for the base station unwanted emission is

$$EIRP_{max}(\theta_{AAS \rightarrow RA}, f) = P_{spur} + 23 + \log_{10} \sum_{k=1}^3 \left(C_k \left(10^{\frac{G_{AAS}(\theta_{AAS \rightarrow RA})}{10}} \alpha_k + 10^{\frac{G_{AAS,spur}}{10}} (1 - \alpha_k) \right) \right)$$

Equation 24

Table 27: Coefficients for calculating the unwanted emission

C_k	α_k
$C_1 = \frac{1}{40} 10^{\frac{P_{OOB1} - P_{spur}}{10}}$	$\alpha_1 = \min \left(\max \left(\frac{\Delta F_{AAS,spur}}{5}, 0 \right), 1 \right)$
$C_2 = \frac{7}{40} 10^{\frac{P_{OOB2} - P_{spur}}{10}}$	$\alpha_2 = \min \left(\max \left(\frac{\Delta F_{AAS,spur} - 5}{35}, 0 \right), 1 \right)$
$C_3 = \frac{4}{5}$	$\alpha_3 = \min \left(\max \left(\frac{\Delta F_{AAS,spur} - 40}{160}, 0 \right), 1 \right)$

Deriving the base station deployment distance limitations, Figure 33 a) shows the power margin (including the safety margin) for different base station deployment distances on the runway axis () and lateral axis (), for the 8x8 AAS case. The minimum power margin is -4.5 dB, so a coordination zone has to be defined to protect the RA from harmful interference if the transmitted power is 51 dBm. The runway coordination distance (along the runway axis) can be inferred from Figure 33 c) by finding the runway distance where the minimum power margin taken from all the lateral positions (at that runway distance) crosses the 0-dB threshold. The lateral coordination distance (along the lateral axis) can be inferred from Figure 33 d) by finding the lateral distance where the minimum power margin from all the positions on the runway axis (at that lateral distance) cross the 0-dB threshold. From these figures, the coordination distances are as follows: = 990 m and = 18 m.

The same analysis is applied for the 4x4 AAS case, shown in Figure 34. The minimum power margin is -3.3 dB, and a coordination zone of = 790 m and = 20 m has to be defined to protect the RA from harmful interference if the transmitted power is 51 dBm.

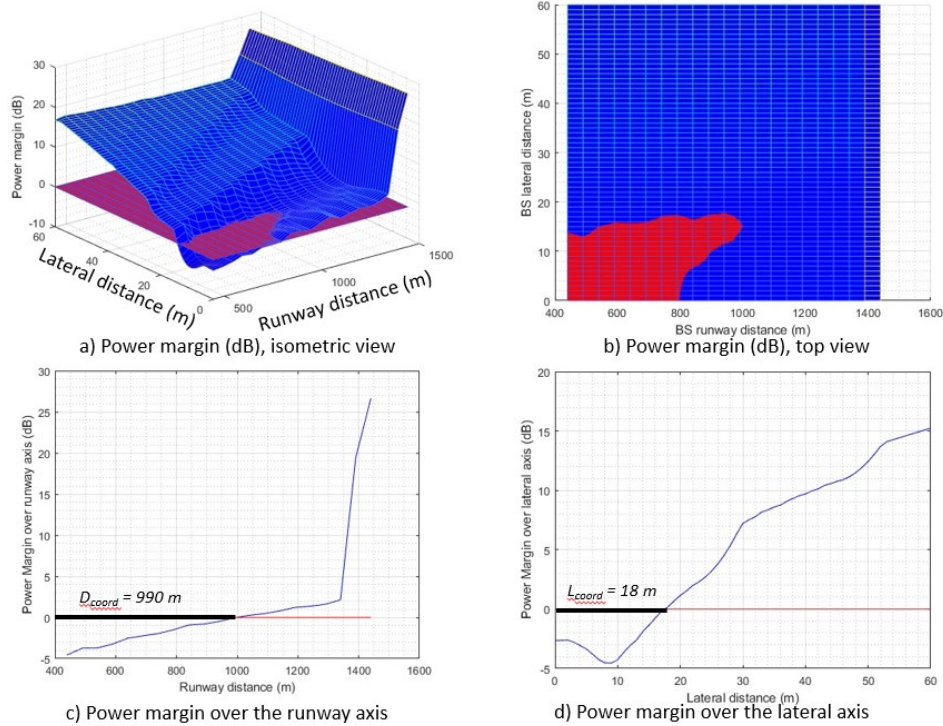

Figure 28: Power margin (dB) as a function of the BS deployment distance (m) along the runway axis and lateral axis for 8x8 AAS

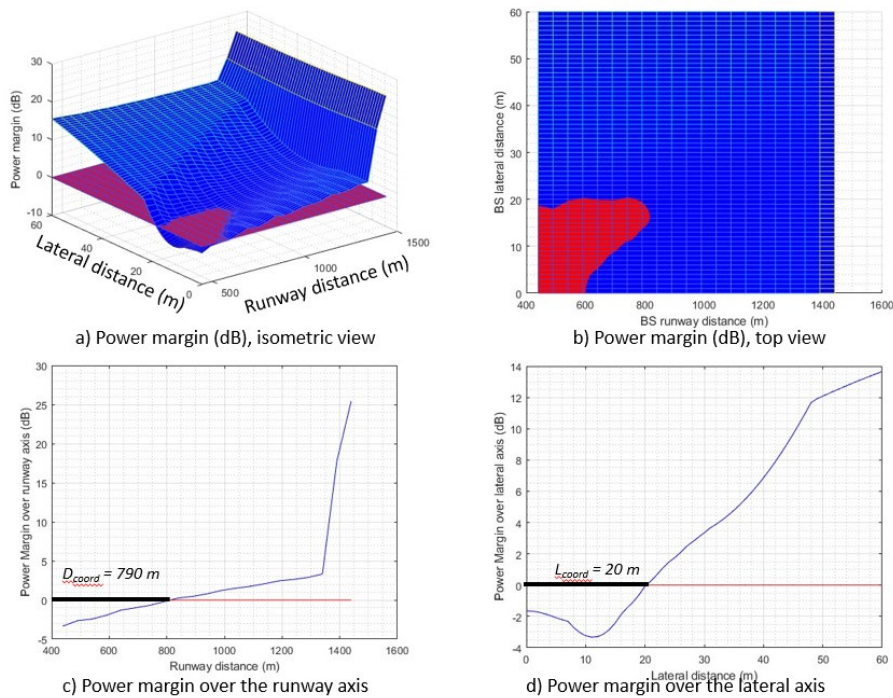

Figure 29: Power margin (dB) as a function of the BS deployment distance (m) along the runway axis and lateral axis for 4x4 AAS

Table 26 provides for a given base station minimum height, the corresponding minimum runway and lateral distances to abide by the OLS restriction. The minimum BS height results thus in minimum allowed BS distances from the TDP (both in the runway and lateral directions) which affect the power margin which is therefore reported in Table 26 for both 4x4 and 8x8 AAS. There it can be seen that for a BS minimum height of 6 m, only -0.7 dB of power margin is obtained for 4x4 AAS versus -2 dB for the 8x8 AAS case. For BS height between 15 and 20 m there is a large margin increase (by more than 20 dB) due to the particular geometries involved.

Table 28: Impact of the base station minimum height on the power margin for AAS 4x4 and 8x8 with BEM from ECC Decision (11)06 [10]

Base station minimum height (m)	Minimum power margin (dB) AAS 4x4	Minimum power margin (dB) AAS 8x8	Minimum runway distance in accordance with OLS (m)	Minimum lateral distance in accordance with OLS (m)
0	-3.3	-4.55	440	140
6	-0.7	-2	740	182
10	0.8	-0.5	940	210
15	2.46	1.2	1190	245
20	25.5	26.6	1440	280

Finally, Table 29 shows the impact of the base station *e.i.r.p.* on the coordination distance for the 8x8 AAS case (for a minimum BS height of 0 m).

Table 29: Impact of the base station *e.i.r.p.* on the coordination distances (8x8 AAS case)

Base station <i>e.i.r.p.</i> (dBm)	Minimum power margin (dB)	D_{coord} (m)	L_{coord} (m)
49	-4	940	16
50	-4.2	940	17
51	-4.5	990	18
52	-4.9	1040	18
53	-5.3	1140	19

Additionally, the adjustment of the previous BEM to fully cover the 6dB ICAO safety margin for all configurations including 4x4 and 8x8 AAS equipped medium power WBB LMP AAS for all BS heights down to the ground was also assessed (see Table 30 for resulting BEM).

Table 30: Power limit based on ECC Decision (11)06 [10], to be applied above 4200 MHz for AAS WBB LMP base stations to avoid the need for imposing national measures for the protection of Radio Altimeters

Frequency range (MHz)	Notation	AAS TRP limit in dBm/MHz per cell (Note 1)	AAS TRP limit in dBm/MHz per cell (Note 1) applied for 4x4 AAS	AAS TRP limit in dBm/MHz per cell (Note 1) applied for 8x8 AAS
4200-4205	P_{OOB1} (dBm/MHz)	TRP – 47 (Note 2)	-14.4	-20.4
4205-4240	P_{OOB2} (dBm/MHz)	TRP – 52 (Note 2)	-19.4	-25.4
Above 4240	P_{OOB3} (dBm/MHz)	-30	-30	-30

Note 1: In a multi-sector base station, the radiated power limit applies to each one of the individual sectors

A3.7.1.3 Additional analysis with BEMs derived from ETSI on adjacent band interference on Radio Altimeters in 4200-4400 MHz for the AAS case

In the section above the BEM applied to medium power WBB LMP emissions in the band 4100-4200 MHz was extended from the ECC Decision (11)06 [10] for emissions in the out of band of 3400-3800 MHz. In this section the results of the interference from AAS 4x4 (without sub-arrays) and AAS 8x8 (without sub-arrays) are re-evaluated when considering the BEM from ETSI (TS 138 104 V17.11.0 (2023-10, section 9.7.4 and table 6.6.4.2.3-2 [36]) and a variant of it, with a spurious emission of -30 dBm/MHz in alignment with ERC Recommendation 74-01 [4]. Table 31 provides the unwanted emissions BEM derived from ETSI.

Table 31: Baseline requirement for BS above 4.2 GHz according to ETSI TS 138 104 Section 9.7.4

Frequency range	AAS MP BS TRP. limit dBm/5 MHz per cell (Note 1)
4200-4205 MHz	1
4205-4210 MHz	-3
4210-4240 MHz	-3
Above 4240 MHz	-23

Note 1: In a multi-sector site, the value per 'cell' corresponds to the value for one of the sectors.

Deriving the base station deployment distance limitations, Figure 35 a) shows the power margin (including the safety margin) for different base station deployment distances on the runway axis (D_{BS}) and lateral axis (L_{BS}), for the 8x8 AAS case. The minimum power margin is -13.5 dB, so a coordination zone has to be defined to protect the Radio Altimeter from harmful interference if the transmitted power is 51 dBm. The runway coordination distance D_{coord} (along the runway axis) can be inferred from Figure 35 c) by finding the runway distance where the minimum power margin taken from all the lateral positions (at that runway distance) crosses the 0-dB threshold. The lateral coordination distance L_{coord} (along the lateral axis) can be inferred from Figure 35 d) by finding the lateral distance where the minimum power margin from all the positions on the runway axis (at that lateral distance) cross the 0-dB threshold. From these figures, the coordination distances are as follows: $D_{coord} = 1340$ m and $L_{coord} = 32$ m.

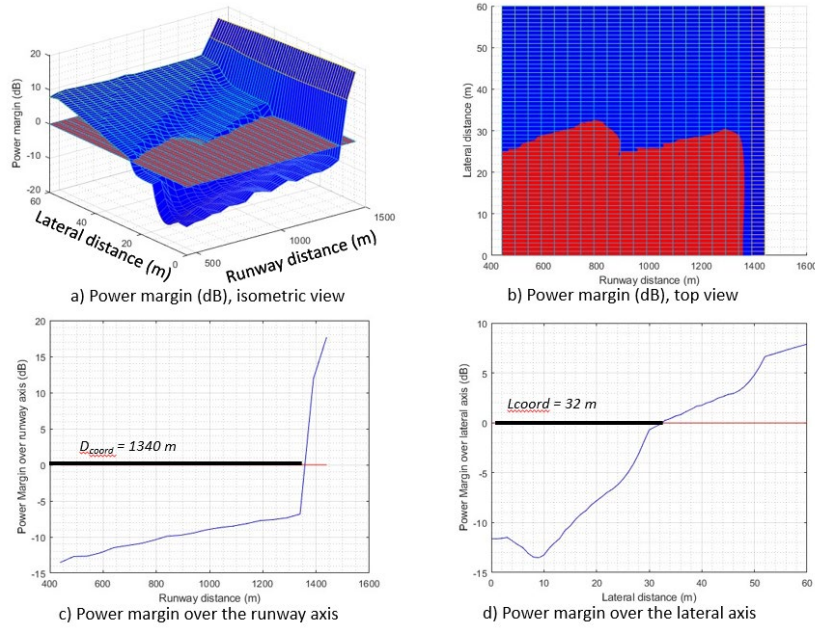

Figure 30: Power margin (dB) as a function of the BS deployment distance (m) along the runway axis D_{BS} and lateral axis L_{BS} for 8x8 AAS for BEM derived from ETSI TS 138 104, section 9.7.4

The same analysis is applied for the 4x4 AAS case, shown in Figure 36. The minimum power margin is -8.9 dB, and a coordination zone of $D_{coord} = 1340$ m and $L_{coord} = 37$ m has to be defined to protect the Radio Altimeter from harmful interference if the transmitted power is 51 dBm.

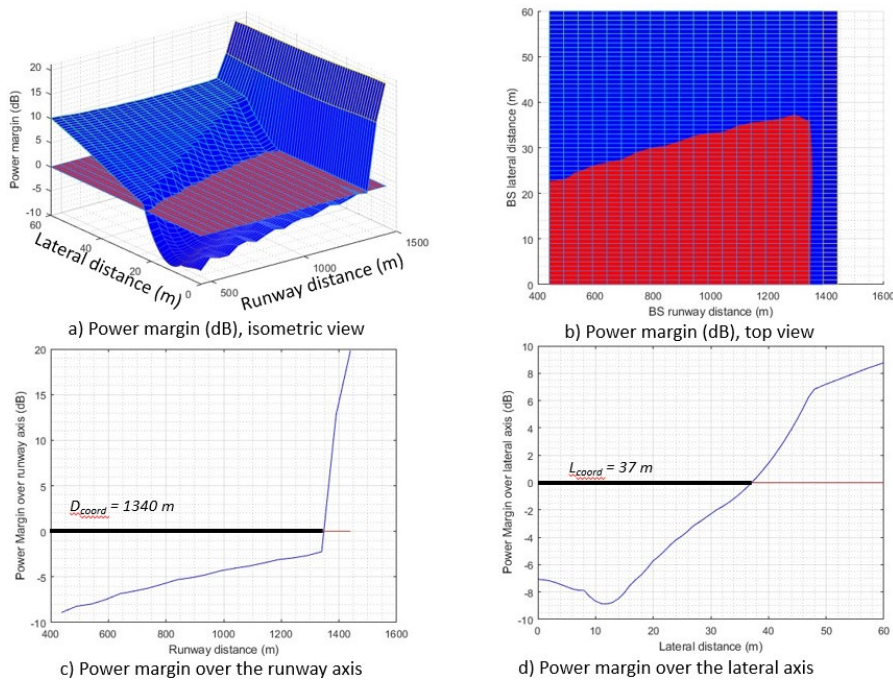

Figure 31: Power margin (dB) as a function of the BS deployment distance (m) along the runway axis D_{BS} and lateral axis L_{BS} for 4x4 AAS for BEM derived from ETSI TS 138 104, section 9.7.4

Table 32 provides for a given base station minimum height the corresponding minimum runway and lateral distances to abide by the OLS restriction, together with corresponding power margin. There, it can be seen that the BEM derived from ETSI would still induce significantly negative power margins for WBB LMP minimum BS height of 6 m, even for 4x4 AAS, with a value of -4.7 dB compared to the -0.2 dB for the BEM based on ECC decision (11)06. Therefore, the OLS region alone cannot be relied on to ensure the protection of Radio

Altimeters from WBB LMP medium power AS adjacent band interferences when adopting the BEM derived from ETSI, inducing thereby the need for regulatory measures to enable the protection of Radio Altimeters.

It should be noted that when assessing the adjacent band interference from WBB LMP on the Radio Altimeter in-band, the exact same results are obtained for Parameter Set 1 with the least resilient Radio Altimeter model.

Table 32: Impact of the base station minimum height on the power margin for AAS 4x4 and 8x8 with BEM derived from ETSI TS 138 104 section 9.7.4

Base station minimum height (m)	Minimum power margin (dB) AAS 4x4	Minimum power margin (dB) AAS 8x8	Minimum runway distance in accordance with OLS (m)	Minimum lateral distance in accordance with OLS (m)
0	-8.9	-13.5	440	140
6	-6.2	-10.9	740	182
10	-4.7	-9.4	940	210
15	-3.1	-7.7	1190	245
20	19.8	17.7	1440	280

The simulations were re-run with a BEM reduced compared to the BEM derived from the Spectrum Emission Mask in ETSI TS 138 104 [38] by various different dB values and, for AAS 4x4, the 6 dB reduced BEM ensured to nearly fulfil the Radio Altimeter threshold with the 6 dB ICAO safety margin with a BS height higher than 6 m (a margin of -0.4 dB at 6 m BS height is assumed to be acceptable) and is presented in the table below. The interference results of such a BEM are presented in Table 37.

Table 33: Baseline requirement for BS above 4.2 GHz according to the 6 dB reduced BEM

Frequency range	AAS MP BS TRP. limit dBm/5 MHz per cell (Note 1)
4200-4205 MHz	-5
4205-4210 MHz	-9
4210-4240 MHz	-9
Above 4240 MHz	-23
Note 1: In a multi-sector site, the value per 'cell' corresponds to the value for one of the sectors.	

Deriving the base station deployment distance limitations, Figure 37a) shows the power margin (including the safety margin) for different base station deployment distances on the runway axis (D_{BS}) and lateral axis (L_{BS}), for the 8x8 AAS case. The minimum power margin is -7.7 dB, so a coordination zone has to be defined to protect the Radio Altimeter from harmful interference if the transmitted power is 51 dBm. The runway coordination distance D_{coord} (along the runway axis) can be inferred from Figure 37 by finding the runway distance where the minimum power margin taken from all the lateral positions (at that runway distance) crosses the 0-dB threshold. The lateral coordination distance L_{coord} (along the lateral axis) can be inferred from Figure 37d) by finding the lateral distance where the minimum power margin from all the positions on the runway axis (at that lateral distance) cross the 0-dB threshold. From these figures, the coordination distances are as follows: $D_{coord} = 1340$ m and $L_{coord} = 25$ m.

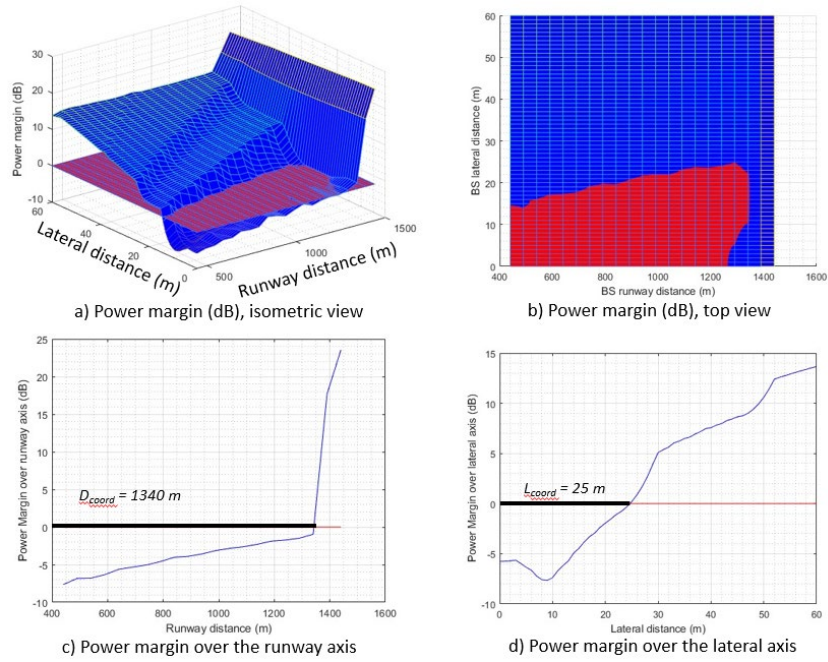

Figure 32: Power margin (dB) as a function of the BS deployment distance (m) along the runway axis D_{BS} and lateral axis L_{BS} for 8x8 AAS for BEM derived from ETSI TS 138 104 section 9.7.4 reduced by 6 dB

The same analysis is applied for the 4x4 AAS case, shown in Figure 38. The minimum power margin is -3 dB, and a coordination zone of $D_{coord} = 790$ m and $L_{coord} = 20$ m has to be defined to protect the RA from harmful interference if the transmitted power is 51 dBm

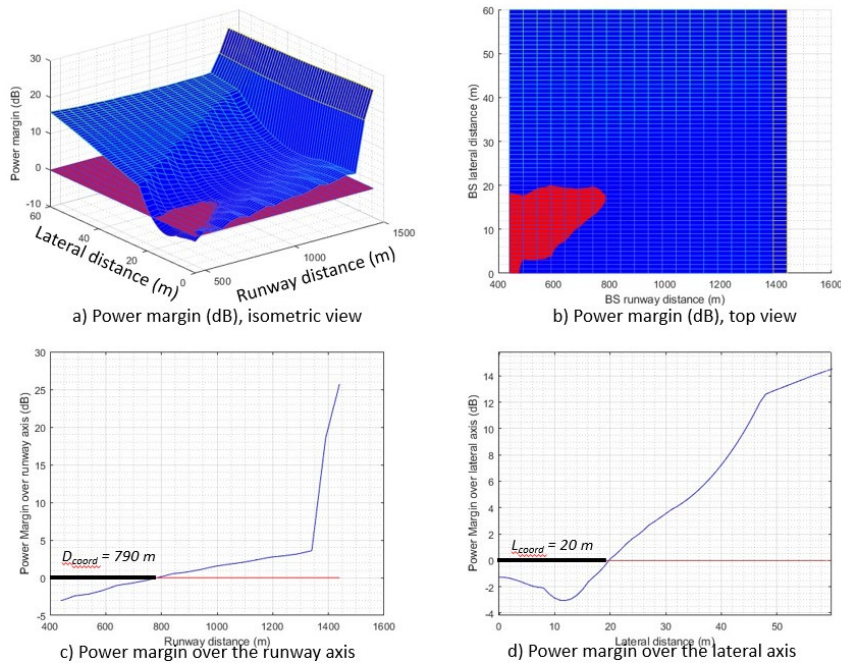

Figure 33: Power margin (dB) as a function of the BS deployment distance (m) along the runway axis D_{BS} and lateral axis L_{BS} for 4x4 AAS for BEM derived from ETSI TS 138 104 section 9.7.4 reduced by 6 dB

Table 38 provides for a given base station minimum height the corresponding minimum runway and lateral distances to abide by the OLS restriction, together with corresponding power margin.

There, it can be seen that for AAS 4x4, the BEM derived from ETSI with 6 dB reduction (more constraining) ensures to nearly fulfil the Radio Altimeter threshold with the 6 dB ICAO safety margin with a BS height higher than 6 m (a margin of -0.4 dB at 6 m BS height is observed).

However, the case of AAS 8x8 would lead to a significant negative margin (relative to threshold with the 6 dB ICAO safety margin), even for BS height higher than 6 m.

Table 34: Impact of the base station minimum height on the power margin for AAS 4x4 and 8x8 with BEM derived from ETSI TS 138 104 section 9.7.4 reduced by 6 dB

Base station minimum height (m)	Minimum power margin (dB) AAS 4x4	Minimum power margin (dB) AAS 8x8	Minimum runway distance in accordance with OLS (m)	Minimum lateral distance in accordance with OLS (m)
0	-3	-7.7	440	140
6	-0.4	-5	740	182
10	1.1	-3.6	940	210
15	2.7	-1.9	1190	245
20	25.7	24	1440	280

A3.7.1.4 In-band non-AAS case – RA protection in 4100-4200 MHz

Figure 39 shows the power margin (including the safety margin) for different base station deployment distances on the runway axis (D_{BS}) and lateral axis (L_{BS}). The minimum power margin being equal to 6.6 dB, RA are fully protected from harmful interference.

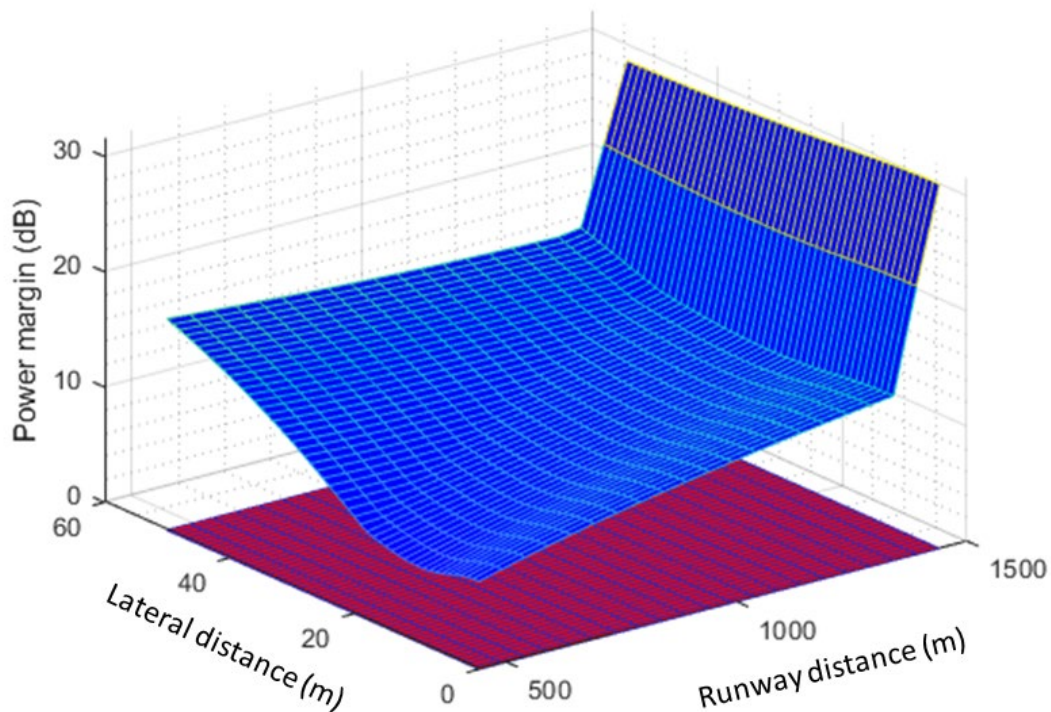

Figure 34: Power margin (dB) as a function of the BS deployment distance (m) along the runway axis D_{BS} and lateral axis L_{BS} for In-band non-AAS

A3.7.1.5 Adjacent-band non-AAS case – RA protection in 4100-4200 MHz

Based on the methodology presented in section A3.4.2 for deriving the power margin for every base station position, Figure 40 shows the power margin (including the safety margin) for different base station deployment distances on the runway axis (D_{BS}) and lateral axis (L_{BS}). The minimum power margin being equal to 6 dB, RA are fully protected from harmful interference.

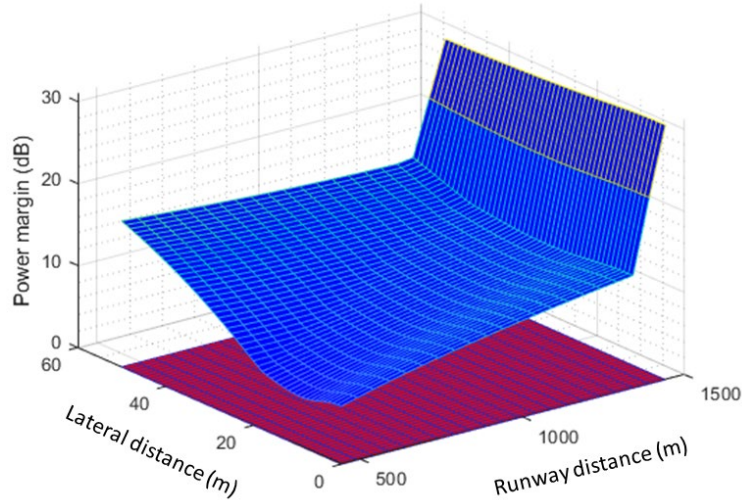

Figure 35: Power margin (dB) as a function of the BS deployment distance (m) along the runway axis D_{BS} and lateral axis L_{BS} for Adjacent-band non-AAS

A3.7.2 Aircraft between 200 feet and 1000 feet

A3.7.2.1 In-band AAS case – RA protection in 4100-4200 MHz

Figure 41 and Figure 42 show the power margin for different base station deployment distances on the runway axis (D_{BS}) and lateral axis (L_{BS}) when respectively considering 8x8 and 4x4 AAS. The minimum power margins being respectively equal to 16.2 dB (8x8 AAS) and 15.4 dB (4x4 AAS), RA are fully protected from harmful interference.

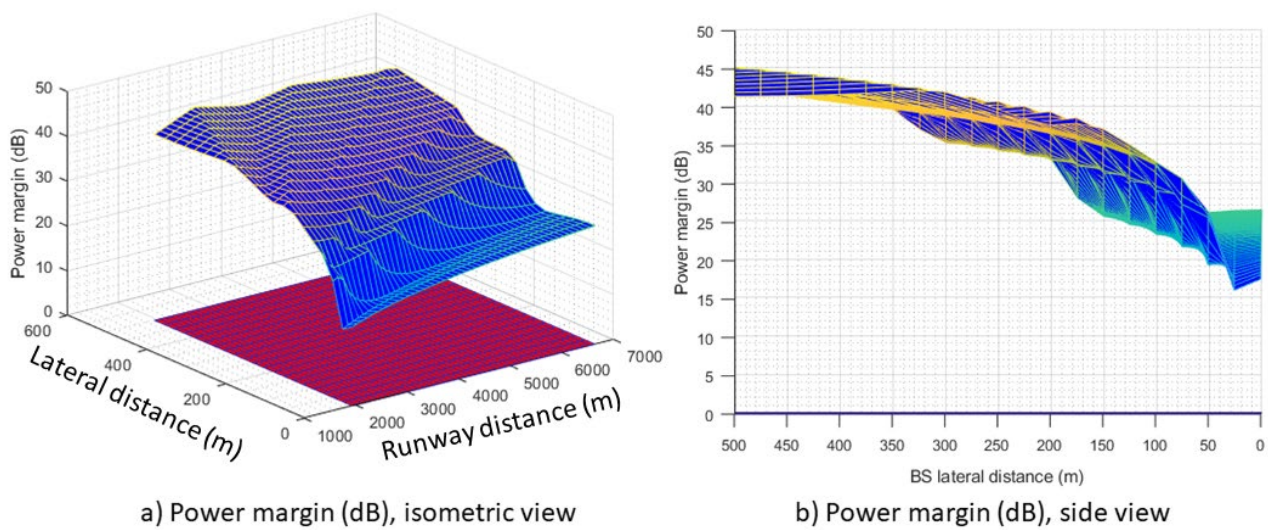

Figure 36: Power margin (dB) as a function of the BS deployment distance (m) along the runway axis D_{BS} and lateral axis L_{BS} for 8x8 AAS (in-band case)

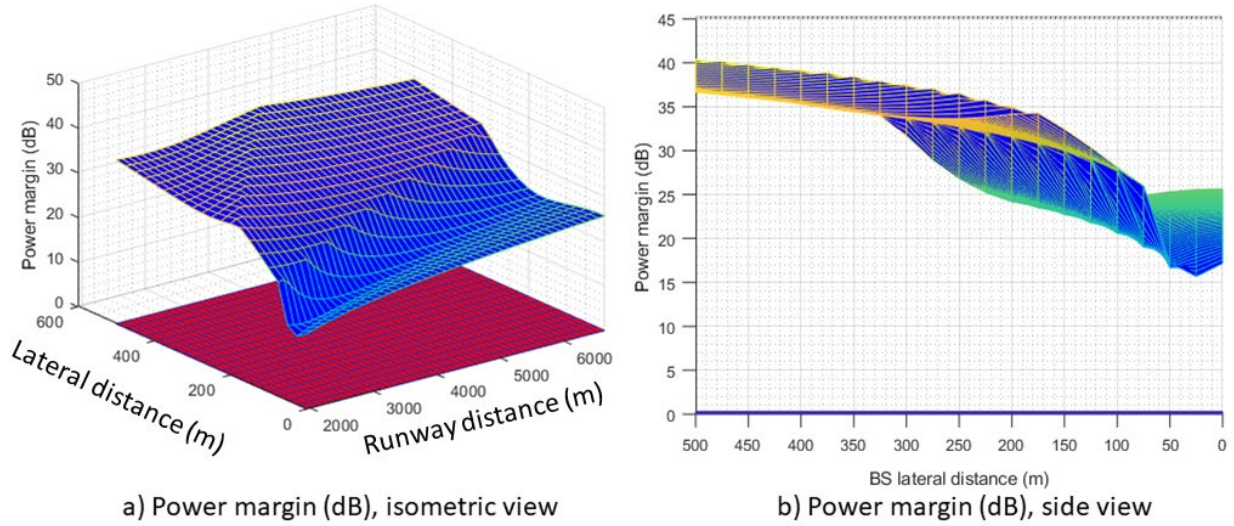

Figure 37: Power margin (dB) as a function of the BS deployment distance (m) along the runway axis D_{BS} and lateral axis L_{BS} for 4x4 AAS (in-band case)

A3.7.2.2 Adjacent-band AAS case – RA protection in 4200-4400 MHz

Figure 43 and Figure 44 show the power margin for different base station deployment distances on the runway axis (D_{BS}) and lateral axis (L_{BS}) when respectively considering 8x8 and 4x4 AAS. The minimum power margins being respectively equal to 11.4 dB (8x8 AAS) and 13.1 dB (4x4 AAS), RA are fully protected from harmful interference.

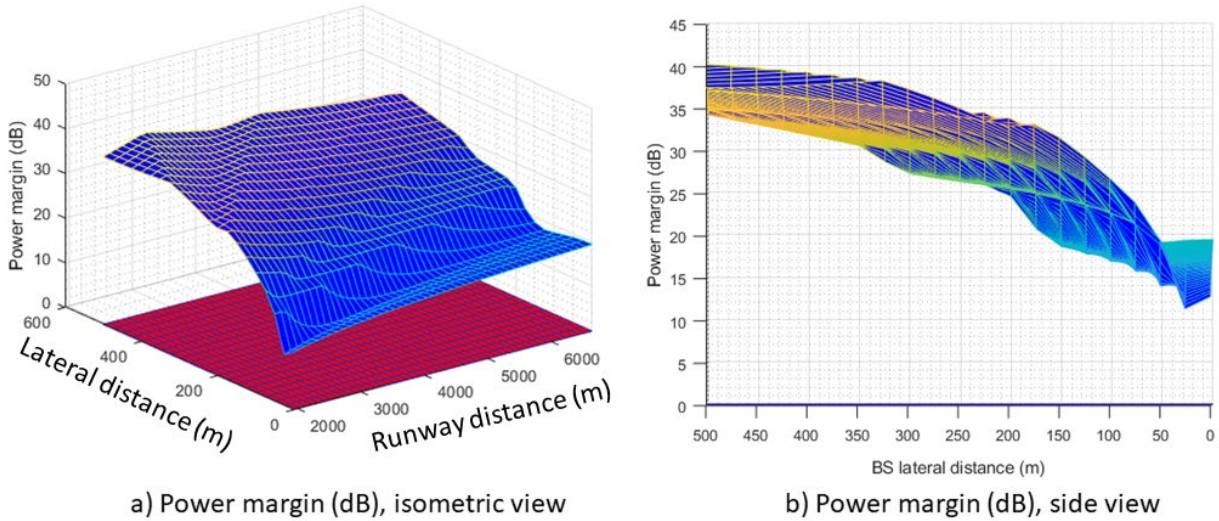

Figure 38: Power margin (dB) as a function of the BS deployment distance (m) along the runway axis D_{BS} and lateral axis L_{BS} for 8x8 AAS (adjacent-band case)

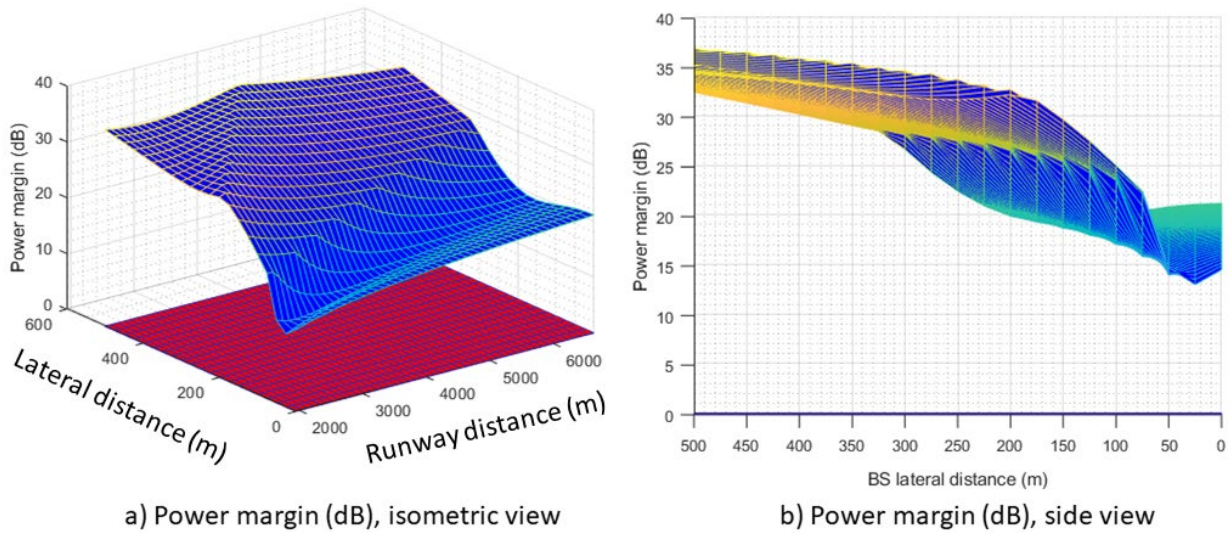

Figure 39: Power margin (dB) as a function of the BS deployment distance (m) along the runway axis D_{BS} and lateral axis L_{BS} for 4x4 AAS (adjacent-band case)

A3.7.2.3 In-band non-AAS case – RA protection in 4100-4200 MHz

Figure 45 shows the power margin for different base station deployment distances on the runway axis (D_{BS}) and lateral axis (L_{BS}). The minimum power margins being equal to 20.5 dB, RA are fully protected from harmful interference.

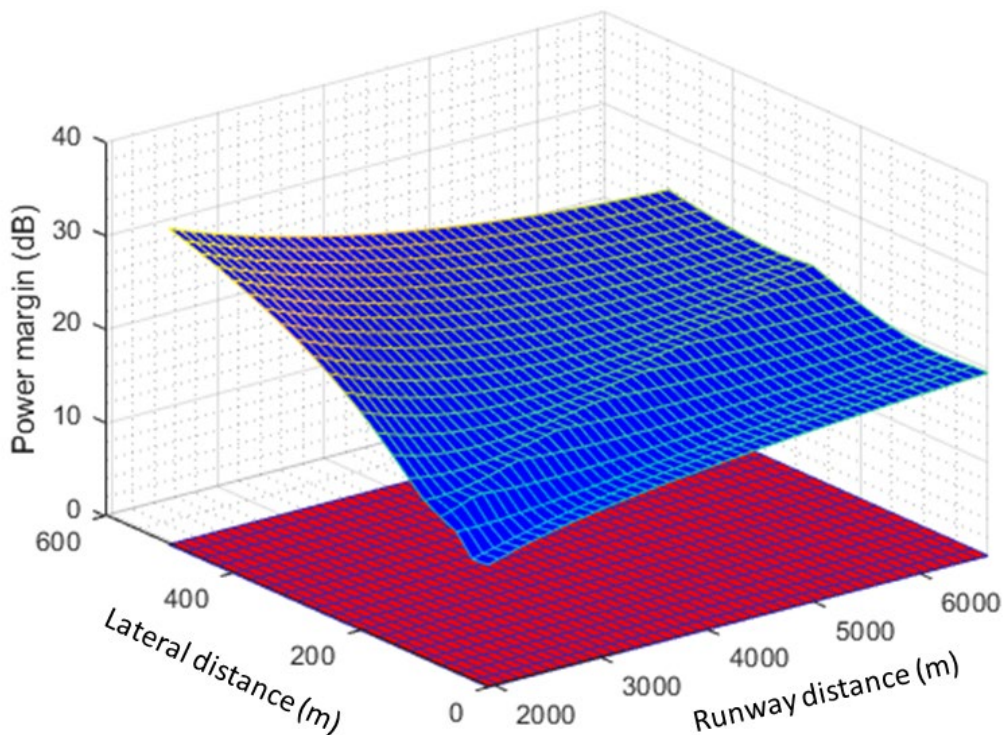

Figure 40: Power margin (dB) as a function of the BS deployment distance (m) along the runway axis D_{BS} and lateral axis L_{BS} for non-AAS (in-band case)

A3.7.2.4 Adjacent-band non-AAS case – RA protection in 4200-4400 MHz

Figure 46 shows the power margin for different base station deployment distances on the runway axis (D_{BS}) and lateral axis (L_{BS}). The minimum power margins being equal to 19.3 dB, RA are fully protected from harmful interference.

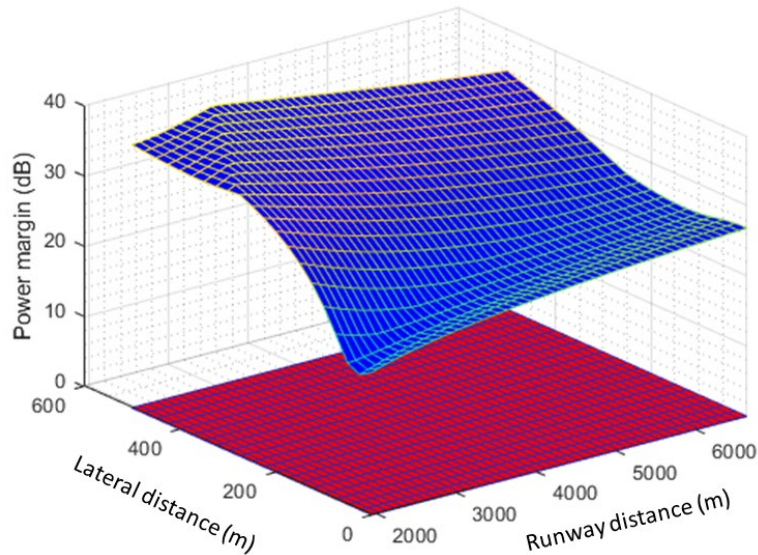

Figure 41: Power margin (dB) as a function of the BS deployment distance (m) along the runway axis D_{BS} and lateral axis L_{BS} for non-AAS (adjacent-band case)

A3.7.3 Conclusions

A3.7.3.1 Coordination zone: Aircraft below 200 feet

The coordination zone aims to protect the Radio Altimeters during the final landing approach where the aircraft is below 200 feet height. In this phase, automatic landing procedure can be activated, and failure to report a correct height may result in a life-threatening situation for aircraft passengers. As such, the ICAO safety margin of 6 dB was used for the studies delimiting the coordination zone. The parameters used for RA protections are from Parameter Set 2 (breakpoints & antenna model) presented in section 4.3.

The results show that WBB LMP base stations (4100-4200 MHz) with 51 dBm *e.i.r.p.*, not equipped with AAS, do not cause harmful interference to Radio Altimeters when the minimum BS height is set to 4 m and the minimum BS distance from TDP is in accordance with the OLS limitations corresponding to that height, as the difference between the highest interference power and the protection criteria is never lower than 6 dB (taking into consideration the ICAO safety margin of 6 dB). It is assumed in the studies that the base station antenna main beam never points above 0° of horizon.

However, for WBB LMP base stations equipped with AAS, it was observed in the study results that interference from out-of-band emission violate the Radio Altimeter protection criteria for a limited zone where the base station could theoretically be deployed but with limitation regarding the antenna height (depending on the ground level) due to aviation provisions. This coordination zone can be defined by a rectangle of width 990 m (from the TDP, runway axis), half-height 20 m plus $L_{deviation}$ (m), to take into consideration the aircraft lateral deviation (to be defined by avionics experts).

Therefore, under the assumptions that

- *e.i.r.p.* is limited to 51 dBm;
- Antenna main beam never point above 0° horizon.

Radio Altimeters are always protected from non-AAS WBB LMP base station (4100-4200 MHz).

For AAS WBB LMP, complying with OLS:

- Adopting a BEM described in Table 30 meets 6 dB ICAO safety margin for Radio Altimeters from all WBB LMP base station heights (4100-4200 MHz) and for both AAS configurations 4x4 and 8x8;
- Alternatively, Radio Altimeters are protected from WBB LMP interference (BEM from Table 22; 4100-4200 MHz) for all BS heights when the BSs are located outside a coordination zone (see Figure 47) defined by a rectangle of width 790 m, half-height $20 + L_{deviation}$ (m).

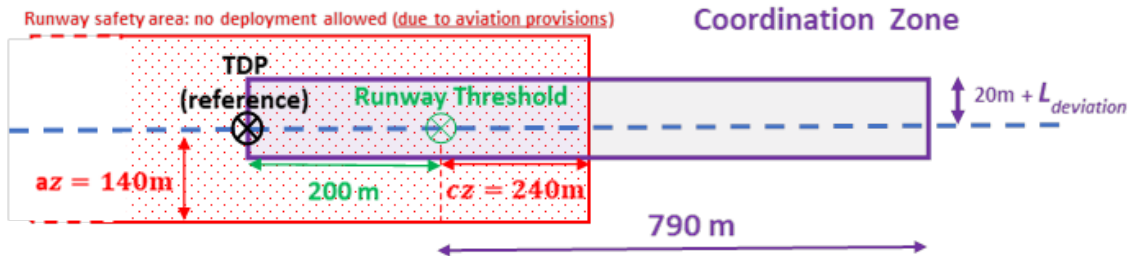

(Figure not scaled)

Figure 42: WBB LMP base station deployment condition near the runway in the 4100-4200 MHz band with ECC Decision (11)06 BEM for TRP of 26 dBm

When adopting a BEM derived from ETSI (TS 138 104 V17.11.0 (2023-10, section 9.7.4 and table 6.6.4.2.3-2 [36]), which is less constraining than that of ECC Decision (11)06 [8], it is shown that negative power margins of -6.2 and -10.9 dB result for AAS 4x4 and 8x8 respectively for a BS height of 6 m (including the 6 dB ICAO safety margin). This will increase the required coordination zone to 1200 m from the runway threshold (see Figure 48).

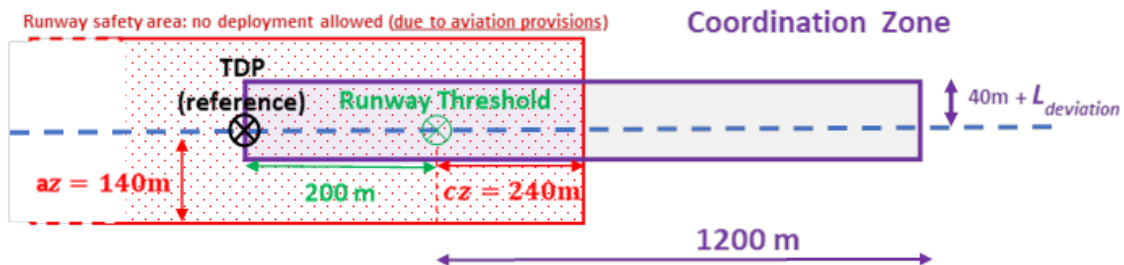

(Figure not scaled)

Figure 43: WBB LMP base station deployment condition near the runway in the 4100-4200 MHz band with BEM derived from ETSI TS 138 104

It can be seen that for AAS 4x4, the BEM derived from ETSI with 6 dB reduction (more constraining) ensures to nearly fulfil the Radio Altimeter threshold with the 6 dB ICAO safety margin with a BS height higher than 6 m (a margin of -0.4 dB at 6 m BS height is observed).

A3.7.3.2 Precautionary zone: Aircraft between 200 feet and 1000 feet

The precautionary zone aims to protect the Radio Altimeters when the aircraft starts its landing phase at 1000 feet, down to 200 feet. This phase is less critical than the case where the aircraft is below 200 feet, so no safety margin has been considered.

The results demonstrate that WBB LMP base station with 51 dBm *e.i.r.p.*, equipped with AAS or not, never cause harmful interference to Radio Altimeters as the difference between the highest interference power and the protection criteria never exceeds 11.4 dB. It is assumed in the studies that the base station antenna main

beam never points above 0° of the horizon. The AAS radiation pattern is modelled based on Recommendation ITU-R M.2101 [31]. While it is unclear if this recommendation captures all characteristics of the AAS currently being deployed, it is very unlikely that the grating lobe power of the AAS being deployed is 11.4 dB higher than the one modelled with Recommendation. ITU-R M.2101.

Therefore, under the assumptions that

- *e.i.r.p.* is limited to 51 dBm;
- Antenna main beam never point above 0° horizon.

There is no need to define a precautionary zone for WBB LMP base station (4100-4200 MHz).

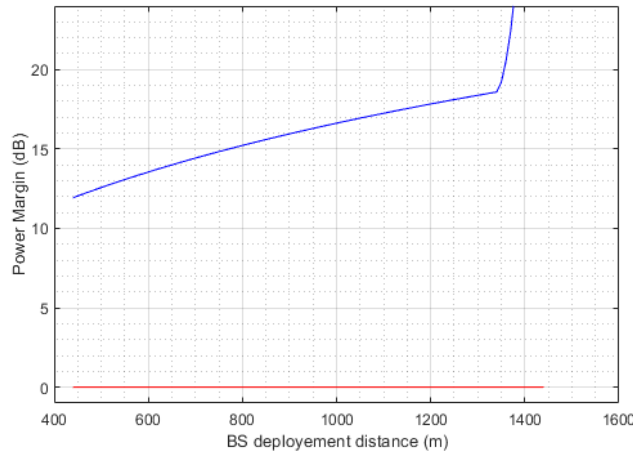

Figure 44: Power margin (dB) as a function of the BS deployment distance (m) within the runway axis, adjacent band non-AAS case

A3.8 RESULTS OF COMPATIBILITY STUDIES FOR WBB LMP BASE STATION (4100-4200 MHz)

A3.8.1 Aircraft between 200 feet and 1000 feet

A3.8.1.1 In-band AAS case – RA protection in 3800-4100 MHz

Figure 27 shows the power margin for different base station deployment distance in the runway axis, for both 8x8 AAS and 4x4 AAS cases. The minimum power margin is 17.5 dB for the 8x8 AAS case and 15.4 dB for the 4x4 AAS case. As the power margins are positives, RA are fully protected from harmful interference.

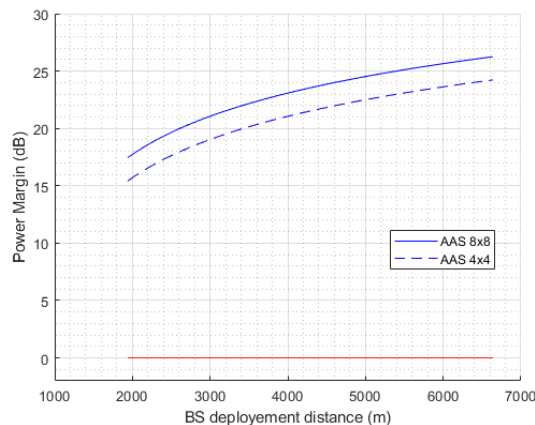

Figure 45: Power margin (dB) as a function of the BS deployment distance (m) within the runway axis, AAS 8x8 and 4x4 cases

Figure 28 shows the base station interfering power (dBm) as a function of the aircraft height when the base station is deployed at distance $D_{BS} = 5000$ m from the TDP in the runway axis, as an example.

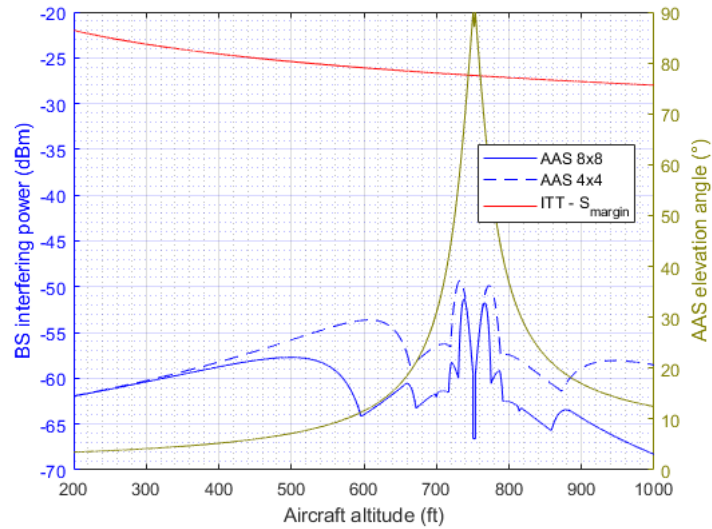

Figure 46: Base station interfering power (dBm) as a function of the aircraft height (feet) for a base station deployed at $D_{BS} = 5000$ m within the runway axis

A3.8.1.2 Adjacent-band AAS case – RA protection in 4200-4400 MHz

The unwanted emission of WBB LMP base stations does not cause harmful emission when the aircraft is below 200 feet. As there are no safety margins for studies for delimiting precautionary zones, and the aircraft is at higher height than 200 feet, then RA are also protected in such case.

A3.8.1.3 In-band non-AAS case – RA protection in 3800-4100 MHz

Figure 29 shows the power margin for different base station deployment distance in the runway axis. The minimum power margin being equals to 20.5 dB, RA are fully protected from harmful interference.

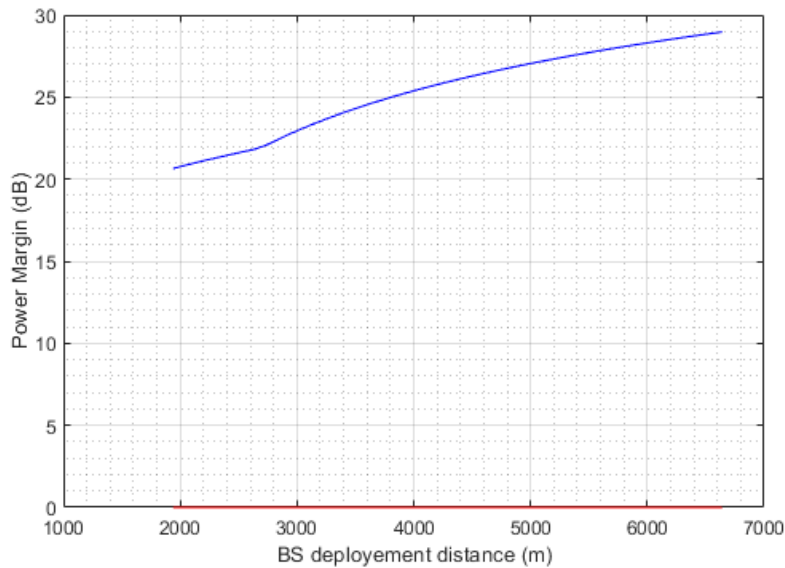

Figure 47: Power margin (dB) as a function of the BS deployment distance (m) within the runway axis, in-band non-AAS case

A3.8.1.4 Adjacent-band non-AAS case – RA protection in 4200-4400 MHz

Figure 30 shows the power margin for different base station deployment distance in the runway axis. The minimum power margin being equals to 25 dB, RA are fully protected from harmful interference.

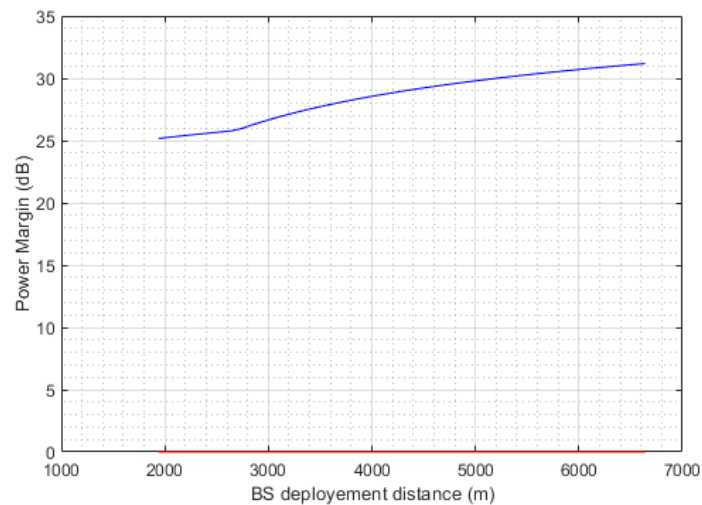

Figure 48: Power margin (dB) as a function of the BS deployment distance (m) within the runway axis, in-band non-AAS case

A3.8.2 Conclusions

A3.8.2.1 Coordination zone: Aircraft below 200 feet

The coordination zone aims to protect the Radio Altimeters during the final landing approach where the aircraft is below 200 feet height. In this phase, automatic landing procedure can be activated, and failure to report a correct height may results in a life-threatening situation for aircraft passengers. As such, the ICAO safety margin of 6 dB was used for the studies delimiting the coordination zone. The parameters used for RA protections are from Parameter Set 2 (breakpoints & antenna model) presented in section 4.3.3. The interference tolerance threshold is assumed constant below 200 feet.

The results show that WBB LMP base station with 51 dBm *e.i.r.p.*, whether equipped with AAS or not, do not cause harmful interference to Radio Altimeters. The difference between the highest interference power and the protection criteria is never lower than 1.4 dB (taking into consideration the ICAO safety margin of 6 dB). It is assumed in the studies that the base station antenna main beam never points above 0° of horizon.

It is important to mention that the studies model the AAS radiation pattern based on Recommendation ITU-R M.2101. It is unclear if this recommendation captures all characteristics of the AAS currently being deployed, or that will be developed in the future. A detailed analysis of the results indicate that the highest interference power corresponds to the case where the AAS grating lobes are – above 45° elevation – and are pointing towards the Radio Altimeter. As the margin is relatively low (a few dB), AAS having grating lobes with higher gain than the one considered in the studies may result in a violation of the protection criteria. As the coordination zone protects the Radio Altimeters up until 200 feet aircraft height (1.33 km distance from the TDP in runway axis), this case happens if the base station is located:

- At a lateral distance (perpendicular to the runway axis) of $200 \times 0.305 \times \cos 45^\circ = 43$ m
- At distance of $1.33 + 0.043 = 1.38$ km from the TDP on the runway axis, that corresponds to $1.38 - 0.2 = 1.18$ km from the runway edge.

Therefore, under the assumptions that

- *e.i.r.p.* is limited to 51 dBm;
- Antenna main beam never point above 0° horizon.

Then Radio Altimeters are protected from WBB LMP base station (3800-4100 MHz) interference, and a coordination zone is not required.

A3.8.2.2 Precautionary zone Aircraft between 200 feet and 1000 feet

The precautionary zone aims to protect the Radio Altimeters when the aircraft starts its landing phase at 1000 feet, down to 200 feet. This phase is less critical than the case where the aircraft is below 200 feet, so no safety margin has been considered.

The results demonstrate that WBB LMP base stations with 51 dBm *e.i.r.p.*, equipped with AAS or not, do not cause harmful interference to Radio Altimeters as the difference between the highest interference power and the protection criteria never exceeds 15 dB. It is assumed in the studies that the base station antenna main beam will never point above 0° of the horizon. The AAS radiation pattern is modelled based on Recommendation ITU-R M.2101. While it is unclear if this recommendation captures all characteristics of the AAS currently being deployed, it is very unlikely that the grating lobe power of the AAS being deployed is 15 dB higher than the one modelled with Recommendation ITU-R M.2101.

Therefore, under the assumptions that

- *e.i.r.p.* is limited to 51 dBm;
- Antenna main beam never point above 0° horizon.

There is no need to define a precautionary zone for WBB LMP base station (3800-4100 MHz) to protect Radio Altimeters.

A3.9 ADDENDUM: ELECTRONICAL TILTS IN AAS

A3.9.1 AAS RADIATION PATTERN CALCULATION

Considering one beam targeting an user equipment (UE), the antenna gain of AAS observed at azimuth angle φ , elevation angle θ , is provided by Recommendation ITU-R M.2101 and is mathematically expressed through the following set of equations

$$G_{AAS}(\theta, \varphi) = A_E(\theta, \varphi) + 20 \log_{10} \left| \sum_{m=1}^{N_H} \sum_{n=1}^{N_V} w_{n,m} v_{n,m} \right|$$

Equation 25

$$A_E(\theta, \varphi) = G_{E,max} + \min \left[-\min \left(12 \left(\frac{\varphi}{\varphi_{3db}} \right)^2, A_m \right) - \min \left(12 \left(\frac{\theta}{\theta_{3db}} \right)^2, SLA_V \right), A_m \right]$$

Equation 26

$$w_{n,m} = \frac{1}{\sqrt{N_H N_V}} \exp \left(j2\pi \left((m-1) \frac{d_v}{\lambda} \sin \theta_{etilt} - (n-1) \frac{d_h}{\lambda} \cos \theta_{etilt} \sin \varphi_{escan} \right) \right)$$

Equation 27

$$v_{n,m} = \exp \left(j2\pi \left((m-1) \frac{d_v}{\lambda} \sin \theta - (n-1) \frac{d_h}{\lambda} \cos \theta \sin \varphi \right) \right)$$

Equation 28

These equations are adapted to the coordinate system shown in Figure 49, where $\theta > 0$ corresponds to an elevation angle above the horizon.

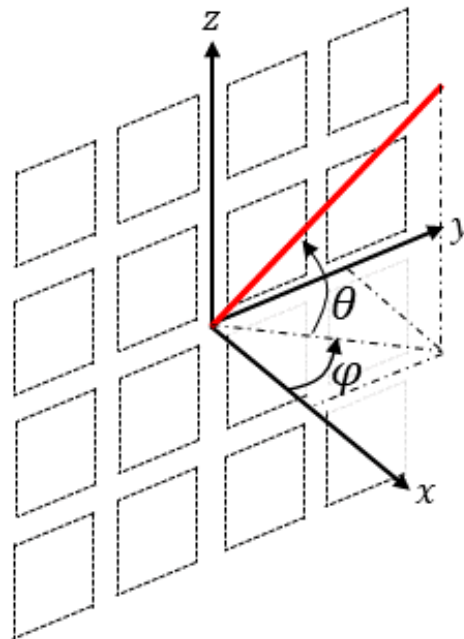

Figure 49: AAS reference coordinate system used in this study

Table 35 presents the different parameters used as reference in this study. Note that the AAS model presented here does not include the sub-array case, for simplicity. The couple of variables $(\theta_{etilt}, \varphi_{escan})$ in Equation 28 corresponds to the electrical angles (elevation, azimuth) that are used to focus the beam in the direction defined by the angles $(\theta_{etilt}, \theta_{escan})$. Therefore, the choice of these electrical tilts affects the results of the equation. To better reflect this fact, the notations in Equation 25 are slightly modified to indicate that the AAS radiation pattern G_{AAS} is now a function of 4 variables: the angles (θ, φ) where the antenna gain is observed/measured and the electrical angles $(\theta_{etilt}, \varphi_{escan})$ where the beam is directed.

$$G_{AAS}(\theta, \varphi, \theta_{etilt}, \varphi_{escan}) = A_E(\theta, \varphi) + 20 \log_{10} \left| \sum_{m=1}^{N_H} \sum_{n=1}^{N_V} w_{n,m}(\theta_{etilt}, \varphi_{escan}) v_{n,m}(\theta, \varphi) \right|$$

Equation 29

Table 35: Beamforming AAS characteristics for IMT in 1710-4990 MHz

Parameter	Notation	Value
Element gain (dBi)	$G_{E,max}$	6.4
Horizontal/vertical 3 dB beam width of single element (degree)	$\varphi_{3db}/\theta_{3db}$	90° for H, 65° for V
Horizontal/vertical front-to-back ratio (dB)	A_m, SLA_V	30 dB for both H/V
Antenna array configuration (Row × Column),	$N_V \times N_H$	8 × 8 elements
Horizontal/Vertical radiating element/sub-array spacing	d_h, d_v	0.5 of wavelength for H, 0.7 of wavelength for V

A3.9.2 FUNCTION OF THE ELECTRONICAL TILTS

One of the major advantages of using AAS is to provide a way to electronically control the beam in order to focus the power in a given direction – where user equipment is located. This beam is controlled through the electronic tilts (θ). Therefore, it is important to understand that, contrary to mechanical tilts, the electronic tilts of the AAS can be dynamically configured even when the base station is deployed. If UEs are moving, it is possible (to some extent) to dynamically track them by adjusting electronic angles so that the beam “follows” the UEs. This means the electronic tilts can theoretically take all possible values within the base station coverage angles.

By nature, the UE positions are not fixed and vary over time. This implies that, each time an aircraft is landing, the UE positions may be different and random, uncorrelated to the aircraft positions¹⁴. Over a large observation time, the beam swept most of the directions within the base station coverage angles. It is fair to assume that the beam orientation cannot exceed the coverage limitations of the base station. For instance, taking WBB LMP base stations, the coverage in azimuth is $\pm 60^\circ$ ($\Rightarrow \varphi_{escan} \in [-60^\circ, 60^\circ]$) and 0° to 30° below the horizon in elevation ($\Rightarrow \theta_{etilt} \in [-30^\circ, 0^\circ]$). This assumes mechanical tilts of 0° .

Therefore, to take into consideration all possible beam directions, it is straightforward to consider an AAS radiation pattern envelope calculated by taking the maximum AAS gain from all possible electronic tilt angles within the coverage limitations of the base station. This translates to the following mathematical formula:

$$G_{AAS,max}(\theta, \varphi) = \max_{\theta_{etilt}, \varphi_{escan}} (G_{AAS}(\theta, \varphi, \theta_{etilt}, \varphi_{escan}))$$

Equation 30

For the Radio Altimeter computability studies, (θ, φ) corresponds to the azimuth/elevation angles between the BS and Radio Altimeter during the aircraft landing phase. These angles are independent from the UE positions. Therefore, considering such radiation pattern envelope for calculating the base station interference power in the methodology is mathematically equivalent of directly finding the worst-case (highest) base station interference power from all realistic AAS beam orientation (within the base station coverage angles).

A3.9.3 ILLUSTRATIVE EXAMPLE: ELECTRONICAL TILTS VERSUS MECHANICAL TILTS

Figure 50 provides an example that illustrates the importance of considering the electronic tilts. This figure shows 3 different AAS radiation patterns in the vertical (elevation) plane:

- 1 Green curve: “Typical” antenna radiation pattern obtained using Equation 29 with $\varphi_{escan} = \theta_{etilt} = 0^\circ$. No mechanical tilts are applied ($\theta_{mtilt} = 0^\circ$)
- 2 Red curve: taking the envelope over mechanical elevation tilts from 0° to 30° below the horizon ($\theta_{mtilt} \in [-30^\circ, 0]$), without any electronic tilts ($\theta_{etilt} = \varphi_{escan} = 0^\circ$).
- 3 Blue curve: taking the envelope over electronic elevation tilts from 0° to 30° below the horizon ($\theta_{etilt} \in [-30^\circ, 0]$, $\varphi_{escan} = 0^\circ$), without any mechanical tilts ($\theta_{mtilt} = 0^\circ$).

AAS parameters are based on Table 35 for all three curves.

¹⁴ This is only true if UEs embedded in the aircrafts are not communicating with the BS on the ground level. This case is not taken into consideration in the studies as the coverage angles are defined below the horizon (0°), so the beam cannot point toward the aircraft.

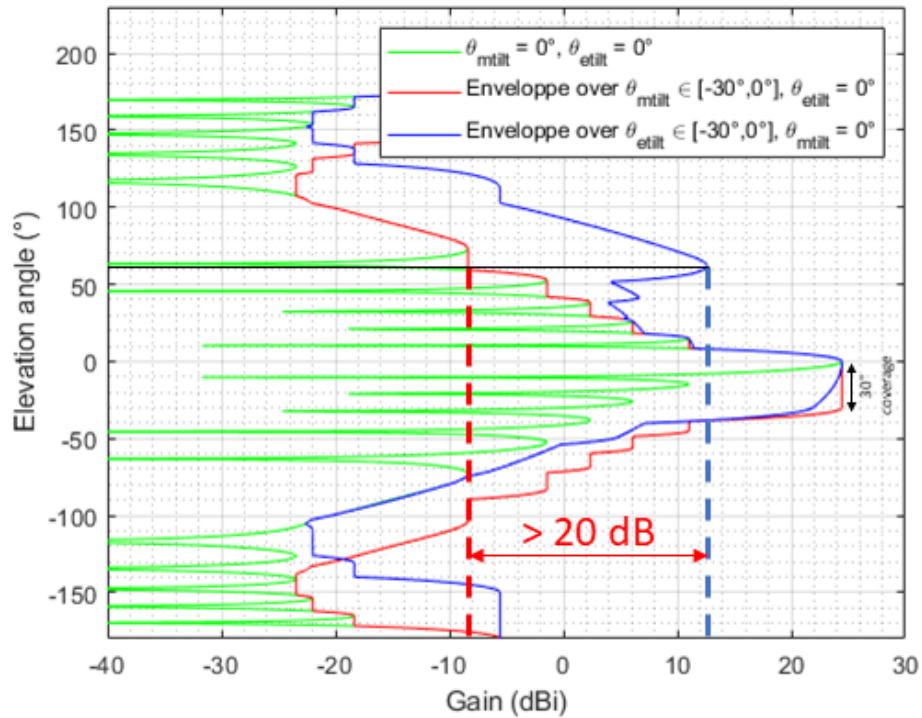
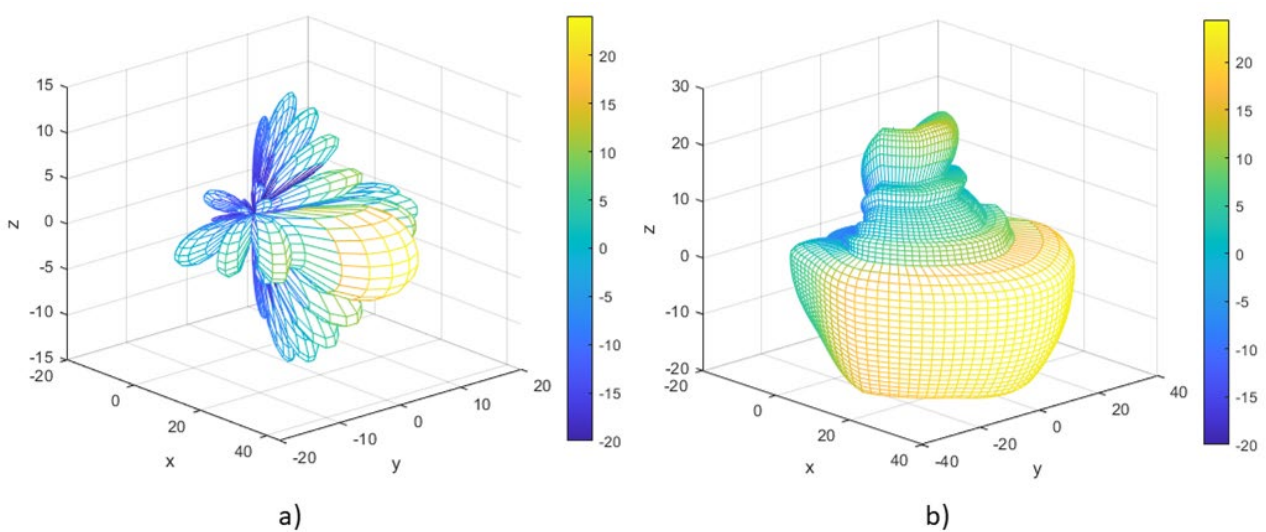

Figure 50: Difference of AAS radiation pattern envelope when considering either mechanical tilts or electronic tilts

As it can be seen in the figure, the obtained radiation patterns are completely different. At elevation angle around 60°, it can be observed that the grating lobe gain of the blue curve (electronic tilts envelope) is much higher than the one obtained by the red curve (mechanical tilts envelope), with 20 dB difference. Note that the same 20 dB difference is observed between the blue and the green curve (where electronic angles are fixed to 0°). Such difference can radically change the conclusion of the computability studies.

Finally, Figure 51 shows the AAS radiation pattern (Table 35 parameters) when a) not taking any envelope b) taking any envelope over the electronic tilt angles for a base station coverage of ±60° in azimuth and 0° to 30° below horizon in elevation.



**Figure 51: AAS radiation pattern a) No envelope ($\varphi_{escan} = \theta_{etilt} = 0^\circ$)
b) with envelope ($\theta_{etilt} \in [-30^\circ, 0]$, $\varphi_{escan} \in [-60^\circ, 60^\circ]$)**

ANNEX 4: (STUDY C) SIMULATION RESULTS FOR RADIO ALTIMETER 4200-4400 MHZ COEXISTENCE WITH MFCN OPERATED IN 3300-3800 MHZ USING MULTIPLE PARAMETER SETS

A4.1 METHODOLOGY

This section details the methodology considered in this study using both Set 1 and Set 2 RA parameters. This approach consists of a three-dimensional grid-based analysis over which MFCN emissions and RA interference tolerance thresholds are compared to a discrete points on the grid. The following assumptions are made:

- 1 A three-dimensional rectangular coordinate system grid is established with the origin as the centre point of a runway consistent with the scenario described in section 5.
 - i) The grid is bounded by a deviation distance from the edge of the runway in the x direction (parallel to runway).
 - ii) The grid is bounded by a deviation distance from the runway centreline in the y direction (perpendicular to runway).
 - iii) The grid is bounded by 1000 feet / 304.8 meters in the z direction.
- 2 Two surfaces are defined within the bounds of the grid described in part 1.
 - i) An aircraft minimum surface ("AMS") is defined. For this surface it is assumed the aircraft can be positioned at any point at or above a surface defined by the shallowest aircraft glideslope approach to the closest touch-down-point to the runway threshold:
 - The aircraft analysis points are defined using independent x, y, and z step sizes;
 - The aircraft x and y coordinates fall on multiples of the respective x and y step sizes;
 - The aircraft z coordinate at any arbitrary x,y coordinate is defined based on the agreed scenario and glide slope described in section 5.1.
 - At each aircraft x and y coordinate, the aircraft z coordinate is increased by the z step-size until the upper z-bound is reached.
 - ii) The OLS is defined. For this surface it is assumed that the MFCN base station antenna is located at the lowest of any point on the surface or 35 metres.
 - The base station analysis points are defined using independent x, y, and z step sizes.
 - The base station x and y coordinates fall on multiples of the respective x and y step sizes.
 - The base station z coordinate at any arbitrary x,y coordinate is defined based on the agreed scenario in section 5.2 bounded by 35 meters.
- 3 A single base station is located at each possible base station (x,y,z) coordinate set and is assessed against an aircraft located at all possible (x,y,z) aircraft coordinates.¹⁵
 - i) Given the coordinate-based system, a slant range and angle allow for path loss and antenna gain values to be calculated.
 - ii) The maximum calculated ITT power exceedance¹⁶ from the single base station based on the assessment of all possible positions of the aircraft is reported at each base station (x,y,z) location.
- 4 The results are plotted to show a "compatibility" map based on all the assumptions made in the analysis.

¹⁵ An assessment is not performed for base stations with a height less than 10 metres.

¹⁶ A positive ITT power exceedance is reflective of a negative margin; a negative ITT power exceedance is reflective of a positive margin.

A4.2 INPUTS AND ASSUMPTIONS

A4.2.1 MFCN Base Station assumptions

A4.2.1.1 MFCN Base Station AAS Antenna

This section describes the three different MFCN base station antenna patterns and related assumptions used in this study.

- 1 The first MFCN base station antenna pattern, labelled 'Baseline MFCN Antenna Pattern', uses the extended AAS model as described in Annex 1, and the beamforming antenna characteristics in the 'Rural Macro' column of Table 12 with a 58 dBm/MHz *e.i.r.p.* limit. It is assumed the radiation pattern is swept over a vertical coverage range of 0° to -10° about the local horizon with a 3° mechanical down-tilt. The maximum gain at each tilt angle is calculated and rotated about the z-axis. Figure 52 shows this assumption in a spherical coordinate system and Figure 53 shows the gain profile as a function of elevation angle where 0° is local zenith and 90° is local horizon.

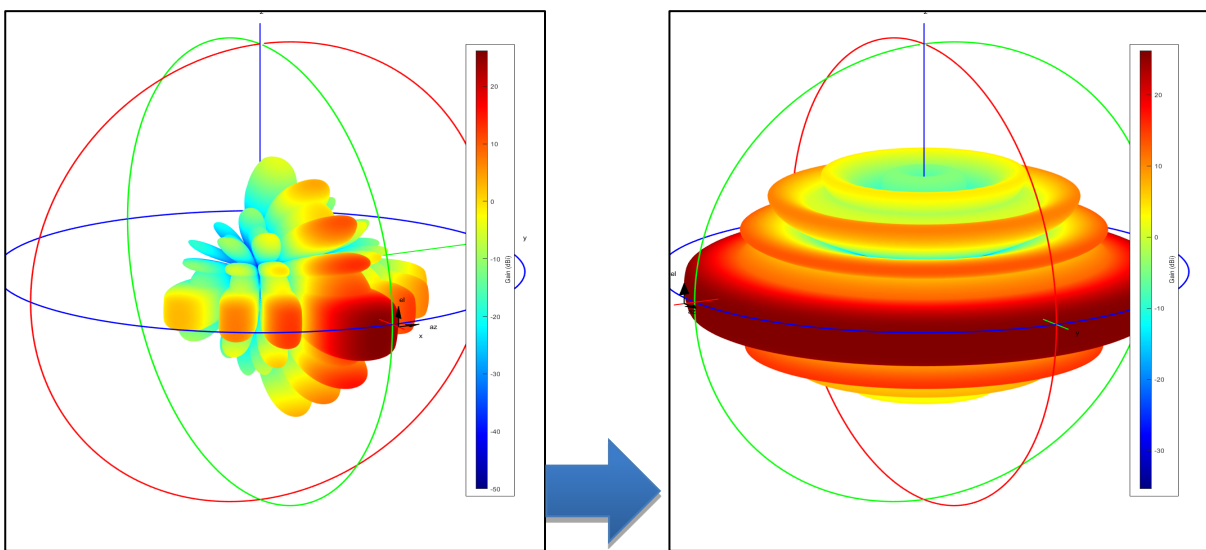

Figure 52: Baseline MFCN Antenna Pattern: Spherical Coordinate System

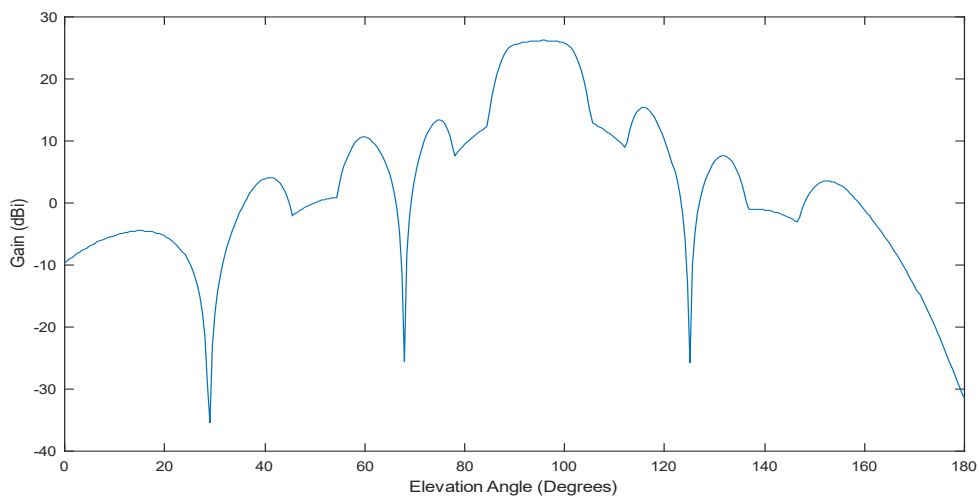

Figure 53: Baseline MFCN Antenna Pattern: Profile

- 2 The second MFCN base station antenna pattern, labelled 'Baseline MFCN Antenna Pattern with Vertical Coverage Range Deviation', uses the extended AAS model as described in Annex 1 and the beamforming antenna characteristics in the 'Rural Macro' column of Table 12 with a 58 dBm/MHz *e.i.r.p.* limit. It is assumed the radiation pattern is swept over a vertical coverage range of 0° to -26° about the local horizon with a 3° mechanical down-tilt. The maximum gain at each tilt angle is calculated and rotated about the z-axis. Figure 54 shows this assumption in a spherical coordinate system and Figure 55 shows the gain profile as a function of elevation angle where 0° is local zenith and 90° is local horizon.

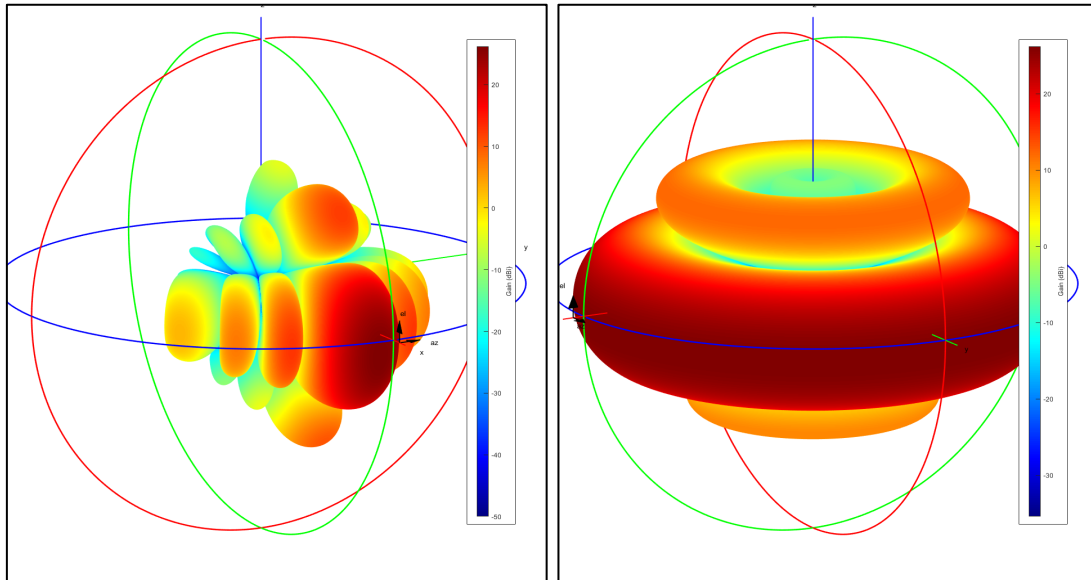

Figure 54: Baseline MFCN Antenna Pattern with Vertical Coverage Range Deviation: Spherical Coordinate System

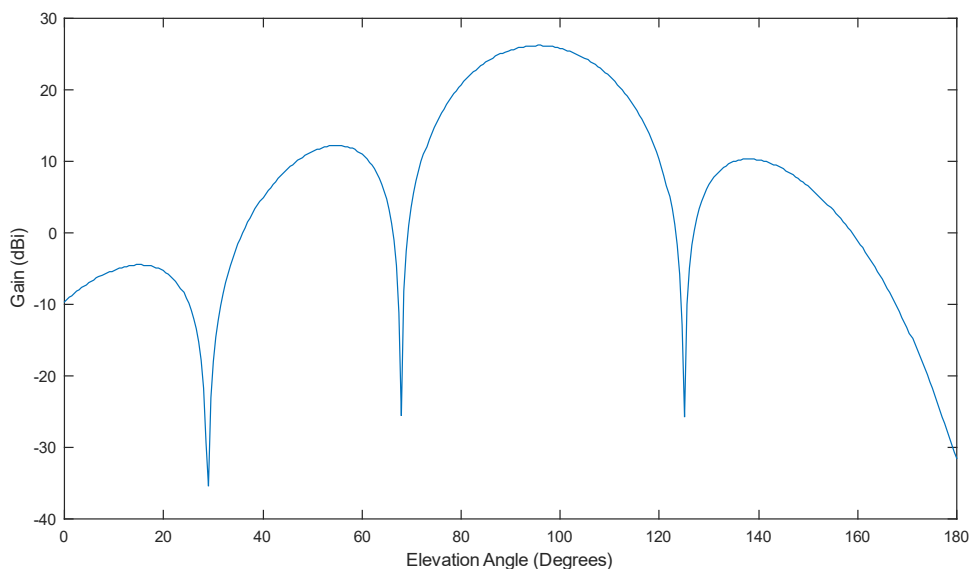

Figure 55: Baseline MFCN Antenna Pattern with Vertical Coverage Range Deviation: Profile

- 3 The third MFCN base station antenna pattern, labelled 'Isotropic Equivalent MFCN Antenna Pattern,' reflects the fact that spectrum regulators may not place any regulatory requirement on base station pointing. Without a regulatory requirement, it may be assumed the base station antenna can point at any combination of azimuth and elevation gain angles. This assumption is reflected by an isotropic equivalent antenna pattern with the maximum gain determined by the AAS antenna maximum gain. Figure 56 shows

this assumption in a spherical coordinate system and Figure 57 shows the gain profile as a function of elevation angle where 0° is local zenith and 90° is local horizon.

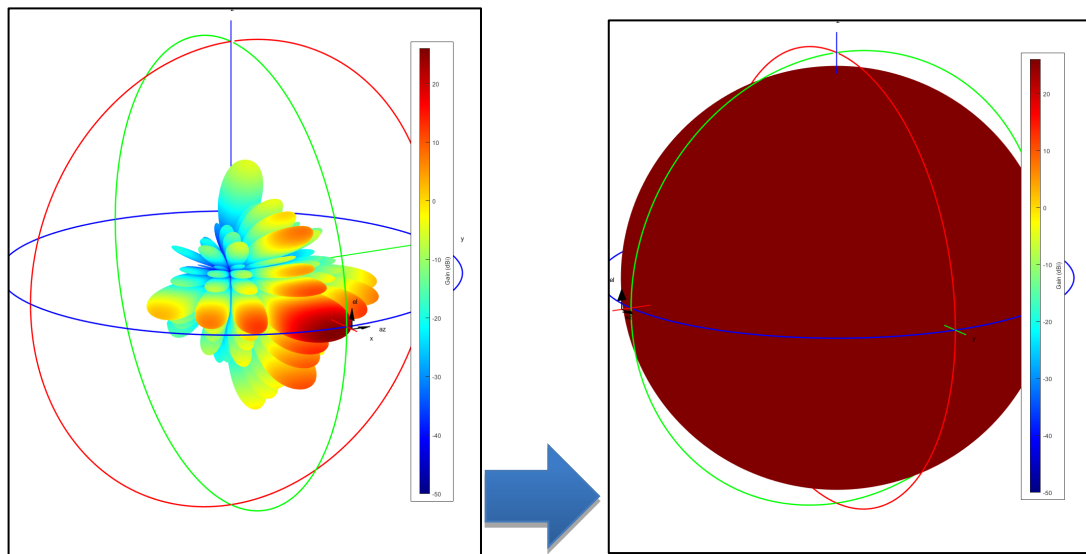

Figure 56: Isotropic Equivalent MFCN Antenna Pattern: Spherical Coordinate System

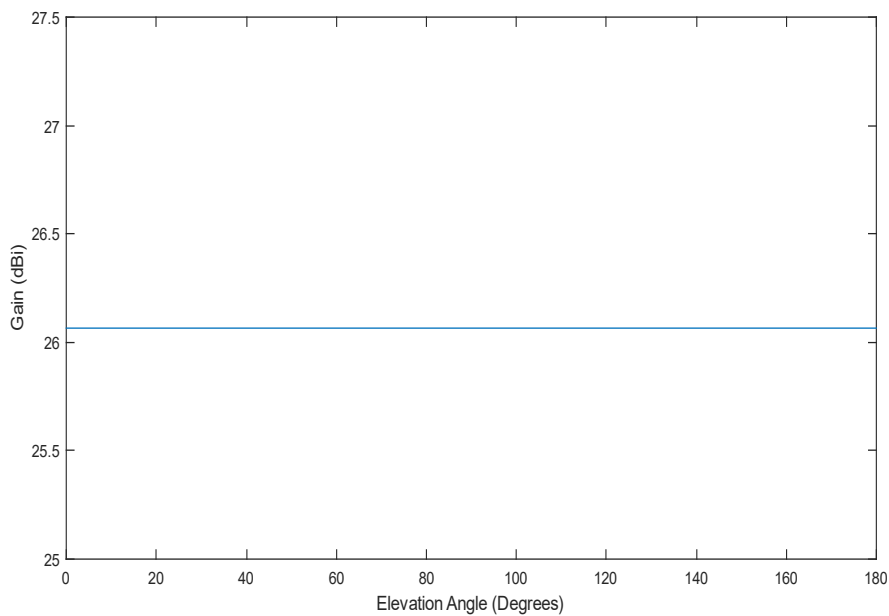

Figure 57: Isotropic Equivalent MFCN Antenna Pattern: Profile

A4.2.1.2 MFCN assumptions in the 3.3-3.8 GHz

An *e.i.r.p.* of 58 dBm/MHz and a polarisation loss of 1.5 dB is considered for all three MFCN base station antenna patterns assumed in this study.

A4.2.1.3 MFCN assumptions in the 4.2-4.4 GHz

This study assumes an isotropic equivalent radiation pattern of -30 dBm/MHz *e.i.r.p.* for the 5G MFCN antenna for the frequency range of 4.2-4.4 GHz. For information purposes this study also assumes an isotropic

equivalent radiation pattern of -13 dBm/MHz *e.i.r.p.* for the 5G MFCN antenna for the frequency range of 4.2-4.4 GHz.

A4.2.2 Radio Altimeter assumptions

A4.2.2.1 Radio Altimeter ITT assumptions in the 3.4-3.8 and 4.2-4.4 GHz Band

This study uses both the out-of-band (OOB) and in-band (IB) ITT in the frequency band 3.4-3.8 GHz and 4.2-4.4 GHz respectively for each RA model considered.

This study also considers the RA performance at all heights in the three-dimension grid and makes assumptions regarding the heights where the ITT is not specified in the ITT parameters sets. This study assumes a stair-step method for extrapolation and both a log-linear and stair-step method for interpolation. Figure 58 and Figure 59 depict the height dependency assumptions.

The stair-step approach provides a conservative approach for considering realistic flight conditions for which data is not available, by assuming RA tolerance no worse than that at the data point at the next highest height. Figure 58 illustrates the case for data points specified at 200 feet and 1000 feet. The breakpoint value specified at 200 feet applies for all heights less than or equal to 200 feet, while the value specified at 1000 feet applies for heights greater than 200 feet. No extrapolation above 1000 feet is considered.

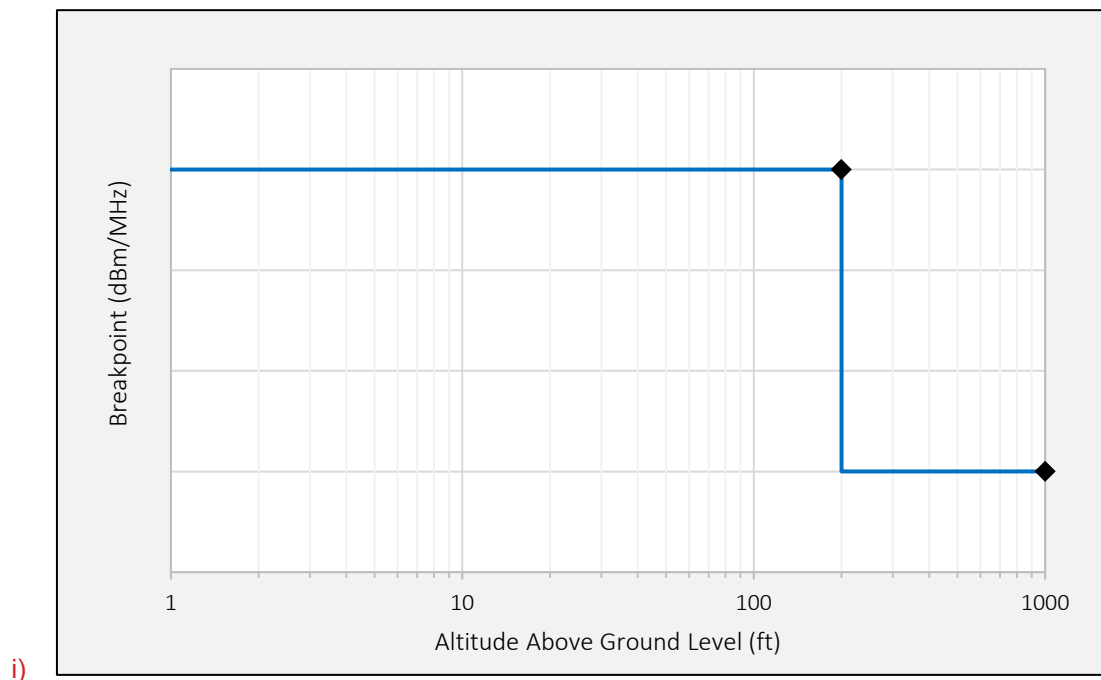

Figure 58: Example of stair-step interpolation and extrapolation

Figure 59 shows an example of log-linear interpolation and stair-step extrapolation. This approach provides a less conservative estimate for tolerances at non-specified heights based on the assumption that the combination of interference source path loss, RA receiver signal-to-noise, and RA receiver sensitivity can be modelled as a log-linear change in tolerance versus height between specified data points for all RA models. The breakpoint value specified at 200 feet applies for all heights less than or equal to 200 feet. No extrapolation above 1000 feet is considered.

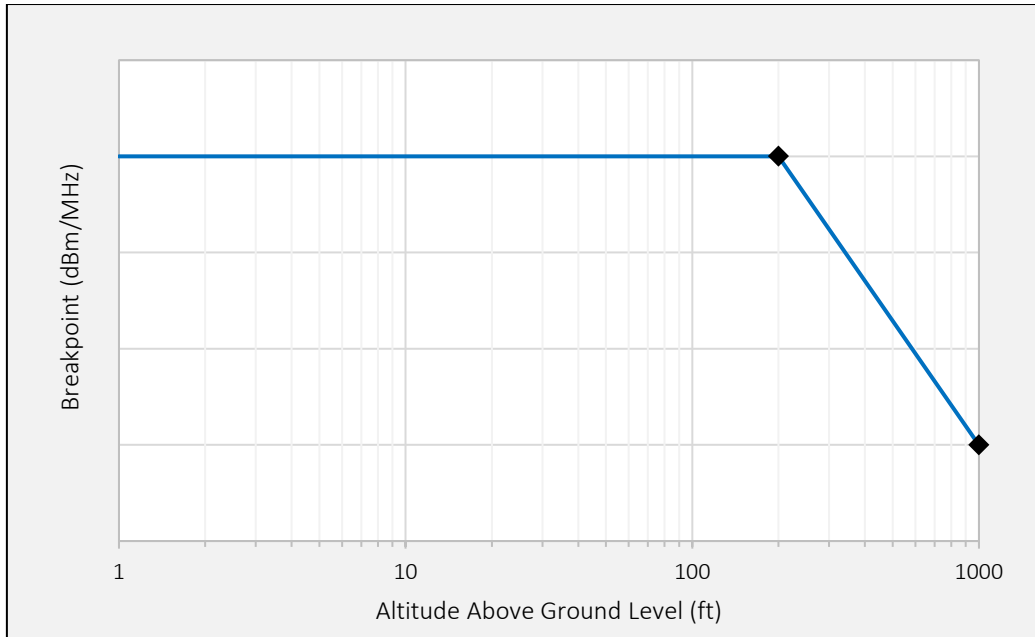

Figure 59: Example of log-linear interpolation and stair-step extrapolation

A4.2.2.2 Radio Altimeter Antenna Assumptions in the 3.4-3.8 and 4.2-4.4 GHz Band

This study uses the Radio Altimeter antenna patterns and cable losses discussed in section 0 in the frequency bands 3.4-3.8 and 4.2-4.4 GHz. The methodology described herein applies both Radio Altimeter antenna set parameters as described in section 4.3.4. Figure 60 depicts the Radio Altimeter antenna pattern with cable losses included for both Set 1 (Red) and set 2 (Blue) for the frequency range of 3.4-3.8 GHz. Figure 61 depicts the Radio Altimeter antenna pattern with cable losses included for both Set 1 (Red) and set 2 (Blue) for the frequency range of 4.2-4.4 GHz.

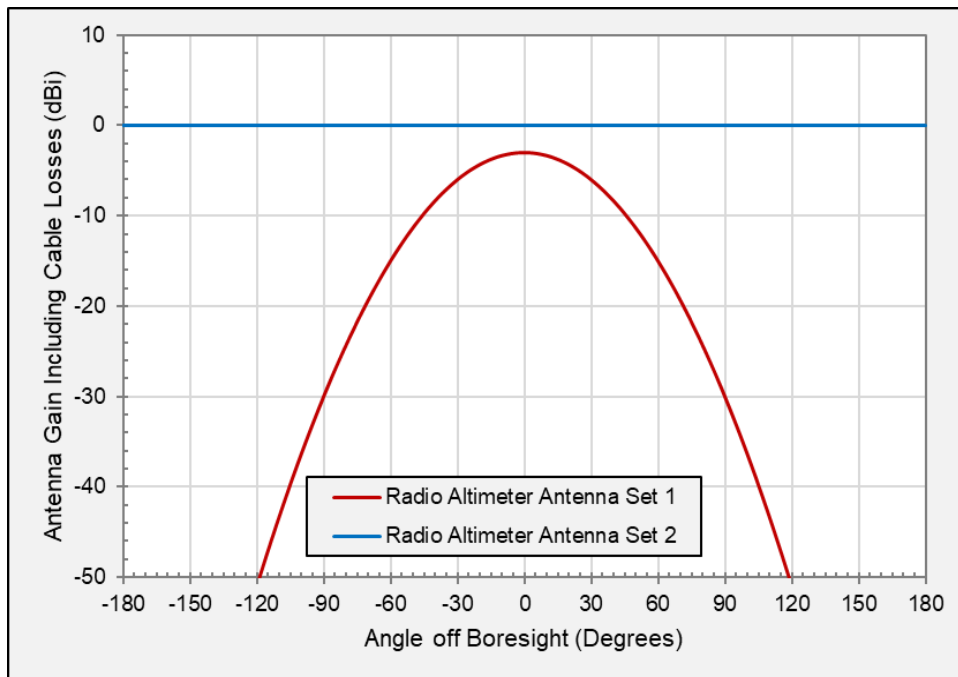

Figure 60: Radio Altimeter Set 1 and 2 Antenna Pattern Including Cable Losses in the 3.4-3.8 GHz Frequency Range

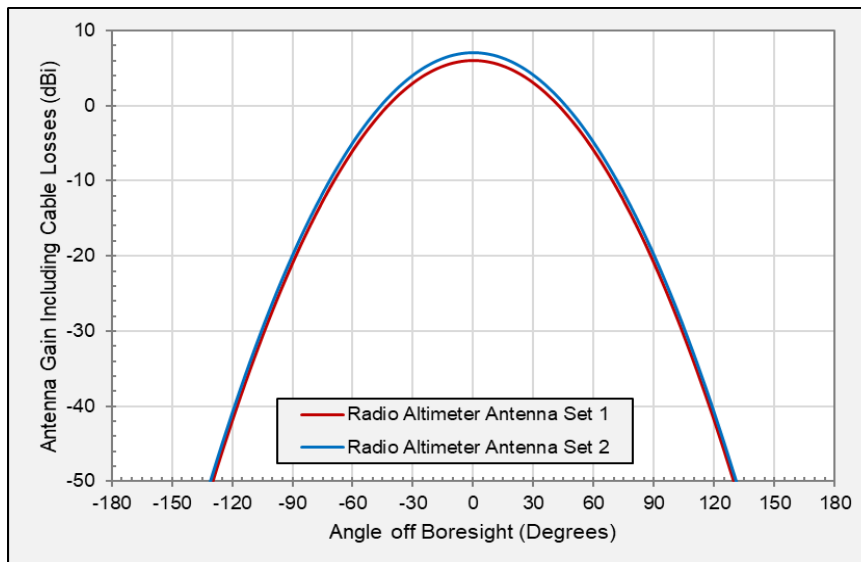

Figure 61: Radio Altimeter Set 1 and 2 Antenna Pattern Including Cable Losses in the 4.2-4.4 GHz Frequency Range

A4.2.2.3 Radio Altimeter Assumptions for the 3.4-3.8 GHz band

The RA parameters discussed in section 4.3 are considered in this study and the methodology described in section A4.1 is applied to those parameters. All simulations were also performed under the assumption the Radio Altimeter ITT below the lowest reported height was essentially unknown; impacts of this deviation are explained in the summary tables in Section A4.5. This study also always applies the ICAO safety margin of 6 dB.

A4.2.3 Scenario Parameters

The runway safety area and obstacle limitation surface detailed in section 5 are considered in this study and the methodology described in section A4.1 of this Annex is applied to those parameters. Table 36 lists the parameters and associated values specifically used as inputs when completing this study.

Table 36: Scenario Parameters Used in this study

Parameter	Value	Units
Runway Length (Note 1)	400	m
Runway Width (Note 1)	140	m
Distance Between Touchdown Point and Threshold (Note 2)	0	m
Distance Between Threshold and Start of OLS in Length (x) Direction (Note 3)	60	m
Distance Between Runway Centreline and Start of OLS in Width (y) Direction (Note 4)	140	m
Analysis Distance Beyond Runway Length	Variable (10000 max)	m
Analysis Distance Beyond Runway Centreline	Variable (2000 max)	m
Base Station Step Size in Length (x) Direction	Variable (5 to 25)	m
Base Station Step Size in Width (y) Direction	Variable (5 to 10)	m

Parameter	Value	Units
Aircraft Position Step Size in Length (x) Direction	Variable (5 to 25)	m
Aircraft Position Step Size in Width (y) Direction	Variable (5 to 10)	m
Aircraft Position Step Size in Height (z) Direction	Variable (5 to 10)	m
OLS Angle in the Length Direction (Note 5)	1.146	degrees
OLS Angle in the Width Direction	8.138	degrees
Aircraft Approach Angle	2.625	degrees
Aircraft Horizontal Deviation (Note 6)	10	m
Aircraft Pitch and Roll Range	0	degrees

Note 1: The runway length and width do not impact the result of this study. See Section A3.3 of this annex for further clarification.
 Note 2: Section 6.2 refers to this distance as 'bx'.
 Note 3: Section 6.2 refers to this distance as 'Strip' or 'cx'.
 Note 4: Section 6.2 refers to this distance as 'az'.
 Note 5: See section 6.2 for further clarification.
 Note 6: This study assumes the aircraft upon approach can deviate horizontally from the approach path by an amount no larger than the "Aircraft Horizontal Deviation" parameter.

This methodology employs the OLS, as described in section 5.2, to define the location of the MFCN base station antennas. The OLS establishes the z coordinates of the base station based on the assumption that MFCN towers will be no higher than the lesser of the local OLS height or 35 metres. Additionally, an assessment is not performed for base stations with a height less than 10 metres

Since aircraft must maintain safety in off-normal operations, an AMS is also defined that is based on the aircraft's possible horizontal deviation on the approach path and by the shallowest aircraft glideslope. This methodology assumes the aircraft can be at or above this AMS because the aircraft can deviate horizontally from the approach path, perform a go-around at any point, or approach the runway at various angles to unique touch-down-points.

Figure 62 and Figure 63 show the OLS and AMS surfaces overlayed on the same plot at different view angles. These plots provide a visual representation of where a base station is assumed to be located and the minimum surface at which an aircraft is assumed to be located. The left heatmap scale is for the OLS; the right-most heatmap scale is for the AMS. The white area in the centre of each plot represents the area where base stations are assumed to not be present.

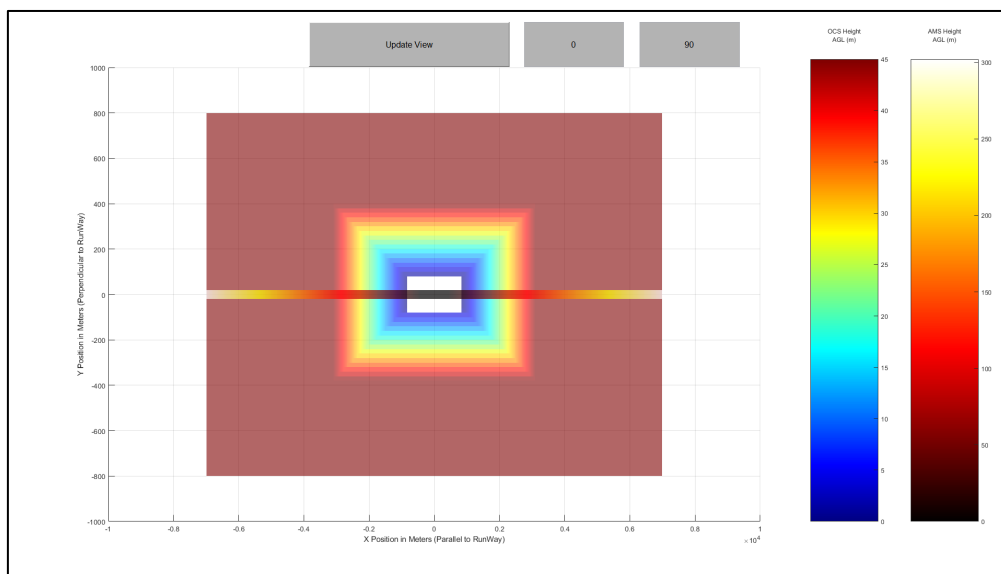

Figure 62: Example top-down view of the study scenario

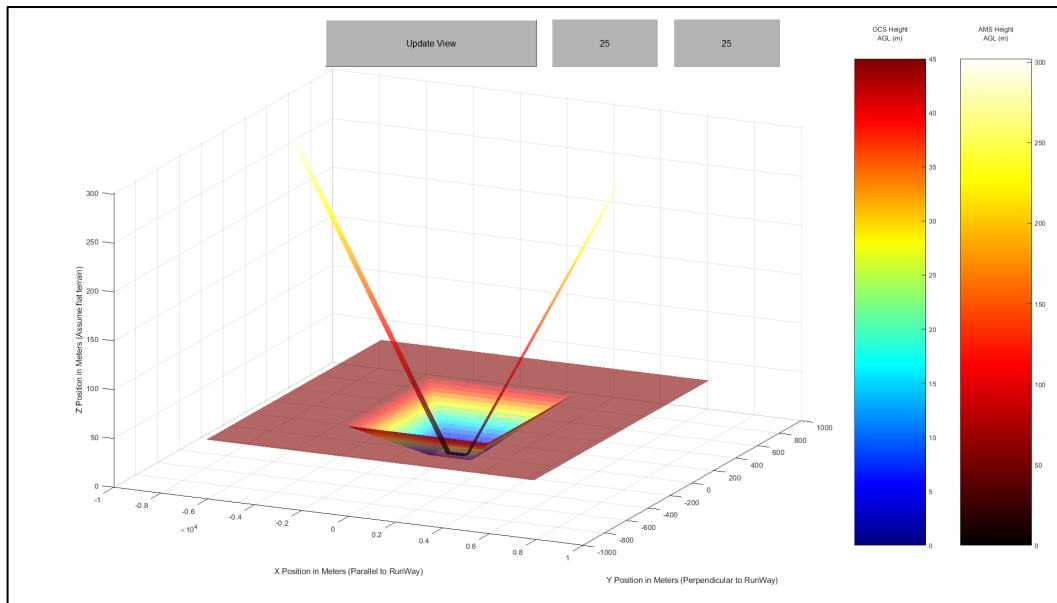

Figure 63: Example oblique view of the study scenario

A4.3 OUTPUTS

A4.3.1 Compatibility Maps

This study outputs a compatibility map necessary to determine where and if there is interference. The compatibility map provides a visual representation of the ITT exceedance by a single base station located at any point and is analysed in order to summarise the results of this study. An example compatibility map is provided below to illustrate the methodology, but over 200 maps considering combinations of the assumptions described above were analysed. The results of this analysis are incorporated in the results summary tables in Table 37 through Table 44. Most compatibility maps have been omitted for brevity.

In the compatibility maps, the origin is the centre of the runway, the x-axis represents the displacement from the runway centre-point in metres parallel to the runway length, the y-axis represents the displacement from the runway centre-point in metres perpendicular to the runway length, the white area in the centre represents the area where base stations are assumed to not be present, and the heat map labelled 'ITT Exceedance' indicates the power level by which the ITT is exceeded if a base station were to be located at that particular x y ordered pair (with the MFCN antenna at the lesser of the OLS height or 35 meters at that point).

Figure 64 is an example of a possible output, with several random data marks. The data mark at (-3662.5, -1300, -4.75) indicates that if a base station were to be located 3662.5 metres offset from the centre-point of the runway in the negative x direction and 1300 metres offset from the centre-point in the negative y direction, that the maximum ITT exceedance by the base station will be -4.75 dB based on all the assumptions made in the analysis and considering all the aircraft's possible positions. In this case, a negative exceedance means that the MFCN signal is less than the interference tolerance threshold level at the input to the RA transceiver. More succinctly, a base station at this location will not exceed the ITT if operated in accordance with all the assumptions made in the analysis. In contrast, the data mark at (-1500, 340, 6.92) indicates that if a base station were to be located 1500 metres offset from the centre-point of the runway in the negative x direction and 340 metres offset from the centre-point in the positive y direction, that the maximum ITT exceedance by the base station will be 6.92 dB based on all the assumptions made in the analysis and considering all the aircraft's possible positions. In short, a base station at this location will exceed the ITT if operated in accordance with all the assumptions made in the analysis.

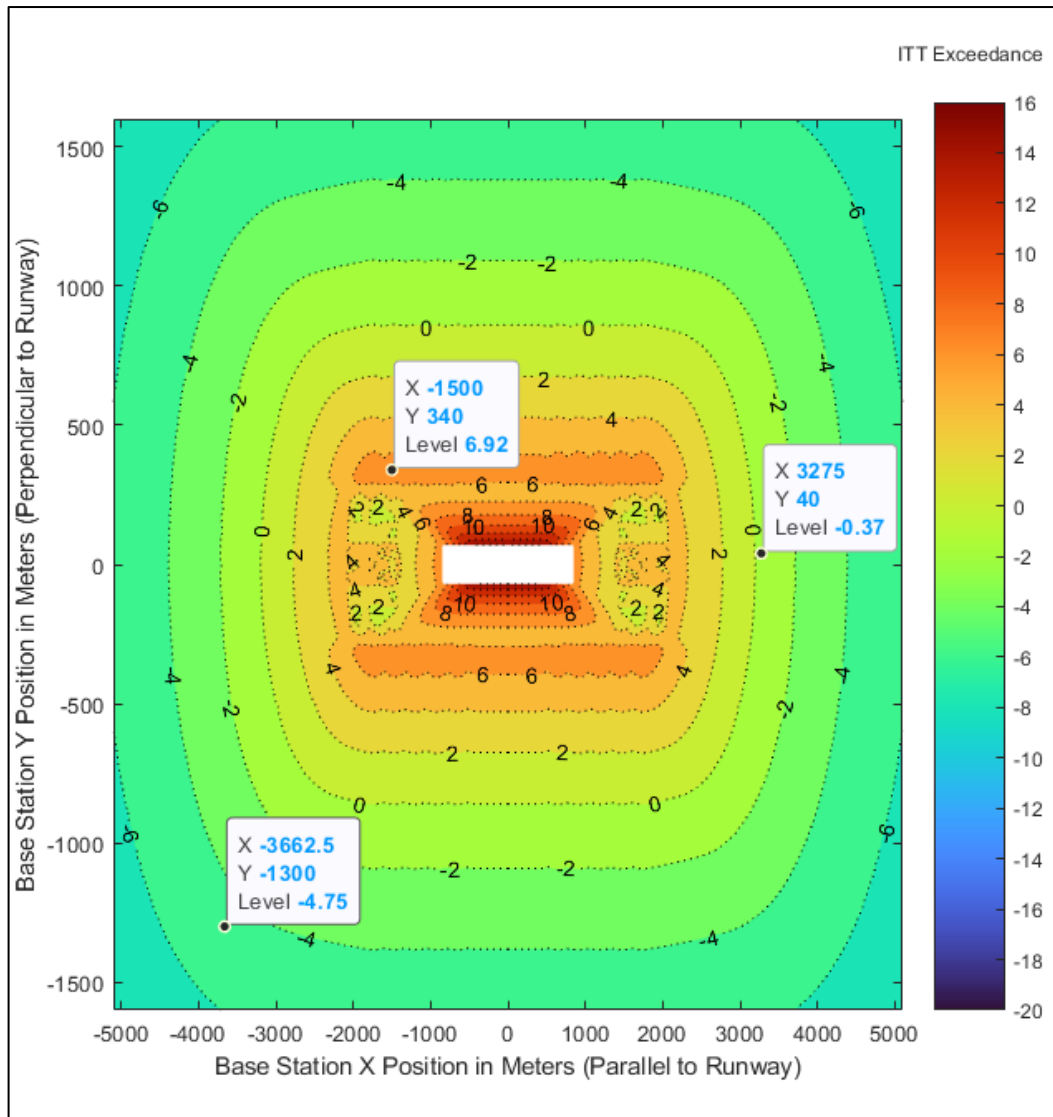

Figure 64: Example compatibility map output

A4.4 SUMMARY OF THE RESULTS

The results of this study are summarized in Table 37 through Table 44.

The results in the tables are presented in one of the following three formats:

- “Value1 x Value2, Value3”;
- “NI, Value4”;
- “Inc, Value5”.
- An explanation of each of the formats is provided below:
- The “Value1 x Value2, Value3” result indicates that the Radio Altimeter ITT was calculated to be exceeded by any amount at nearly all points bounded within the area defined by “Value1” metres beyond the edge of the runway in the length or x direction and “Value2” metres beyond the runway centreline in the width or y direction. The reported “Value1” result is normalized for all possible runway length assumptions.¹⁷

¹⁷ Resulting compatibility maps using two arbitrary sets of inputs that are identical except for the runway length parameter yield results that are only different by a translational factor in the x direction equal to the difference of half the runway lengths. For illustrative

The “Value2” result is similarly normalised for all possible runway width assumptions. The “Value3” result is the calculated amount of power exceeding the ITT for the MFCN BS and aircraft configuration resulting in the highest ITT exceedance within the bounds specified by “Value1 by Value2”. “Value3” is reported negative in value.

- The “NI, Value4” result indicates there was no interference calculated using the assumptions. In other words, every point in the three-dimensional grid analysed resulted in a RA ITT margin exceedance of 0 or less. The “Value4” result is the calculated amount of margin for the least compatible configuration against the ITT of the studied altimeter considering all base station locations assessed. “Value4” is reported positive in value;
- The “Inc” in the “Inc Value5” result stands for Inconclusive. The “Inc, Value5” result will only apply to RAs whose ITT value is indicated as NB (see section 4.3.2). “Inc” indicates that this study was performed using the maximum 5G signal level tested for the model indicated with NB, but there was insufficient data available to draw any valid conclusion. The “Value5” result is the calculated amount of power exceeding the ITT for the MFCN BS and aircraft configuration resulting in the highest ITT exceedance. “Value5” will be reported negative in value indicating the ITT was calculated to be exceed by the reported amount, but this result is not indicative of an actual interference condition.
- For example, if an RA model did not observe a breakpoint in testing yet the highest power tested was -20 dBm/MHz, then this study is performed using the -20 dBm/MHz value. If the study output indicates there will be interference, this is an “Inc, Value5” result because no actual breakpoint was observed. However, if the study indicates there is no interference, the result is conclusive and reported as “NI, Value4”.

Table 37: 3.4-3.7 GHz Radio Altimeter ITT Set 1 and Radio Altimeter Antenna Set 1 Combination Summary Table

Summary of Results for 3.4-3.7 GHz Radio Altimeter ITT Set 1 and RA Antenna Set 1 Parameter Combination Study						
Assumption Tree		RA ITT Model Specific Set 1 Parameters (Note1)				
MFCN Antenna Radiation Pattern	RA Height Interpolation Method	F	L	T	X	U
Extended AAS Model: Baseline	Stair-Step	NI, 8.9 dB	NI, 33.9 dB	NI, 8.7 dB	NI, 13.9 dB	NI, 8.7 dB
	Log-Linear	NI, 8.9 dB	NI, 33.9 dB	NI, 8.7 dB	NI, 13.9 dB	NI, 8.7 dB
Extended AAS Model: Baseline with vertical coverage range deviation	Stair-Step	NI, 7.0 dB	NI, 32.0 dB	NI, 6.8 dB	NI, 12.0 dB	NI, 6.8 dB
	Log-Linear	NI, 7.0 dB	NI, 32.0 dB	NI, 6.8 dB	NI, 12.0 dB	NI, 6.8 dB
Isotropic equivalent 58 dBm/MHz <i>e.i.r.p.</i>	Stair-Step	4580 m by 65 m, -11.8 dB	NI, 15.1 dB	Inc, -10.1 dB	Inc, -4.9 dB	Inc, -10.1 dB
	Log-Linear	4250 m by 50 m, -9.9 dB	NI, 15.1 dB	Inc, -10.1 dB	Inc, -4.9 dB	Inc, -10.1 dB

Note 1: No data was available to perform a study with Altimeter Model Y and therefore no result is provided.

purposes, if the study assumes a runway length of 1200 meters and the compatibility map indicates ITT exceedance 2200 meters offset in the x direction, and if the study assumes a runway length of 2400 metres and the compatibility map indicates ITT exceedance 2800 meters offset in the x direction, then the results in the summary table would be reported as “1600 x 600” because this normalizes the results. It is acknowledged that airports serving commercial air transport airplanes typically have much longer runways than 1200 metres. However, since the results are normalized, the runway length assumption in this study will not alter the reported result.

Table 38: 3.4-3.7 GHz Radio Altimeter ITT Set 1 and Radio Altimeter Antenna Set 2 Combination Summary Table

Summary of Results for 3.4-3.7 GHz RA ITT Set 1 and RA Antenna Set 2 Parameter Combination Study						
Assumption Tree		RA ITT Model Specific Set 1 Parameters (Note 1)				
MFCN Antenna Radiation Pattern	RA Height Interpolation Method	F	L	T	X	U
Extended AAS Model: Baseline	Stair-Step	350 m by 180 m, -2.4 dB	NI, 22.6 dB	Inc, -2.6 dB	NI, 2.5 dB	Inc, -2.6 dB
	Log-Linear	340 m by 180 m, -2.4 dB	NI, 22.6 dB	Inc, -2.6 dB	NI, 2.6 dB	Inc, -2.6 dB
Extended AAS Model: Baseline with vertical coverage range deviation	Stair-Step	520 m by 180 m, -4.8 dB	NI, 20.2 dB	Inc, -5.0 dB	Inc, -0.2 dB	Inc, -5.0 dB
	Log-Linear	520 m by 180 m, -4.8 dB	NI, 20.2 dB	Inc, -5.0 dB	Inc, -0.2 dB	Inc, -5.0 dB
Isotropic equivalent 58 dBm/MHz <i>e.i.r.p.</i>	Stair-Step	6250 m by 255 m, -18.6 dB	NI, 6.4 dB	Inc, -18.8 dB	Inc, -13.6 dB	Inc, -18.8 dB
	Log-Linear	6200 m by 195 m, -18.6 dB	NI, 6.4 dB	Inc, -18.8 dB	Inc, -13.6 dB	Inc, -18.8 dB

Note 1: No data was available to perform a study with Altimeter Model Y and therefore no result is provided.

Table 39: 3.7-3.8 GHz Radio Altimeter ITT Set 1 and Radio Altimeter Antenna Set 1 Combination Summary Table

Summary of Results for 3.7-3.8 GHz RA ITT Set 1 and RA Antenna Set 1 Parameter Combination Study							
Assumption Tree		RA ITT Model Specific Set 1 Parameters					
MFCN Antenna Radiation Pattern	RA Height Interpolation Method	F	L	T	X	U	Y
Extended AAS Model: Baseline	Stair-Step	NI, 0.2 dB	NI, 34.1 dB	NI, 9.1 dB	NI, 14.1 dB	NI, 9.1 dB	NI, 1.1 dB
	Log-Linear	NI, 0.2 dB	NI, 34.1 dB	NI, 9.1 dB	NI, 14.1 dB	NI, 9.2 dB	NI, 1.1 dB
Extended AAS Model: Baseline with vertical coverage range deviation	Stair-Step	920 m by 20 m, -1.8 dB	NI, 32.2 dB	NI, 7.2 dB	NI, 12.2 dB	NI, 7.2 dB	820 m by 15 m, -0.8 dB
	Log-Linear	920 m by 20 m,	NI, 32.2 dB	NI, 7.2 dB	NI, 12.2 dB	NI, 7.2 dB	820 m by 15 m,

Summary of Results for 3.7-3.8 GHz RA ITT Set 1 and RA Antenna Set 1 Parameter Combination Study							
		-1.8 dB					-0.8 dB
Isotropic equivalent 58 dBm/MHz <i>e.i.r.p.</i>	Stair-Step	6640 m by 200 m, -21.6 dB	NI, 15.3 dB	Inc, -9.7 dB	Inc, -6.5 dB	Inc, -9.7 dB	6660 m by 200 m, -22.6 dB
	Log-Linear	6640 m by 200 m, -18.7 dB	NI, 15.3 dB	Inc, -9.7 dB	Inc, -4.7 dB	Inc, -9.7 dB	6660 m by 200 m, -17.7 dB

Table 40: 3.7-3.8 GHz Radio Altimeter ITT Set 1 and Radio Altimeter Antenna Set 2 Combination Summary Table

Summary of Results for 3.7-3.8 GHz RA ITT Set 1 and RA Antenna Set 2 Parameter Combination Study							
Assumption Tree		RA ITT Model Specific Set 1 Parameters					
MFCN Antenna Radiation Pattern	RA Height Interpolation Method	F	L	T	X	U	Y
Extended AAS Model: Baseline	Stair-Step	2360 m by 760 m, -11.2 dB	NI, 22.8 dB	Inc, -2.2 dB	NI, 2.8 dB	Inc, -2.2 dB	2560 m by 840 m, -10.2 dB
	Log-Linear	1610 m by 500 m, -11.2 dB	NI, 22.8 dB	Inc, -2.2 dB	NI, 2.8 dB	Inc, -2.2 dB	1240 m by 440 m, -10.2 dB
Extended AAS Model: Baseline with vertical coverage range deviation	Stair-Step	3170 m by 760 m, -13.5 dB	NI, 20.5 dB	Inc, -4.5 dB	NI, 0.5 dB	Inc, -4.5 dB	3480 m by 840 m, -12.5 dB
	Log-Linear	2500 m by 500 m, -13.5 dB	NI, 20.5 dB	Inc, -4.5 dB	NI, 0.5 dB	Inc, -4.5 dB	2380 m by 440 m, -12.5 dB
Isotropic equivalent 58 dBm/MHz <i>e.i.r.p.</i>	Stair-Step	7190 m by 800 m, -27.4 dB	NI, 6.7 dB	Inc, -18.4 dB	Inc, -13.5 dB	Inc, -18.4 dB	7280 m by 880 m, -27.3 dB
	Log-Linear	7190 m by 750 m, -27.4 dB	NI, 6.7 dB	Inc, -18.4 dB	Inc, -13.5 dB	Inc, -18.4 dB	7280 m by 820 m, -26.4 dB

Table 41: 3.4-3.8 GHz Radio Altimeter ITT Set 2 and Radio Altimeter Antenna Set 2 Combination Summary Table

MFCN Antenna Radiation Pattern	RA ITT Set 2 and RA Antenna Set 2 Parameters Using Stair-Step Interpolation Method Result
Extended AAS Model: Baseline	4740 m by 1540 m, -12.6 dB (Note1) (Note2) (Note3)
Extended AAS Model: Baseline with vertical coverage range deviation	5780 m by 1540 m, -16.5 dB

MFCN Antenna Radiation Pattern	RA ITT Set 2 and RA Antenna Set 2 Parameters Using Stair-Step Interpolation Method Result
Isotropic equivalent 58 dBm/MHz <i>e.i.r.p.</i>	7940 m by 1640 m, -32.3 dB
<p>Note 1: If the ITT is not extrapolated to below 200 ft and the base station height is limited to 35 m, then the result is 4740 m by 1540 m, -10.1 dB.</p> <p>Note 2: If the ITT is not extrapolated to below 200 ft and the base station height is limited to 35 m and the interpolation method is Log-Linear, then the result is 3480 m by 480 m, -4.6 dB.</p> <p>Note 3: If the ITT is strictly assessed at 200 ft and 1000 feet and the base station height is limited to 35 m, then the result is 1660 m by 480 m, -0.1 dB.</p>	

Table 42: 4.2-4.4 GHz Radio Altimeter ITT Set 1 and Radio Altimeter Antenna Set 1 Combination Summary Table

Assumption Tree		RA ITT Model Specific Set 1 Parameters					
MFCN Antenna Radiation Pattern	RA Height Interpolation Method	F	L	T	X	U	Y
Isotropic equivalent (-30 dBm/MHz <i>e.i.r.p.</i>)	Stair-Step	NI, 13.0 dB	NI, 17.1 dB	NI, 26.3 dB	NI, 5.7 dB	NI, 72.2 dB	NI, 14.1 dB
	Log-Linear	NI, 24.2 dB	NI, 17.1 dB	NI, 31.2 dB	NI, 19.3 dB	NI, 72.2 dB	NI, 26.6 dB
Isotropic equivalent (-13 dBm/MHz <i>e.i.r.p.</i>)	Stair-Step	2340 m by 10 m, -3.9 dB	NI, 0.1 dB	NI, 9.3 dB	5260 m by 60 m, -11.3 dB	NI, 72.2 dB	2140 m by 10 m, -2.9 dB
	Log-Linear	NI, 3.4 dB	NI, 0.1 dB	NI, 14.2 dB	NI, 2.3 dB	NI, 55.2 dB	NI, 9.6 dB

Table 43: 4.2-4.4 GHz Radio Altimeter ITT Set 1 and Radio Altimeter Antenna Set 2 Combination Summary Table

Assumption Tree		RA ITT Model Specific Set 1 Parameters					
MFCN Antenna Radiation Pattern	RA Height Interpolation Method	F	L	T	X	U	Y
Isotropic equivalent (-30 dBm/MHz <i>e.i.r.p.</i>)	Stair-Step	NI, 8.6 dB	NI, 12.6 dB	NI, 21.8 dB	NI, 1.7 dB	NI, 67.8 dB	NI, 9.6 dB
	Log-Linear	NI, 20.4 dB	NI, 12.6 dB	NI, 26.8 dB	NI, 16.2 dB	NI, 67.8 dB	NI, 22.9 dB
Isotropic equivalent (-13 dBm/MHz <i>e.i.r.p.</i>)	Stair-Step	3160 m by 85 m, 8.4 dB	2260 m by 40 m, -4.4 dB	NI, 4.8 dB	6740 m by 275 m, -15.3 dB	NI, 50.8 dB	2860 m by 75 m, -7.4 dB
	Log-Linear	NI, 3.4 dB	2260 m by 40 m, -4.4 dB	NI, 9.8 dB	6740 m by 100 m, -7.4 dB	NI, 50.8 dB	NI, 5.9 dB

Table 44: 4.2-4.4 GHz Radio Altimeter ITT Set 2 and Radio Altimeter Antenna Set 2 Combination Summary Table

MFCN Antenna Radiation Pattern	RA ITT Set 2 and RA Antenna Set 2 Parameters Using Stair-Step Interpolation Method Result
Isotropic equivalent (-30 dBm/MHz <i>e.i.r.p.</i>)	NI, 13.1 dB
Isotropic equivalent (-13 dBm/MHz <i>e.i.r.p.</i>)	2360 m by 15 m, -3.9 dB

A4.5 ASSUMPTIONS SUMMARY

Assumptions used in the study:

- The AAS antenna is positioned at a height based upon the minimum of 35 m and the OLS;
- The AAS antenna is not paced at heights less than 10 m.
- The MFCN base station assumptions are made:
 - All base stations are constrained to a 58 dBm/MHz *e.i.r.p.* limit;
 - All base stations assume a 3-degree mechanical downtilt at any installation height.
- Three AAS radiation patterns are considered:
 - The 'baseline MFCN antenna pattern' described in section A4.2 list index #1;
 - The 'baseline MFCN antenna pattern with vertical coverage range deviation' described in section A4.2 list index #2;
 - Deviation considering an extended vertical coverage range of 0 to 26 degrees for all antenna locations;
 - The 'isotropic equivalent' MFCN antenna pattern,' described in section A4.2 list index #3.
 - Assumes that spectrum regulators may not place any regulatory requirements on base station pointing, equating to an isotropic equivalent gain of 26 dBi resulting in an isotropic equivalent *e.i.r.p.* of 58 dBm/MHz.
- The RA is assumed to be located anywhere at or above the minimum glide slope surface.
- A single set of breakpoint extrapolation methods are considered for heights which a breakpoint is not specified:
 - From 0 feet up to 200 feet, the breakpoint is assumed to be equivalent to the value at 200 feet;
 - For heights greater than 1000 feet, no breakpoint is assumed.
- Two breakpoint interpolation methods are considered for heights which a breakpoint is not specified:
 - The first approach assumes a stair-step method in which the breakpoint value at 1000 feet is applied for all heights down until 200 feet;
 - The second approach assumes a log-linear method in which a straight line on a log-linear plot is drawn between the breakpoint at 1000 feet and the other breakpoint value height;
- The results include the ICAO safety margin of 6 dB.

A4.6 CONCLUSIONS

The results of this study vary significantly depending on the combinations of assumptions, the primary conclusions are reported below.

When considering all RA ITTs and antenna parameters and both studied interpolation methods, for MFCN systems operating in the frequency band 3.4-3.8 GHz,

- 1 using the baseline MFCN AAS antenna pattern, an exclusion area bounded by 4740 m beyond the runway threshold and 1540 m beyond the runway centreline is necessary to ensure protection of all studied RA systems;
- 2 using the baseline MFCN AAS antenna pattern with vertical coverage range deviation of 0 to 26 degrees, an exclusion area bounded by 5780 m beyond the runway threshold and 1540 m beyond the runway centreline is necessary to ensure protection of all studied RA systems;
- 3 using the isotropic equivalent MFCN AAS antenna pattern with a gain of 26 dBi, an exclusion area bounded by 7940 m beyond the runway threshold and 1640 m beyond the runway centreline is necessary to ensure protection of all studied RA systems;

- 4 spurious emissions limited to a -30 dBm/MHz *e.i.r.p.* yielded results that indicated that no interference for all possible combinations of assumptions;
- 5 When considering RA model specific results, for MFCN systems operating in the frequency band 3.4-3.8 GHz;
- 6 RA model L was found to experience no interference for all possible combinations of assumptions including MFCN AAS antenna patterns beyond baseline;
- 7 RA model Y had no data available to draw conclusions on compatibility;
- 8 RA models T, X, and U had insufficient data available to draw conclusions on compatibility;
- 9 Applying an exclusion area smaller than the area specified for conclusions 1.1, 1.2, and 1.3 results in conditions where:
 - 10 interference to the RA from MFCN emissions is realized for at least one combination of assumptions, or
 - 11 there is insufficient information available to draw a valid conclusion;
 - 12 Conclusion 1.3 would protect all RAs currently in operation.

ANNEX 5: (STUDY D) SIMULATION RESULTS FOR RADIO ALTIMETER 4200-4400 MHZ COEXISTENCE WITH MFCN OPERATED IN 3400-3800 MHZ WITH RADIO ALTIMETER PARAMETER SET 1

A5.1 SUMMARY

For the base station locations and operational scenarios studied, the results indicate, when an aircraft is at 200 feet and 1000 feet, that coexistence is feasible between MFCN and Radio Altimeters with positive margins considering the Obstacle Limitation Surface (OLS) that are defined for airports. The minimum found margin, which is for interference due to blocking of the RA receiver from the 3.4-3.8 GHz in-band emission of the MFCN and Radio Altimeter model F and Y at Radio Altimeter height 200 feet, is still >11 dB. More specifically:

- The spurious emission shows much larger margins compared to the blocking.
- The margins for 1000 feet are higher than for the 200 feet Radio Altimeter height.
- The highest IMT signal level at the Radio Altimeter is from BSs located within the approach surface below the OLS and when located approximately below the Radio Altimeter.
- BS heights of 20 m / 25 m / 35 m were used in the study. Due to OLS this maintains a minimum separation distance from the edge of the runway meaning that at lower altimeter heights (<200 feet) the aircraft is never directly over the BS.
- This deployment assumption (OLS, BS height) safeguards the Radio Altimeter also for altimeter heights below 200 feet from possible IMT BS interference within the Approach and Transitional surface (Δx , Δy BS positions)
- Pitch and roll for higher altimeter heights and for the case with BS below the Radio Altimeter will increase and shift the location of the maximum IMT signal observed over a small area.

Replacing altimeter model F and Y in airplanes with other models e.g. model X, L or retrofitted with additional filters would give higher margins.

The margins in this study consider the ITT values with tolerance as defined in section 4.3.2. The least resilient Radio Altimeter model from Set 1 is considered. The 6 dB ICAO safety margin is not considered in the ITT values.

A5.2 SIMULATION ASSUMPTIONS

A5.2.1 BS location and obstacle limitation surface

As outlined in section 0 and ICAO Annex 14 [26], the obstacle limitation surface around the runway is specified for transitional-, inner horizontal- and the approach-surface, see Figure 7 to Figure 9. From this, the minimum distance of a BS from the runway (threshold for a specific BS height) can be calculated as given in Table 45 and indicated in Figure 65. The BS heights used in this study are given in Table 10. The airplane touchdown point is taken as the Reference Point (RP) in the simulation results. The runway safety area from the runway centre is taken with $az = 150$ m towards the Transitional surface and 60 m towards the Approach surface. The touchdown point from the runway edge is taken with $bx = 0$ m. This will be the tighter case for the BS and possible interference towards the Radio Altimeter. For the study the Δx direction in the Approach surface and the Δy direction in the transitional surface will be of main interest defining the minimum BS separation from the RP.

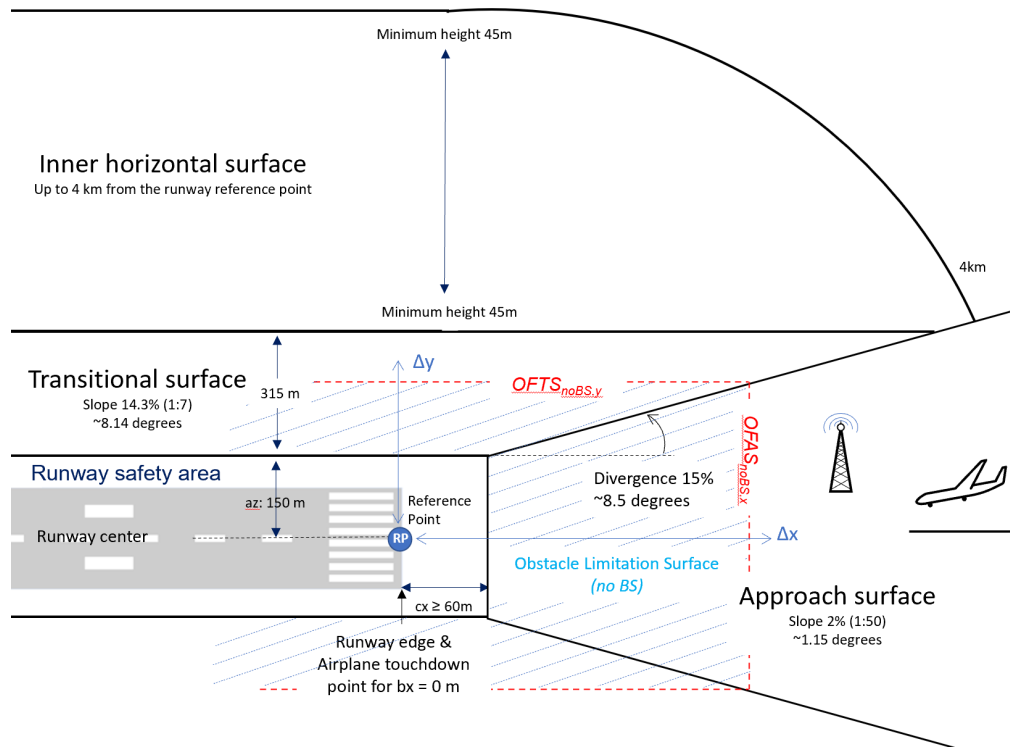

Figure 65: Obstacle limitation surfaces from runway and indicating the BS free zone from the Reference Point (RP) as a function of OLS and BS height.

Table 45: Obstacle Free distance as a function of OLS and BS height for (i) Δx along the Approach Surface (named $OFAS_{noBS,x}$) from runway edge (RP) and with (ii) Δy within the Transitional Surface orthogonal to the runway (named $OFTS_{noBS,y}$) from runway centre (RP)

	$OFAS_{noBS,x}$ from runway edge (BS below OLS along the x-axis)	$OFTS_{noBS,y}$ from runway centre (BS below OLS along the y-axis)
BS height 35 m (macro-rural)	1.81 km	0.395 km
BS height 25 m (macro-suburban)	1.31 km	0.325 km
BS height 20 m (macro-urban)	1.06 km	0.29 km

A5.2.2 Simulation scenarios and parameters

The study is done considering the following parameters and scenarios.

Radio Altimeter/Aircraft:

- Airplane glideslope with 3 degrees and for sensitivity/parametric analysis with ± 0.375 degrees variation which can give a closer/shorter distance between altimeter and IMT BS for the same distance from the runway;
- Altimeter height 200 and 1000 feet as agreed for the breakpoints;
- Altimeter antenna model as given in Table 9 in section 4.3.4.1;
- Assuming roll up to ± 15 degrees for altimeter heights 200 and 1000 feet. For sensitivity/parametric analysis roll/pitch with 0 degree;
- 3 dB cable loss and 3 dB polarisation loss.

IMT BS with AAS:

- Macro BS heights as defined in Table 10;
- BS distance (Δx , Δy) from RP within Approach surface ($>OFAS_{noBS,x}$) and Transitional surface ($>OFTS_{noBS,y}$) as given in Table 45;
- BS sector horizontal boresight always pointing towards altimeter for every BS_{xy} position (worst-case assumption). For AAS the simulation considers from all possible beamforming angles within the vertical coverage range the worst-case situation towards the Radio Altimeter;
- For the 3.4-3.8 GHz macro IMT BS the parameters as given in Table 10, Table 12 and Table 13 are used in the simulation (sub-array AAS antenna, BS vertical coverage range 0 to -10 degrees, etc.). The macro-BS power with 82 dBm/100 MHz *e.i.r.p.* is used in the study.

Interference scenarios:

- The values are computed for IMT centre frequency at 3.6 GHz;
- OOB blocking level at altimeter with fully correlated beamformed IMT antenna gain (max 26.2 dBi). Altimeter OOB peak antenna gain with 0 dBi (The antenna for the in-band case (4.2-4.4 GHz) is modelled using Report ITU-R M.2319 with peak gain and 3 dB beam width based on RTCA Paper No. 274-20/PMC-2073 [25]. For the out-of-band/adjacent channels, the same antenna pattern is used, see Table 9.
- Table 8);
- Spurious emission level at the altimeter with uncorrelated beamforming considering sub-array antenna gain of ~11.2 dBi (see [29], Annex 20). Altimeter in-band peak antenna gain with 9 dBi (The antenna for the in-band case (4.2-4.4 GHz) is modelled using Report ITU-R M.2319 with peak gain and 3 dB beam width based on RTCA Paper No. 274-20/PMC-2073 [25]. For the out-of-band/adjacent channels, the same antenna pattern is used, see Table 9.
- Table 8).

The worst-case interference values as a function of BS antenna heights, AAS beamforming, BS position, Radio Altimeter position, etc. is calculated. In section A6.2.3 (for the 3.8-4.2 GHz band) such worst-case study without probability is further discussed and the same findings could be applied to the 3.4-3.8 GHz study.

A5.2.3 Simulation results

A5.2.4 Macro BS in 3.4-3.8 GHz band and Radio Altimeter at 200 and 1000 feet

A5.2.4.1 Contour plots for radio Altimeter at 200 feet height

Figure 66, Figure 67 and Figure 69 show the contour plot with the maximum interference levels for OOB blocking and spurious emission in dBm/MHz, respectively, at the Radio Altimeter receiver from the corresponding Δx , Δy BS location from the Reference Point (RP) as outlined in Figure 65. The result is for aircraft at 200 feet (1163, 0, 61) and for roll up to ± 15 degrees. For macro urban case and BS positions below the obstacle limitation surface ($\Delta x > 1.06$ km, $\Delta y > 0.29$ km in Table 45). It can be seen from the figures:

- The maximum value of the OOB blocking is -46.4 dBm/MHz (Table 46) and the region where the larger fluctuation is observed is from Δx : 1.06 km to 1.3 km and Δy : 0 to ± 0.1 km on the Approach surface. This is also shown in Figure 68 with OOB blocking levels as a function of Δx in meters (BS locations) and for Δy offset with 0 meters;
- The OOB blocking level at the Radio Altimeter Rx for the BSs within the Transitional Surface are < -72 dBm/MHz;
- The maximum observed value for this case is more than 11 dB below the lowest Interference Tolerance Threshold (ITT) level, which corresponds to Altimeter model Y in Table 51;
- The maximum interference value at the altimeter due to the spurious emission is -113.6 dBm/MHz and the region of the larger fluctuation (-117 to -136 dBm/MHz) in spurious emission values is in the Approach surface similar as observed for the OOB blocking;
- The interference level at the Radio Altimeter Rx due to spurious emission for the BSs within the Transitional Surface is < -132 dBm/MHz;
- The max observed spurious emission level for this case is more than 32 dB below the lowest Interference Tolerance Threshold (ITT) level, which corresponds to Altimeter model L in Table 53.

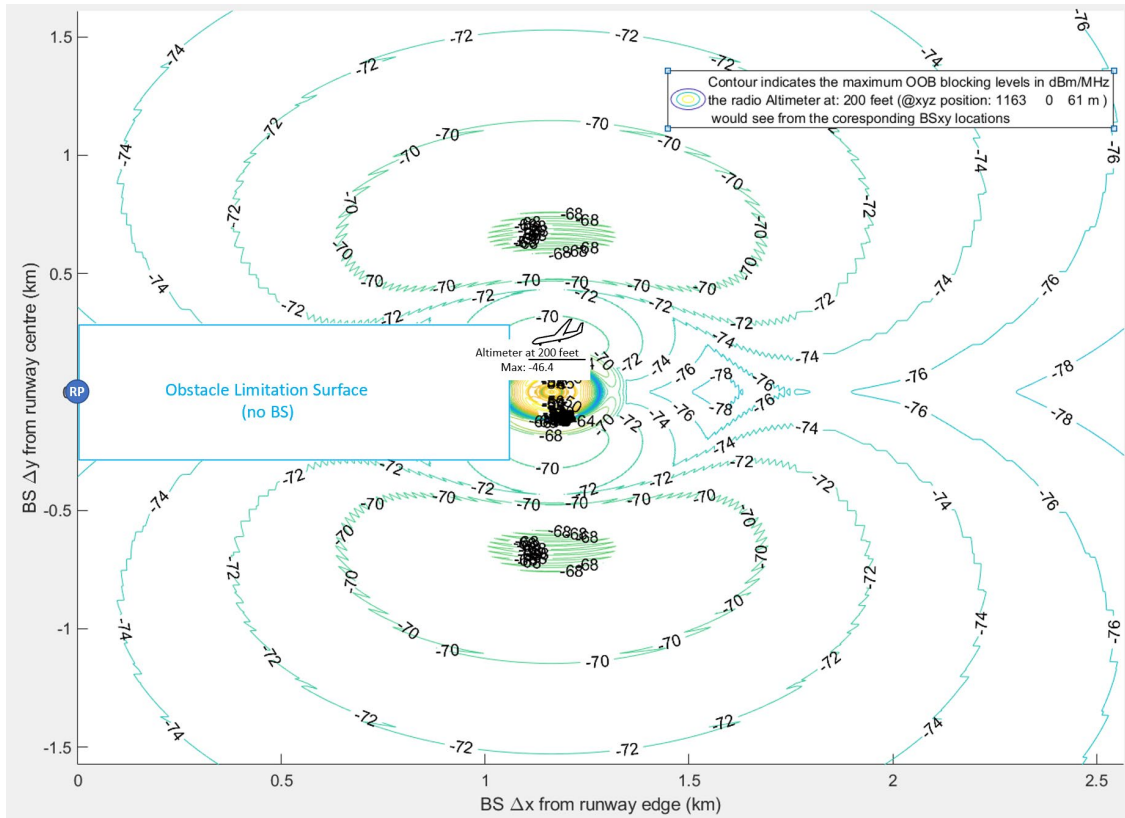

Figure 66: Contour plot showing the maximum OOB blocking levels in dBm/MHz the Altimeter would see from the corresponding Δx , Δy BS location from the RP. The result is for Altimeter at 200 feet (1163,0, 61) and with up to ± 15 degrees roll. For macro urban AAS BS with 20 m height

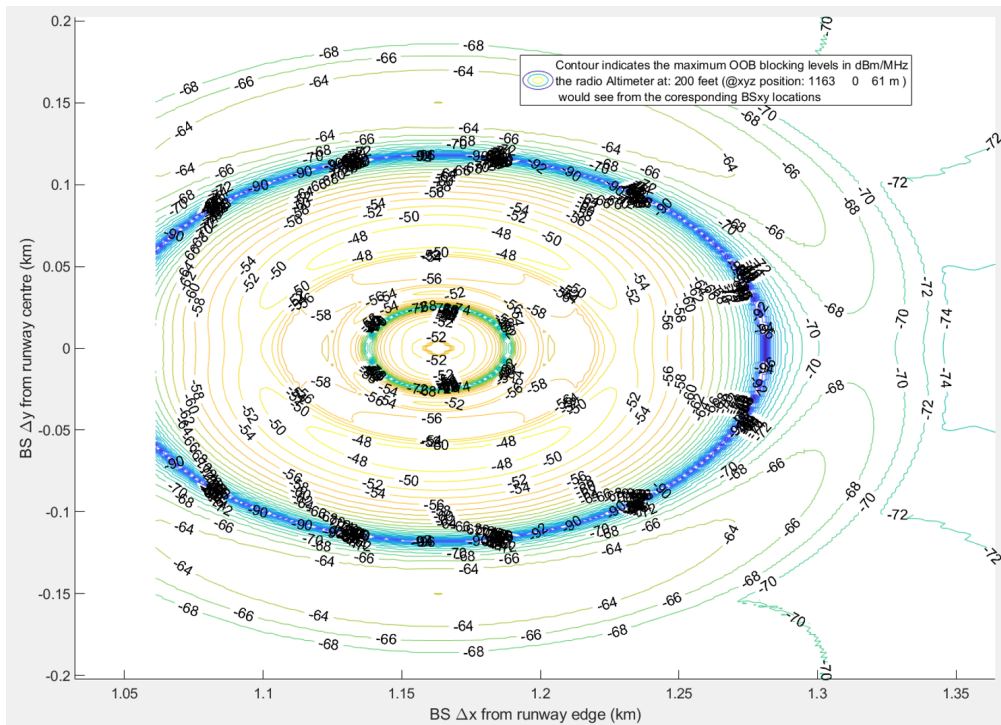

Figure 67: Contour plot for same case as shown in Figure 66 showing enlarged the region of the BSs below Radio Altimeter where larger sharp fluctuation is observed

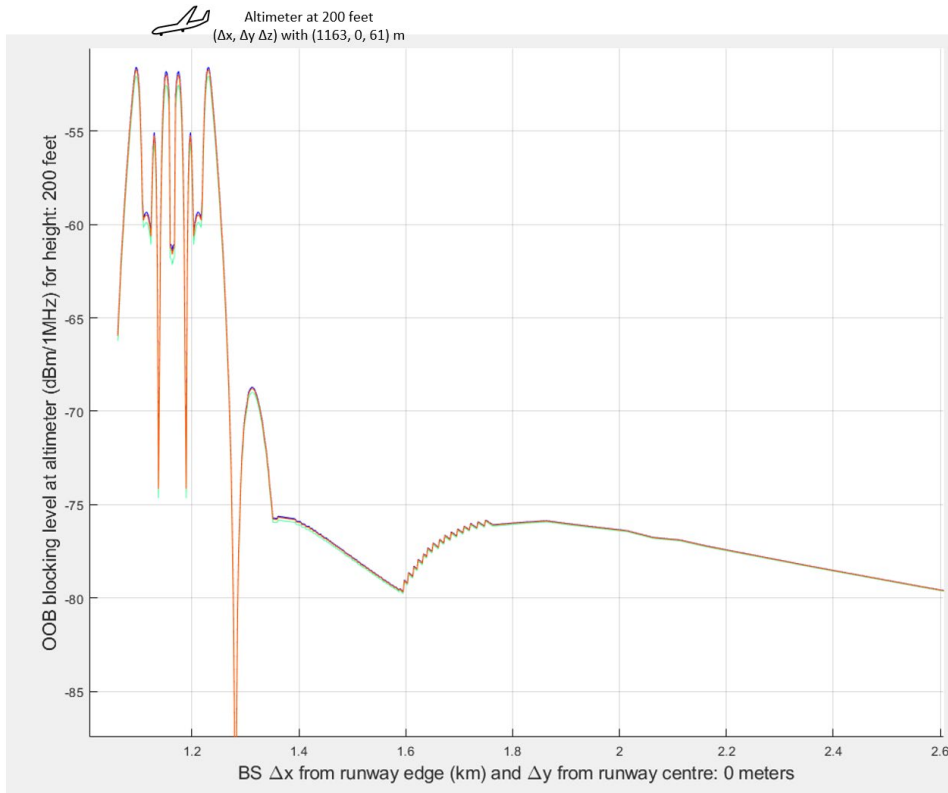

Figure 68: OOB blocking levels as a function of Δx (BS locations) for Δy offset 0 meters in Figure 66. The peak value for the OOB blocking level with -46.4 dBm/MHz in Figure 66 is at $\Delta y = \pm 67$ meters

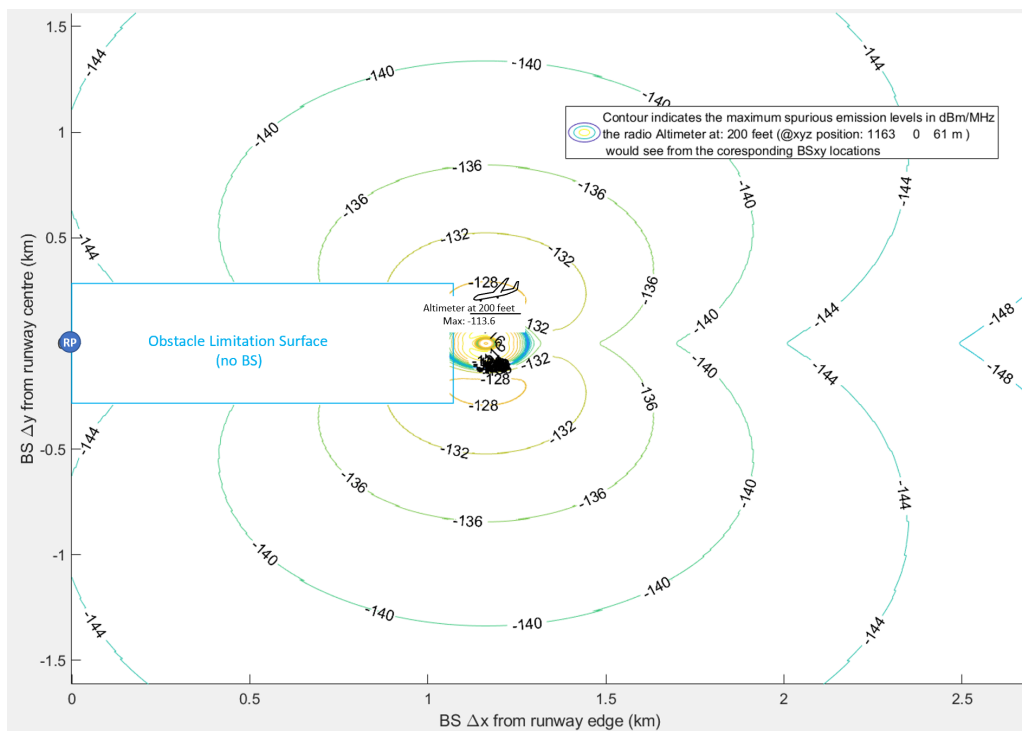

Figure 69: Contour plot showing the maximum spurious emission levels in dBm/MHz the Altimeter would see from the corresponding $\Delta x, \Delta y$ BS location from the RP. The result is for Altimeter at 200 feet (1163, 0, 61) and with up to ± 15 degrees roll. For macro urban AAS BS with 20 m height

A5.2.4.2 Contour plots for Radio Altimeter at 1000 feet height

Figure 70 shows the OOB blocking levels for a Radio Altimeter at 1000 feet height and for increasing BS location Δx from the Reference Point (RP) below the obstacle limitation surface ($OFAS_{noBS,x}$) at fixed offset with $\Delta y = 0$ meters and for roll up to ± 15 degrees. Figure 71 and Figure 72 show the contour plot for the maximum OOB blocking and maximum spurious emission levels, respectively, the Radio Altimeter would see from the BS_{xy} position for roll up to ± 15 degrees. From the results, it can be seen:

- The highest values with sharper peaks (over short distances) are observed when the BS is about below the airplane. The altimeter height 1000 feet is at $\Delta x = 5816$ meters from the RP. The reason for such higher peaks in the interference is because the pathloss between IMT BS and Altimeter is at its lowest at that point;
- The highest peak OOB blocking value for the case with $\Delta y = 0$ meters offset is ~ -66 dBm/MHz (Figure 70). Looking at the contour plot it can be found that the max peak with -62.8 dBm/MHz is at $\Delta x = \sim 5.8$ km and at $\Delta y = \sim 0.3$ km (Figure 71);
- The max observed OOB blocking value for this case (macro rural) is more than 25 dB below the lowest ITT level, which corresponds to Altimeter model Y in Table 52;
- The maximum observed spurious emission level is -128.7 dBm/MHz (Figure 72). This is more than 43 dB below the lowest ITT level, which corresponds to Altimeter model F in Table 53.

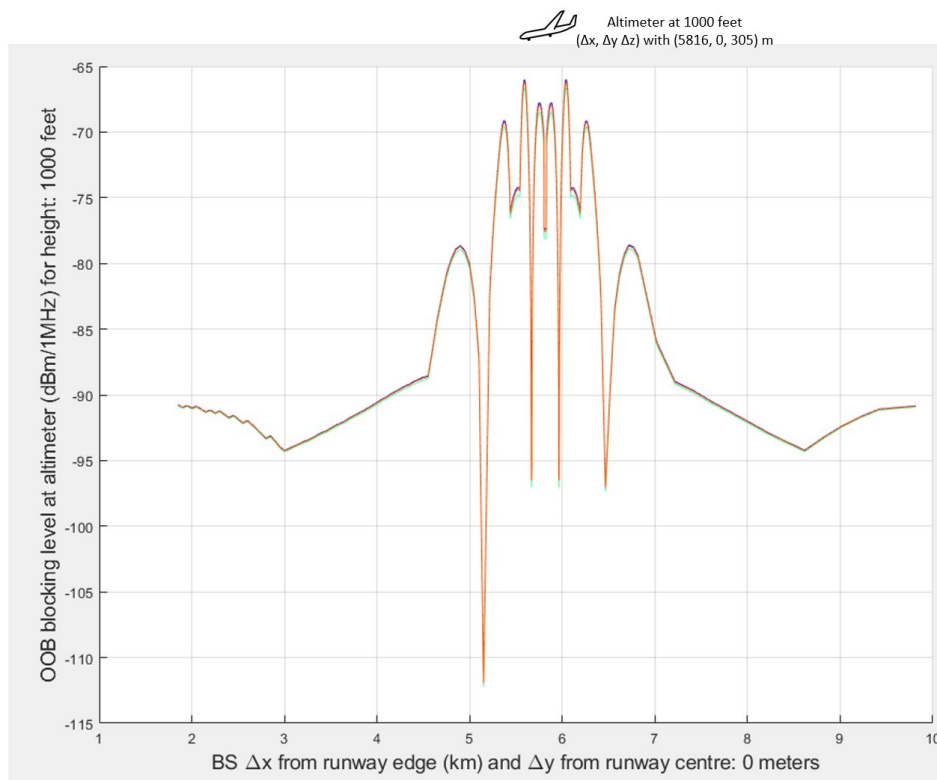

Figure 70: Maximum OOB blocking levels in dBm/MHz as a function of Δx BS locations and for $\Delta y = 0$ meters offset from the RP. For Radio Altimeter at 1000 feet (5816, 0, 305), and with up to ± 15 degrees roll. For macro rural AAS BS with 35 m height

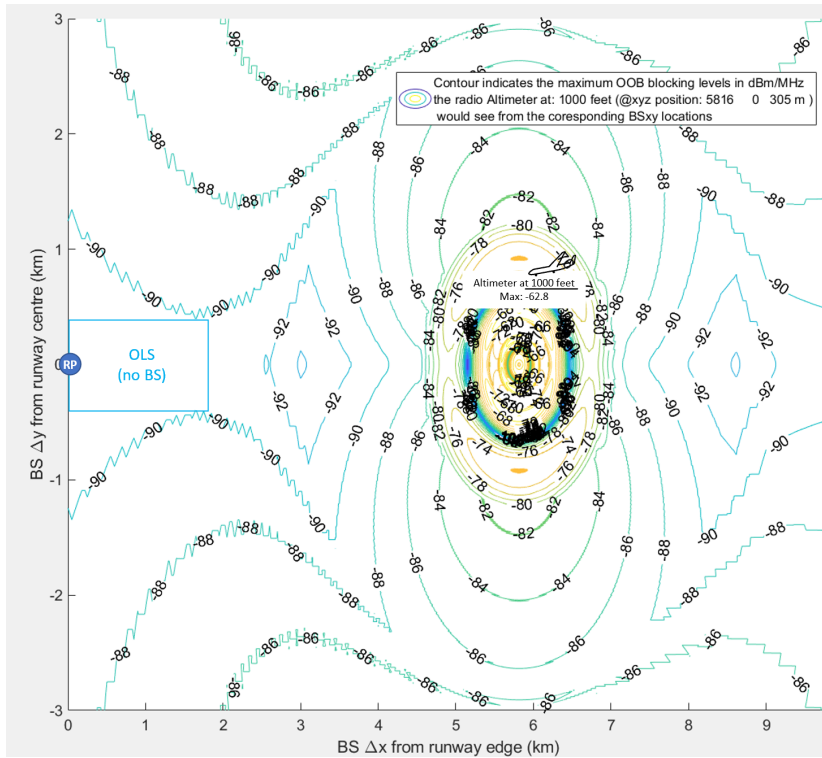

Figure 71: Contour plot showing the maximum OOB blocking levels in dBm/MHz the Altimeter would see from the corresponding Δx , Δy BS location from the RP. The result is for Altimeter at 1000 feet (5816, 0, 305) and with up to ± 15 degrees roll. For macro rural AAS BS with 35 m height

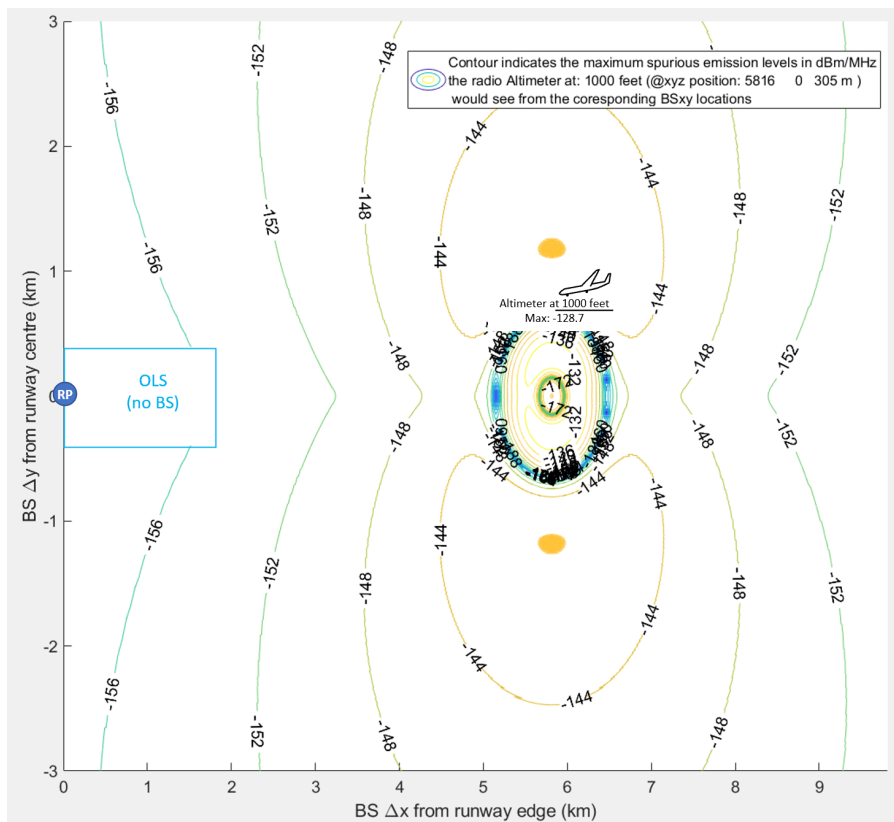

Figure 72: Contour plot showing the maximum spurious emission levels in dBm/MHz the Altimeter would see from the corresponding Δx , Δy BS location from the RP. The result is for Altimeter at 1000 feet (5816, 0, 305) and with up to ± 15 degrees roll. For macro urban AAS BS with 35 m height

A5.2.4.3 Tables with maximum OOB blocking level results

Table 46 and Table 47 list the maximum OOB blocking levels for Altimeters at 200 feet ($\Delta x = 1.163$ km) and 1000 feet ($\Delta x = 5.816$ km) for 15 degree roll, rural, suburban and urban BS heights, BSs below the obstacle limitation surface and for centre frequency 3.6 GHz. For 3.4 or 3.8 GHz the result would change by about +0.5 dB, which is mainly due to free space pathloss difference. From Table 46 and Table 47, what follows can be concluded.

For 200 feet altimeter height in Table 46:

- The macro urban case gives the highest values, and this is because the maximum value is observed within the approach surface ($\Delta y = \sim \pm 80$ m) for the BS height of 20 meters.
- For the suburban and rural BS heights of 25 and 35 meters the highest OOB blocking level value is ~16 to ~20 dB below the value from the urban case and is mainly found within the transitional surface at $\Delta y > 0.325$ to 1.2 km. This is because for the Radio Altimeter height of 200 feet the macro, rural and suburban BS can not be below the Radio Altimeter, where the large/sharp fluctuation is observed, as this is above the obstacle limitation surface (see Table 45).

For 1000 feet altimeter height in Table 47:

- The values between macro-rural, sub-urban and urban cases differ by less than 1 dB. This is as the sharp peaks are observed when the BS is below the Radio Altimeter, see Figure 70, and in opposite to 200 feet, this is the case for urban, suburban, and rural BS height for the 1000 feet Radio Altimeter;
- The peak values are within the outer surface from $\Delta x = \sim 5.3$ to 6.3 km to $\Delta y = \pm 0.1$ to ± 0.6 km BS location with respect to the RP.

Table 46: Maximum OOB blocking levels at Radio Altimeter 200 feet height with roll up to ± 15 degrees, for macro AAS BS below the obstacle limitation surfaces

	Macro rural BS height 35 m	Macro suburban BS height 25 m	Macro urban BS height 20 m
Maximum OOB blocking level at altimeter	-62.5 dBm/MHz	-66.7 dBm/MHz	-46.4 dBm/MHz
Max value from BS at position (for max to (max-3 dB) range)	Δx : 0.7 to 1.6 km Δy : at ± 0.395 to ± 0.9 km	Δx : 0.6 to 1.8 km Δy : at ± 1.2 km	Δx : 1.1 to 1.3 km Δy : at ± 0.08 km

Table 47: Maximum OOB blocking levels at the Radio Altimeter at 1000 feet height with roll up to ± 15 degrees, for macro AAS BS below the obstacle limitation surfaces

	Macro rural BS height 35 m	Macro suburban BS height 25 m	Macro urban BS height 20 m
Maximum OOB blocking level at altimeter	-62.8 dBm/MHz	-63.1 dBm/MHz	-63.3 dBm/MHz
Max value from BS at position (for max to (max-3 dB) range)	Δx : 5.3 to 6.3 km Δy : ± 0.1 to ± 0.6 km	Δx : 5.3 to 6.3 km Δy : ± 0.6 km	Δx : 5.3 to 6.3 km Δy : ± 0.6 km

A5.2.5 Tables with maximum spurious emission level results

Table 48 and Table 49 give the maximum interference due to spurious emissions for Altimeters at 200 and 1000 feet for the rural, suburban and urban BS heights and for BSs outside the obstacle limitation surface with ± 15 degrees roll. The findings regarding maximum values below the obstacle limitation surface and when Radio Altimeter is above BS follows the findings as outlined above for the OOB blocking values with the Radio Altimeter at 1000 feet.

Table 48: Maximum spurious emission levels at Radio Altimeter 200 feet height with roll up to ± 15 degrees, for macro AAS BS below the obstacle limitation surface

	Macro rural BS height 35 m	Macro suburban BS height 25 m	Macro urban BS height 20 m
For uncorrelated beamforming	-128.1 dBm/MHz	-128 dBm/MHz	-113.6 dBm/MHz
Max value from BS at position (for max to (max-3 dB) range)	Δx : 0.8 to 1.5 km Δy : at ± 0.395 to ± 0.7 km	Δx : 0.9 to 1.5 km Δy : at ± 0.395 to ± 0.53 km	Δx : 1.1 to 1.3 km Δy : at ± 0.07 km

Table 49: Maximum spurious emissions levels at Radio Altimeter 1000 feet height with roll up to ± 15 degrees, for macro AAS BS below the obstacle limitation surface

	Macro rural BS height 35 m	Macro suburban BS height 25 m	Macro urban BS height 20 m
For uncorrelated beamforming	-128.7 dBm/MHz	-130.2 dBm/MHz	-130.4 dBm/MHz
Max value from BS at position (for max to (max-3 dB) range):	Δx : 5.4 to 6.3 km Δy : ± 0.5 km	Δx : 5.4 to 6.3 km Δy : ± 0.6 km	Δx : 5.4 to 6.3 km Δy : ± 0.6 km

A5.2.6 Additional parameter analysis for AAS to the worst-cases accumulation

A sensitivity/parametric analysis is done for additional/different parameters/settings used in section A5.2.3 to understand how much this could change the outcome in either direction:

- Roll with 0 degree at the 200 feet altimeter heights for which Breakpoints are defined;
- Airplane glideslope with 2.625 degrees including possible variation in landing slope (3 ± 0.375 degrees);
- Altimeter without polarisation loss;
- Interference analysis for altimeter heights <200 feet;
- Comparing Radio Altimeter Set 1 and Set 2 ITT values.

Table 50 gives, in dB, the difference in interference levels for the worst-cases found in Table 46 and Table 48 for Radio Altimeter height 200 feet. The sensitivity/parametric analysis is useful as a worst-case study without probabilities has been conducted here (see also section A6.2.3 for more discussion on this).

Table 50: Difference in interference to parameter used in section A5.2.3 for 200 feet Radio Altimeter height

Parameter	Difference in dB
Roll with 0 degree compared to roll up to ± 15 degrees	-3 to -8 dB (for peak value) Roll will shift the maximum observed peaks within the high fluctuation area which will mainly matter to Δy and the Transitional surface. Outside the high fluctuation area, the difference roll makes is less. Note: The peak will depend if BS can be in smaller area below Radio Altimeter which depends on OLS
Airplane glideslope with 2.625 degrees compared to 3 degrees	0 dB (for peak value) But max value observed at ~ 1.3 km Δx from RP compared to ~ 1.2 km for 3 degrees slope. Note: The peak will depend if BS can be in smaller area below Radio Altimeter

Parameter	Difference in dB
	which depends on OLS
Airplane touchdown point (RP)	Any difference in the Reference Point (RP) will shift the results in x or y direction by the difference in meters
Polarisation loss	+3 dB if altimeter uses linearly polarised receivers
BS in-block power	The power in dBm will shift linear in log-scale (dB) the interference level from OOB blocking

A5.2.6.1 Altimeter heights < 200 feet

Like the discussion in section A6.3.2 for medium power local area AAS BS the following two cases are considered:

- Case (a) with lowest BS height (from OLS) and Altimeter above the BS, giving shortest distance between BS and Radio Altimeter;
- Case (b) with Altimeter at ~66 feet. For the aircraft at the same height as the BS which is for Radio Altimeter at xyz-coordinates: 436, 0, 20 meters (Glideslope 2.625 degrees) and for zero-degree roll.

For Case (a) we can make conclusions from the results in the section above as this is the case for 20-meters BS height and Radio Altimeter at 200 feet (with 3 degrees glideslope), for which the BS can be located below the Radio Altimeter and being below the OLS. From the results above:

- For 200 feet Radio Altimeter heights the airplane position is (1163, 0, 61) meters in (x, y, z) coordinates from the RP for 3 degree glideslope;
- For macro urban BSs the shortest OFAS_{noBS,x} and OFTS_{noBS,y} is obtained (see Table 45). For the minimum macro BS heights of 20 meters the noBS region is (1060, 290) meters in (x, y) coordinates from the RP;
- The highest IMT signal level within the Approach surface and BS below the OLS occurs when the BS is in smaller area below the Radio Altimeter, this is as the free space pathloss is the lowest;
- OOB Blocking towards Radio Altimeter gives less margins compared to spurious emission.

For Case (a), the margin is still >11 dB for the worst performing Radio Altimeter (see Table 51).

For Case (b): Figure 73 shows the case with urban BS height and altimeter at same height (66 feet or 20 m). The obstacle limitation surface gives an OFTS_{noBS,y} with 290 meters from the runway centre (see Table 45). From the contour plot results, it can be seen that the maximum observed OOB blocking is -64 dBm/MHz (Figure 73). This value is much lower than the max value observed in Figure 66 or Table 46 for 200 feet altimeter height. Therefore, an altimeter at around 200 feet height covers the worst-case of interference. This finding can be explained as the interference for Radio Altimeter and IMT BS position is a combination of: IMT BS gain towards altimeter, radio pathloss and Radio Altimeter gain towards IMT BS:

- The altimeter antenna gain towards MFCN BS will be lower as the gain will be from the sidelobe (- 27 dBi and with 0 degree roll at such lower height). It is maximum gain when the BS is below the Radio Altimeter.
- The free space path loss will get larger as the distance BS to Radio Altimeter will get larger. For 200 feet the minimum distance between BS and Radio Altimeter is about 40 meter whereas OFTS_{noBS,y} is 290 meters for 20 meter BS height.
- The IMT BS antenna gain towards Radio Altimeter can be at its maximum value (~25 dBi for this case) but there are no such strong/sharp fluctuations as observed when the BS is located below the altimeter.

Furthermore below 200 feet there will be additional factors making interference case less likely due to:

- Breakpoints and Radio Altimeter resilience towards possible interference can be expected to be higher and follow similar trend as seen for the values from 1000 and 200 feet (see also discussion in section A6.3.2);
- At lower heights the body loss of the airplane will also have to be considered which will give additional isolation and possible interference from MFCN BSs.

From the above it can be understood that the obstacle limitation surface in combination with the altimeter height of 200 feet is sufficient for the worst-case interference analysis.

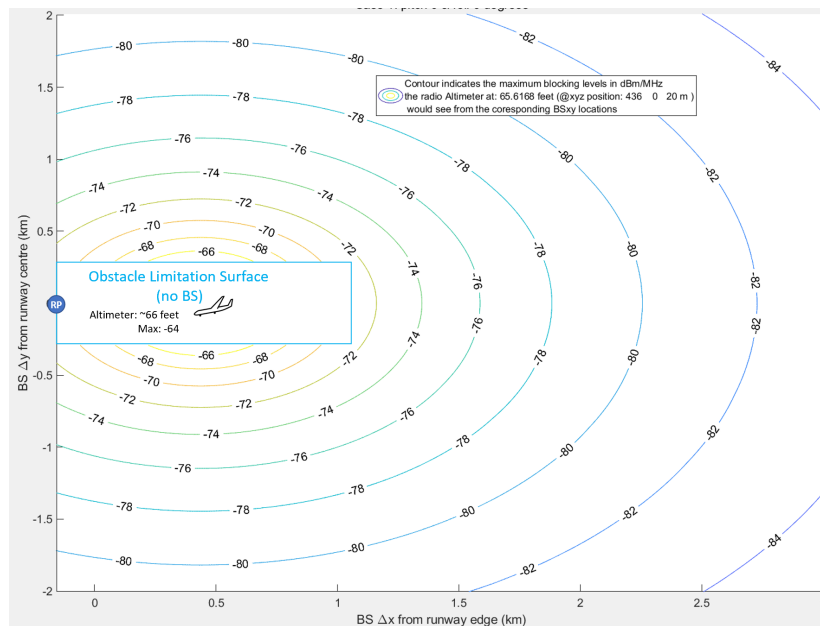

Figure 73: Contour plot showing the maximum OOB blocking levels in dBm/MHz the Altimeter would see from the corresponding Δx , Δy BS location from the RP. The result is for Altimeter at ~66 feet (436, 0, 20) with same height as macro urban BS case

A5.2.6.2 Comparing Radio Altimeter Set 1 and Set 2 values for 200 feet height and maximum OOB blocking level

The maximum OOB blocking level for Set 1 is for 200 feet Radio Altimeter height and BS height 20 meters (see Table 46). The Radio Altimeter model Y as will be shown in the section below gives for this case the lowest margin with 11.4 dB (Table 51 with Model Y at 3.7-3.8 GHz with ITT = -35 dBm/MHz)

The Set 2 ITT value for 200 feet (Table 7 at 3.7-3.8 GHz with ITT = -39 dBm/MHz) is 4 dB worse than the Set 1 with Model Y, meaning altimeter Set 2 model would observe 4 dB higher interference with respect to the ITT values.

Comparing the Altimeter antenna models for the maximum OOB blocking case (3.7-3.8 GHz) with Set 1 as described in The antenna for the in-band case (4.2-4.4 GHz) is modelled using Report ITU-R M.2319 with peak gain and 3 dB beam width based on RTCA Paper No. 274-20/PMC-2073 [25]. For the out-of-band/adjacent channels, the same antenna pattern is used, see Table 9.

Table 8 (parabolic antenna assumption) and using roll up to ± 15 degrees with the “omni-directional” assumption for Set 2 in Table 9 (isotropic antenna assumption including the roll in the antenna gain envelope), a 9 dB higher interference is obtained compared to Set 1 (this includes the cable loss difference as given for Set 1 and Set 2).

A5.3 MARGINS WITH RESPECT TO RADIO ALTIMETER ITT LEVELS

The margins with respect to the altimeter model and frequency ranges for the maximum found OOB blocking and spurious emission (3.4-3.8 GHz), for altimeters at 200 and 1000 feet and BSs outside the obstacle zone are listed in Table 51, Table 52 and Table 53 below. The OOB blocking performance of Altimeter F at 3.7-3.8 GHz is 9 to 10 dB worse than at 3.4-3.7 GHz. Altimeter X (value for 1000 feet) has >10 dB better OOB blocking performance than Altimeter F and Y at 3.7-3.8 GHz. The following can be concluded:

- The results indicate that coexistence is feasible between MFCN and Radio Altimeters with >11 dB positive margins, considering the obstacle limitation surface that are defined for airports.

More specifically:

- The spurious emission shows much larger positive margins compared to the OOB blocking margins and ITT values.
- The margins for 1000 feet are higher than for the 200 feet Radio Altimeter height.
- The highest IMT signal level at the Radio Altimeter is from BSs located within the Approach surface and BS below the OLS, occurs when the BS is within a smaller area below the Radio Altimeter, this is as the free space pathloss is the lowest at that location and larger sharp fluctuation is observed.
- For lower altimeter heights (<200 feet) the BS can not be located below the Radio Altimeter due to the OLS. This safeguards the Radio Altimeter also for altimeter heights below 200 feet from possible IMT BS interference and with BSs below the OLS within the Approach and Transitional surface (Δx , Δy BS positions)
- Pitch and roll for higher altimeter heights and for the case with BS below the Radio Altimeter will increase and shift the sharp peaks observed over a small area.

Replacing altimeter model F and Y in airplanes with other models e.g. model X, L or retrofitted with additional filters would give higher margins.

A5.3.1 OOB Blocking level tables and margins for Radio Altimeter ITTs

Table 51: Margin for Interference Tolerance Threshold (ITT) levels between 3.4-3.8 GHz at 200 feet AGL from Table 2 and maximum predicted OOB blocking level for macro -rural, -suburban and -urban BS height cases in Table 46

Altimeter model	ITT in dBm/MHz for 3.4-3.7 GHz	ITT in dBm/MHz for 3.7-3.8 GHz	Max OOB blocking level simulation in dBm/MHz	Margin in dB	
				3.4-3.7	3.7-3.8 GHz
F	-23	-32	-46.4 (Table 46)	23.4 dB	14.4 dB
L	NB	NB		-	-
T	NB	NB		-	-
X	NB	NB		-	-
U	NB	NB		-	-
Y	NDA	-35		-	11.4 dB

For Altimeter F the U&Tf with 0 dB is applied since the OOB blocking levels consider the worst-case measured altimeter model across temperature and Unit variations.
The simulation values are for 3.6 GHz. Add 0.5 dB for 3.4 GHz and subtract 0.5 dB for 3.8 GHz to the margin to consider difference in free space path loss

Table 52: Margin for Interference Tolerance Threshold (ITT) levels between 3.4-3.8 GHz at 1000 feet AGL from Table 3 and maximum predicted OOB blocking level for macro -rural, -suburban and -urban BS height cases in Table 47

Altimeter model	ITT in dBm/MHz for 3.4-3.7 GHz	ITT in dBm/MHz for 3.7-3.8 GHz	Max OOB blocking level from simulation in dBm/MHz	Margin in dB	
				3.4-3.7 GHz	3.7-3.8 GHz
F	-26	-36	-62.8 (Table 47)	36.8	26.8
L	NB	NB		-	-
T	NB	NB		-	-
X	NB	-26		-	36.8

Altimeter model	ITT in dBm/MHz for 3.4-3.7 GHz	ITT in dBm/MHz for 3.7-3.8 GHz	Max OOB blocking level from simulation in dBm/MHz	Margin in dB	
				3.4-3.7 GHz 3.7-3.8 GHz	
U	NB	NB		-	-
Y	NDA	-41		-	21.8

For Altimeter F the U&Tf with 0 dB is applied since the OOB blocking levels consider the worst-case measured altimeter model across temperature and Unit variations.
The simulation values are for 3.6 GHz. Add 0.5 dB for 3.4 GHz and subtract 0.5 dB for 3.8 GHz to the margin to consider difference in free space path loss

A5.3.2 Spurious emission level table and margins for Radio Altimeter ITTs

Table 53: Margin for Interference Tolerance Threshold (ITT) levels between 4.2 to 4.4 GHz at 200 and 1000 feet AGL from Table 6 and maximum predicted spurious emission for macro rural, suburban and urban BS height cases in Table 48 and Table 49

Altimeter model	ITT in dBm/MHz for 200 feet	ITT in dBm/MHz for 1000 feet	Max interference level simulation in dBm/MHz	Margin in dB	
				200 feet 1000 feet	
F	-73	-85	200 feet: -113.6 (Table 48)	40.6	43.7
L	-81	-81		32.6	47.7
T	-66.8	-71.8		46.8	56.9
X	-63.8	-83.2	1000 feet: -128.7 (Table 49)	49.8	45.5
U	NB	NB		-	-
Y	-70	-84		43.6	44.7

For Altimeter F the U&Tf with 4 dB is applied as there is lack of information about unit to unit variations for interference in the altimeter band.
For Altimeter L and X, the average thresholds provided by the manufacturer are used with U&Tf 4 dB unit to unit variations as a conservative assumption as there is no individual information available on unit-to-unit/ temperature variations. While a standard deviation is provided, there is no basis for considering a 3σ variation which can significantly overestimate the thresholds compared to the measured worst-case altimeter performance. This is evident especially for Altimeter X where the standard deviation is much larger as compared to measurements at other lower heights.

ANNEX 6: STUDY E) SIMULATION RESULTS FOR RADIO ALTIMETER 4200-4400 MHZ COEXISTENCE WITH WBB LMP OPERATED IN 3800-4200 MHZ WITH RADIO ALTIMETER PARAMETER SET 1

A6.1 SUMMARY

This input contains OOB blocking and unwanted emissions results towards Radio Altimeters in 4.2-4.4 GHz, for medium power AAS and non-AAS BSs in 3.8-4.2 GHz band. In general:

- For the base station locations and operational scenarios studied, the Interference Tolerance Threshold (ITT) levels between 3.8-4.2 GHz at 200- and 1000-foot Radio Altimeter heights and worst-case maximum predicted OOB blocking levels show large positive margins with > 42 dB considering the Obstacle Limitation Surface (OLS) that is defined for airports. For non-AAS this margin is about 11 dB lower than for AAS. This considers the worst performing Radio Altimeter model in Set 1 and the closest adjacent IMT channel ($f_c = 4.15$ GHz) to the Radio Altimeter band. Therefore these margins could allow higher base station power than the currently modelled 51 dBm/100 MHz *e.i.r.p.*;
- The margins for ITT levels between 4.2-4.4 GHz at 200 and 1000 feet Radio Altimeter heights and worst-case maximum predicted unwanted emission levels are lower compared to the blocking. The margins are still positive even for the worst performing Radio Altimeter model in Set 1 and considering the closest adjacent IMT channel ($f_c = 4.15$ GHz) to the Radio Altimeter band. The unwanted emissions for the Out-Of-Band from 4200 to 4240 MHz, from the medium power BS, is considered for interference in the Radio Altimeter band from 4.2 to 4.4 GHz;
- For BS heights 30 meters and higher the BS cannot be located below lower altimeter heights (Altimeter: 200 feet is at $\Delta x = 1.163$ km from runway edge reference point). This is as the OLS gives $OFAS_{noBS,x} > 1.56$ km from runway edge reference point for 30 m BS height. This safeguards the Radio Altimeter also for altimeter heights below 200 feet from possible IMT BS interference, with BSs only allowed below the OLS, within the Approach and Transitional surface (for $\Delta x \sim 1.2$ km, $\Delta y > \sim 0.4$ km for BS positions from runway edge reference point). Furthermore, this also applies for BSs with lower heights <30 m if placed below the (OLS around the runway as set by higher BS heights);
- The ITT margins with respect to OOB blocking and unwanted emission can be relative scaled (linearly) in dB with respect to the used power levels in this study. In the accumulated worst-case analysis larger variations in the interference can be found and some of the main factors are: sharp/stronger fluctuation in smaller area when airplane is above the BS, AAS model used and large variation in Radio Altimeter model performances. The altimeter models ITT differs by many dBs and model "F" and "Y" have the lowest performance for the OOB blocking ITT protection and model "L" has the lowest performance for in-band interference ITT. Replacing altimeter model F and Y in airplanes with other models e.g. model X or retrofitted with additional filters would give higher margins.

More details on the findings:

- The OOB blocking has much larger margins compared to the unwanted emission corresponding ITT levels. The margins for 1000 feet, Radio Altimeter height, are higher than for the 200 feet besides for the Radio Altimeter in-band receiver performance for Altimeter model X and Y;
- The highest IMT signal level within the approach surface and for BSs below the OLS occurs when the BS is below the Radio Altimeter, this is as the free space pathloss is the lowest at that location. The possible interference and blocking level increases therefore with lower BS heights as the distance between BS antenna and Radio Altimeter gets shorter. The highest interference levels due to blocking or unwanted emission is from the lower BS height, which is 6 meters in this study;
- The shortest distance for the BS from runway (due to OLS) is for the BS height of 6 meters, which means no BS should be deployed within $\Delta x < 0.36$ km from the runway edge (Approach surface) and $\Delta y < 0.192$ km from the runway centre orthogonal from the runway (Transitional surface);
- The non-AAS maximum blocking levels (3.8-4.2 GHz) at the Radio Altimeter are about 5 to 12 dB higher compared to the AAS, this is mainly as the BS to Radio Altimeter distance is larger for the AAS worst-case situation;
- The highest observed non-AAS interference level due to unwanted emission into the 4.2-4.4 GHz altimeter band is about 4 dB lower than the highest found AAS value. This is due to various factors and one dominating factor is a higher antenna gain towards Radio Altimeter for the AAS worst-case compared to the non-AAS. This is also as the worst-case interference locations for non-AAS and AAS BS are not the same;

- From sensitivity/parametric analysis for different parameters and comparing with the worst-case analysis done for AAS it can be found:
 - For zero roll at 200 feet altimeter height the OOB blocking and unwanted emission level at the Radio Altimeter are ~5 dB lower compared to roll up to ±15 degrees. For the airplane glideslope with 2.625 degrees compared to 3 degrees the difference in OOB blocking and unwanted emission at the Radio Altimeter is 0 dB, but the max value observed is at $\Delta x \sim 1.33$ km from the runway edge compared to $\Delta x \sim 1.16$ km for the 3 degrees slope. Using AAS with 4x4 array of 3x1 sub-array compared to 4x8 array AAS of 3x1 sub-array (for correlated beamforming case with $f_c = 4.15$ GHz) shows 0 dB difference for the OOB blocking as the max e.i.r.p is fixed with 51 dBm/100 MHz e.i.r.p. There is a 3 dB lower unwanted emission level at the altimeter compared to the 4x8 AAS array of 3x1 sub-array.
 - For lower altimeter heights (<200 feet) there are no breakpoints defined. Two cases for lower altimeter heights with (i) the airplane at the same height as the BS height (6 m, 20 feet) and (ii) altimeter above the BS with 6-meter height. For altimeter at the same height as the BS height (airplane $\Delta x = 131$ meters from the RP) the result indicates that the OLS still ensures sufficient protection, and max interference at the altimeter is lower than for the 200 feet altimeter case. For altimeter above the BS (6 m height) with a 54 feet altimeter height, there are also still positive margins for OOB blocking using the 200 feet ITT levels. For the unwanted emissions it depends on the altimeter model if positive margin still exists and on the actual ITT for such low altimeter heights.

The margins in this study consider the ITT values with tolerance as defined in Section 5.3 of this Report. The least resilient Radio Altimeter model from Set 1 is considered. The 6 dB ICAO safety margin is not considered in the ITT values.

A6.2 SIMULATION ASSUMPTIONS

A6.2.1 BS location and obstacle limitation surface

As outlined in section 5.2 and ICAO Annex 14 [26], the obstacle limitation surface around the runway is specified for transitional-, inner horizontal- and the approach-surface (see Figure 7-Figure 9). From this the minimum distance of a BS from the runway (threshold for a specific BS height) can be calculated as given in Table 54 and indicated in Figure 74. The BS heights used in this study for such local area networks are given in [1]. The airplane touchdown point is taken as the Reference Point (RP) in the simulation results. The runway safety area from the runway centre is taken with $a_z = 150$ meters towards the Transitional surface and 60 meters towards the Approach surface. The touchdown point from the runway edge is taken with $b_x = 0$ meter. This will be the tighter case for the BS and possible interference towards Radio Altimeter. For the study the Δx direction towards the Approach surface and the Δy direction towards the Transitional surface will be the main interest when defining the minimum BS separation from the RP.

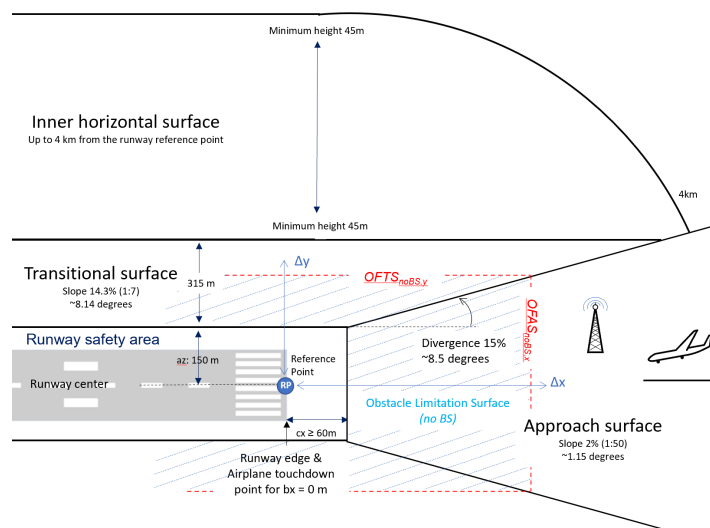

Figure 74: Obstacle limitation surfaces from runway and indicating the BS free zone from the Reference Point (RP) as a function of OLS and BS height

Table 54: Obstacle Free distance as a function of OLS and BS height for (i) Δx along the Approach Surface (named OFAS_{noBS,x}) from runway edge (RP) and (ii) Δy along the Transitional Surface orthogonal to the runway (named OFTS_{noBS,y}) from runway centre (RP)

	OFAS _{noBS,x} from runway edge (BS below OLS along the x-axis)	OFTS _{noBS,y} from runway centre (BS below OLS along the y-axis)
BS height 30 m (Medium power local area non-AAS and AAS)	1.56 km	0.36 km
BS height 6 m (Medium power local area non-AAS and AAS)	0.36 km	0.192 km

A6.2.2 Simulation scenarios and parameters for IMT

The study is done considering the most relevant scenarios and parameters below. The medium in-block power does not follow micro-BS power levels as defined in ETSI/3GPP BS specification and mapping needs to be done for some parameters to fit more realistic AAS BSs performance. In the simulations the focus is on medium power AAS BSs.

Radio Altimeter/Aircraft:

- Airplane glideslope with 3 degrees and for sensitivity/parametric analysis with ± 0.375 degrees variation which can give a closer/smaller distance between altimeter and IMT BS for the same distance from the runway;
- Altimeter heights of 200 and 1000 feet as agreed for the breakpoints.

Altimeter antenna model as given in section 4.3.4.1:

- Assuming roll up to ± 15 degrees for altimeter heights 200 and 1000 feet. For sensitivity/parametric analysis roll/pitch with 0 degree;
- Using Set 1 Altimeter Breakpoint values for 200 and 1000 feet heights. For airplane heights below 200 feet the OOB blocking and unwanted emission at the Radio Altimeter is calculated in the sensitivity/parametric analysis;
- 3 dB cable loss and 3 dB polarisation loss.

IMT BSs AAS and non-AAS for local areas:

- In-block power: 51 dBm/100 MHz *e.i.r.p.* for medium power AAS and non-AAS BSs;
- BS heights: 30 and 6 meters for medium power AAS and non-AAS BSs;
- Minimum BS distance (Δx , Δy) from RP within Approach surface ($> \text{OFAS}_{\text{noBS},x}$) and Transitional surface ($> \text{OFTS}_{\text{noBS},y}$) as given in Table 54.
- Antenna configuration and parameters:
 - For medium power AAS BSs using the sub-array model with antenna array configuration 4 x 8 elements and number of elements rows in sub-array with $M_{\text{sub}} = 3$ with single element gain 6.4 dBi (see Table 12). For the 3.8-4.2 GHz considering AAS it can be expected that sub-arrays will be used similar to the 3.4-3.8 GHz. The antenna configuration will not differ significantly as one needs a minimum number of elements to have sufficient beamforming (like the parameters used in ITU-R WRC-23 Recommendation with 4x8 array of 3X1 subarrays or smaller with 4x4 array of 3x1 sub-array. Therefore, the AAS ITU-R WP5D configuration parameters (macro-urban) for WRC-23 should be reused for the medium power local area BS. Since the sub-array pattern has a narrower beamwidth in the elevation domain as compared to the element pattern, the coverage range in elevation of sub-array configurations will be smaller than that of single element configurations. Thus, it is more appropriate to use the vertical coverage range from 90 to 100 degrees as agreed in the parameters from ITU-R. For the sensitivity/parametric analysis sub-array configuration with 4x4 array of 3x1 sub-array is used. For mechanical downtilt for such configurations and BS heights 6 degrees is used. The pre-set sub-array down-tilt, $\theta_{\text{subtilt}} = 3$ degrees;

- For medium power non-AAS BSs the antenna gain used in this study is 13 dBi using antenna pattern as defined in Recommendation ITU-R F.1336-4 (recommends 3.1) with parameters specified in Report ITU-R M.2292, table 4. A mechanical downtilt with 10 degrees for such local area and BS heights is used in this study;
- In the study the BS sector horizontal boresight is always pointing towards the Radio Altimeter for every BSxy position (worst-case assumption). For AAS the simulation considers from all possible beamforming angles within the vertical coverage range, the worst-case situation towards the Radio Altimeter. For local area BS only one sector per location could be assumed which would make it less likely that the horizontal boresight is pointing towards the Radio Altimeter.

Interference scenarios:

- For the 3.8-4.2 GHz the following two corner cases are simulated;
 - Centre frequency at $f_c = 3.85$ GHz;
 - Centre frequency at $f_c = 4.15$ GHz;
- OOB blocking level at altimeter with fully correlated beamformed AAS antenna gain or non-AAS antenna gain. Altimeter OOB peak antenna gain with 0 and 6 dBi (see Table 9);
- Unwanted emission levels:
 - For AAS with correlated beamforming for $f_c = 4.15$ GHz and the Transitional region Block Edge Mask (BEM) value with 0.94 dBm/5MHz as given in in Table 55. For AAS with uncorrelated beamforming for $f_c = 3.85$ GHz considering sub-array antenna gain and the Baseline BEM value with -3 dBm/5MHz as given in Table 55 (see [32] regarding antenna modelling for uncorrelated beamforming);
 - For non-AAS the OOB unwanted emission limits are given in Table 56. For maximum in-block power with 51 dBm *e.i.r.p.* per sector the P_{max} per antenna connector can be calculated.

For the unwanted emission the altimeter in-band peak antenna gain with 9 dBi () is used.

- For AAS unwanted emission the P_{max} equation in ECC Decision (11)06 [8] cannot be used as P_{max}' is given for AAS in TRP.

The spurious emission domain for the base station in these frequency bands start 40 MHz from the band edge and the corresponding limits are defined in ERC Recommendation 74-01 [4], with -30 dBm/MHz at the antenna connector for non-AAS and -30 dBm/MHz TRP for AAS.

The worst-case interference values as a function of BS antenna heights, AAS beamforming, BS position, Radio Altimeter position, etc. is calculated.

Table 55: Transitional power limits for medium Power AAS BS (ETSI TS 138 104, section 9.7.4, “OTA operating band unwanted emissions”, [35])

BEM element	Frequency range	AAS TRP limit per cell
Transitional region	-5 to 0 MHz offset from lower block edge 0 to 5 MHz offset from upper block edge	+0.94 dBm/5 MHz
Transitional region	-10 to -5 MHz offset from lower block edge 5 to 10 MHz offset from upper block edge	-3 dBm/5 MHz
Baseline	Below -10 MHz offset from lower block edge. Above 10 MHz offset from upper block edge. Within 3800-4200 MHz.	-3 dBm/5 MHz

Note: The BS transitional region BEM elements are based on the assumption that the emissions come from a Micro BS. In a multi-sector base station, the radiated power limit applies to each one of the individual sectors.

Table 56: Baseline and transitional power limits for synchronised MFCN networks for non-AAS base stations, from ECC Decision (11)06 [10]. Same table as in ECC Report for in-band and adjacent bands study where upper power limit is set to 51 dBm/100 MHz e.i.r.p, [1]. The transitional region and baseline limits are also used for out-of-band domain up to the spurious domain

BEM element	Frequency range	Non-AAS e.i.r.p. limit dBm/(5 MHz) per antenna
Transitional region	-5 to 0 MHz offset from lower block edge 0 to 5 MHz offset from upper block edge	Min($P_{max}-40, 21$)
Transitional region	-10 to -5 MHz offset from lower block edge 5 to 10 MHz offset from upper block edge	Min($P_{max}-43, 15$)
Baseline	Below -10 MHz offset from lower block edge. Above 10 MHz offset from upper block edge. Within 3800-4200 MHz.	Min($P_{max}-43, 13$)

A6.2.3 Worst-cases without probabilities

Table 57 lists the worst-cases considered without any probabilities, like known from decision making theory with “maximin” and “maximax” criterion. Different worst-cases for Radio Altimeter and IMT BS can be found, and they can be correlated, uncorrelated or partly correlated in time and space. For example, the height of the airplane with respect to the distance from the runway (touchdown point) is correlated with the glideslope. The obstacle limitation surface which is defined from the runway edge determines the BS location below the OLS. Correlating now the BS height with the glideslope for accumulated worst-case will give very pessimistic results. The accumulated worst-case situations we consider in section A6.3.1 and further assumptions in parameters/settings is considered in section A6.3.2 in order to indicate how much the worst-case outcome in either direction can change. In general, we can note that the problem with such worst-case criterions are:

- a) Lack for the probability of events;
- b) Reliance on extreme values;
- c) Sensitivity to irrelevant factors.

Table 57: Worst-cases considered in the study

Event	Simulation assumptions
Airplane location	Worst-case accumulation for 200- and 1000-feet heights
Airplane landing slope	Normal glideslope with 3 degree and separate sensitivity worst-case analysis for tolerance in glideslope
Airplane pitch/roll	Roll with up to ±15 degree at 200 and 1000 feet for worst-case accumulation and below 200 feet zero roll. Sensitivity analysis for 0 degree roll at 200 feet
Airplane touchdown point	Worst-case with respect to OLS and airplane landing slope by considering airplane landing at the runway edge
Altimeter antenna	Antenna model (M.2319, Equation A-3.6)
Altimeter polarisation loss	Worst-case in sensitivity analysis
Altimeter model	Considering separate altimeter performances as defined for Set 1
BS location	All BS locations below OLS (worst-case accumulation) and discrete BS heights with 6 and 30 meters
BS configuration	Sub-array AAS for 3.8-4.2 GHz as used for 3.4-3.8 GHz band
AAS configuration	4x8 array of 3x1 sub-array AAS for worst-cases accumulation. Sub-array with less

Event	Simulation assumptions
	gain for sensitivity analysis with 4x4 array of 3x1 sub-array
BS sector	Horizontal boresight of sector always pointing towards Radio Altimeter (worst-cases accumulation). For medium power local area BS with one sector per site sensitivity analysis could consider random orientation of sector
BS beamforming	All possible beamforming angles within vertical coverage range (worst-cases accumulation)

A6.3 SIMULATION RESULTS

A6.3.1 Medium power AAS and non-AAS BS in 3.8-4.2 GHz band and Radio Altimeter at 200- and 1000-foot reference points and worst-cases accumulation without probabilities

A6.3.1.1 Contour plots for Radio Altimeter at 200 and 1000 feet (for AAS)

Figure 75 and Figure 77 show the contour plot with the maximum interference levels for OOB blocking at the Radio Altimeter Rx from the corresponding Δx , Δy BS location from the Reference Point (RP) as outlined in Figure 74. The result in Figure 75 is for aircraft at 200 feet (1163, 0, 61) with BS height 6 meters and for BS positions outside the obstacle limitation surface ($\Delta x > 0.36$ km, $\Delta y > 0.192$ km in Table 54). Figure 76 shows the OOB blocking level at the Radio Altimeter for cut along the y-axis at 0 meters in Figure 75. The sharp fluctuation with peaks up to 25 dB in the area $\Delta x = \sim 1.2 \pm 0.3$ km can be seen. The width of the peaks is in the order of ~ 60 meters.

The result in Figure 77 is for aircraft at 1000 feet (5816, 0, 305) with BS height 30 meters and for BS positions below the obstacle limitation surface ($\Delta x > 1.56$ km, $\Delta y > 0.36$ km in Table 54). The IMT centre frequency is in these example figures at 4.15 GHz. It can be seen from the figures:

- The maximum value of the OOB blocking occurs when the BS is just below the Radio Altimeter. This is as the pathloss/distance between BS antenna and Radio Altimeter is the lowest. The fluctuation is in an area of about ± 0.5 km with rather sharp peaks over short distances coming from the sidelobes of the AAS;
- The maximum OOB blocking level at the Radio Altimeter is -75 dBm/MHz for the 200 feet case with BS height 6 m and -89.2 dBm/MHz for the 1000 feet case with BS height 30 m (Table 58, Table 59). As will be shown in section A6.3.3 these maximum OOB blocking levels will give positive margin $> 42/49$ dB (Table 68, Table 69).

Such fluctuation can also be observed for non-AAS but not as pronounced and just about 2 dB from peak to minimum and over a smaller area of about ± 30 meters.

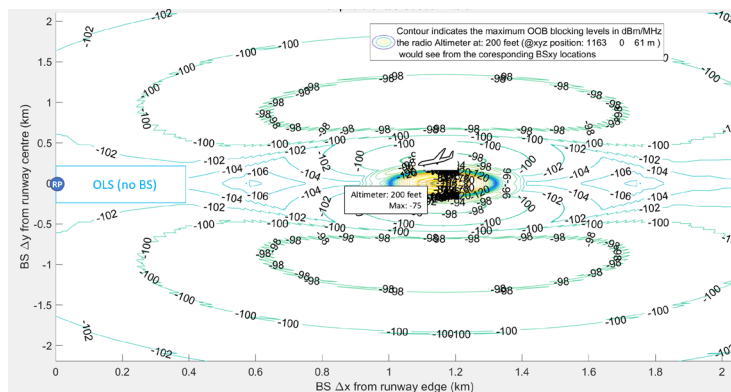

Figure 75: Contour plot showing the maximum OOB blocking levels in dBm/MHz the Altimeter would see from the corresponding Δx , Δy BS location from the RP. The result is for Altimeter at 200 feet (1163, 0, 61) meters, and with up to ± 15 degrees roll. Medium power AAS BS with 6 m height operating at $f_c = 4.15$ GHz

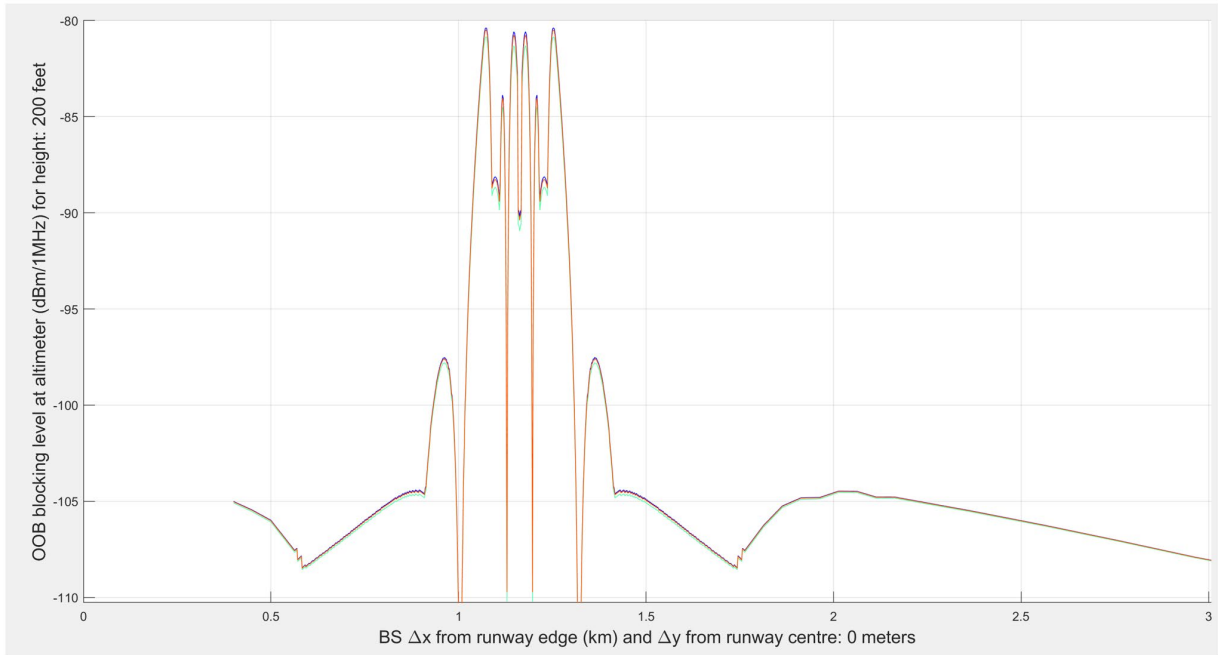

Figure 76: Maximum OOB blocking levels in dBm/MHz the Altimeter would see from the corresponding Δx BS location from the RP (at $\Delta y = 0$ meters). The result is for Altimeter at 200 feet (1163, 0, 61) meters, and with up to ± 15 degrees roll. Medium power AAS BS with 6 m height operating at $f_c = 4.15$ GHz

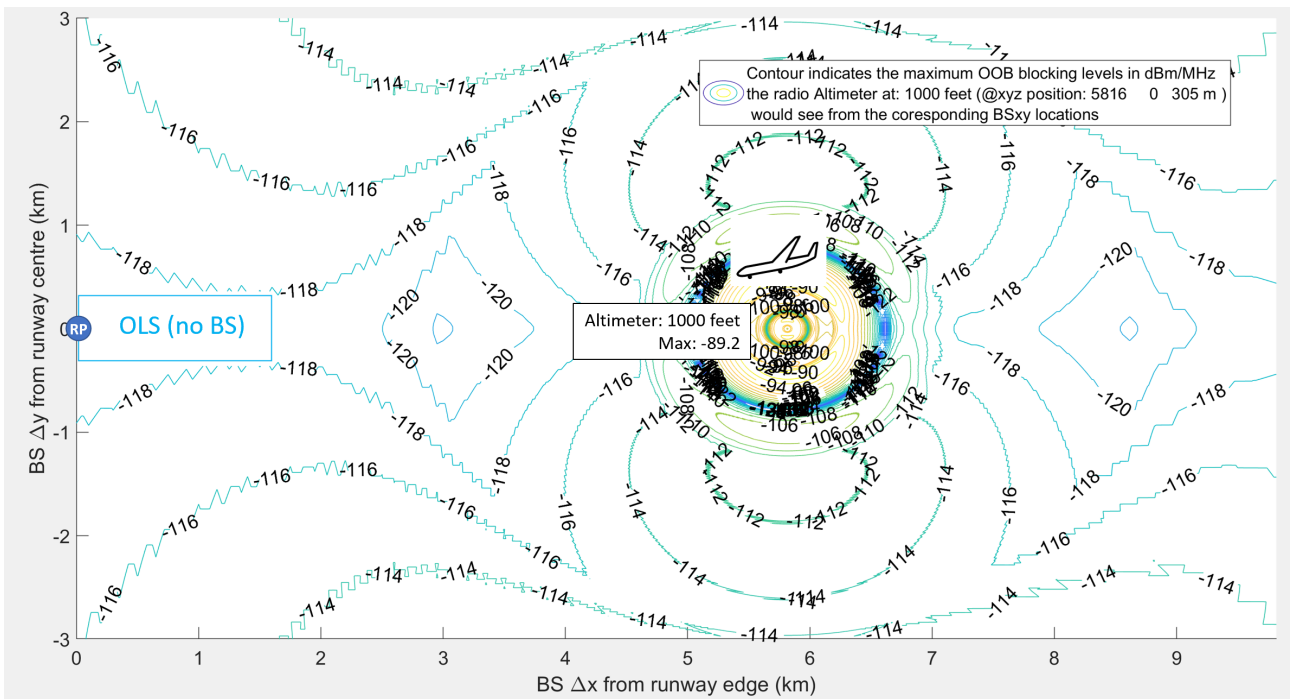

Figure 77: Contour plot showing the maximum spurious emission levels in dBm/MHz the Altimeter would see from the corresponding $\Delta x, \Delta y$ BS location from the RP. The result is for Altimeter at 1000 feet (5816, 0, 305) meters, and with up to ± 15 degrees roll. Medium power AAS BS with 30 m height operating at $f_c = 4.15$ GHz

A6.3.1.2 Tables with maximum OOB blocking level results

Table 58 and Table 59 give the maximum OOB blocking levels for Altimeters at 200 and 1000 feet with up to ± 15 -degree roll for AAS BS, heights 6 and 30 meters, and for BSs below the obstacle limitation surface for centre frequencies at $f_c = 3.85$ GHz and 4.15 GHz. The Radio Altimeter breakpoints and the OOB blocking levels differ for these two frequencies. From the tables we can conclude:

- The highest observed OOB blocking level with -75 dBm/MHz occurs for the altimeter height 200 feet, BS height 6 meter and $f_c = 4.15$ GHz. This is mainly as the BS free zone (for below OLS) is $\Delta x = 1.56$ km for 30 m BS height compared to 0.36 km at 6 m BS height (see Table 54) and distance/pathloss between IMT BS and Radio Altimeter for the BS location causing the max OOB blocking level towards the Radio Altimeter is ~ 507 m/99 dB for the 30 m BS height and ~ 106 m/85 dB for the 6 m BS height;
- The highest observed OOB blocking level occurs when the Radio Altimeter is above the BS location which in the case of BS height 6 m is within Δx : 1.05 to 1.25 km and Radio Altimeter at ~ 1.3 km for 200 feet. This is as the pathloss is the lowest at that point. For 30 m BS height the BS free zone (for below OLS) Δx is > 1.56 km (OFAS_{noBS,x} in Table 54);
- The difference between $f_c = 3.85$ GHz and $f_c = 4.15$ GHz for the same BS heights is mainly due to the altimeter difference in antenna gain for the OOB which is 6 dB;
- The OOB blocking values comparing altimeter at 200 feet (Table 58) with 1000 feet (Table 59) for the same f_c is about 15 dB lower for the 6 meter BS height and the 200 feet case compared to the 1000 feet case and this is mainly due to lower pathloss. For the 30 meter BS height the 1000 feet values are slightly lower than for the 200 feet case and this is due to the BS free zone (for below OLS) and the resulting distance between Radio Altimeter and BS;
- The highest OOB blocking value for 1000 feet Radio Altimeter height is -89.2 dBm/MHz (Table 59) for BS height 30 meter and $f_c = 4.15$ GHz. We also observe that the difference between the BS height 6 and 30 meters for same f_c is small (< 1 dB) and this is as the pathloss/distance between IMT BS in xy-grid causing the highest OOB blocking value towards the Altimeter is about the same for these BS heights (see Δx in the table).

For different altimeter heights and considering zero roll/pitch the influence on the blocking results is discussed in section A6.3.2.

Table 58: Maximum OOB blocking levels at Radio Altimeter 200 feet height with roll up to ± 15 degrees, for medium power AAS BS below the obstacle limitation surface

	BS height 6 m $f_c = 3.85$ GHz	BS height 30 m $f_c = 3.85$ GHz	BS height 6 m $f_c = 4.15$ GHz	BS height 30 m $f_c = 4.15$ GHz
Maximum OOB blocking level at altimeter	-80.6 dBm/MHz	-96.9 dBm/MHz	-75.2 dBm/MHz	-91.6 dBm/MHz
Max value from BS at position (for max to (max-3 dB) range)	Δx : 1.05 to 1.25 km Δy : at ± 0.1 km	Δx : 0.5 to 1.7 km Δy : at ± 0.36 to ± 0.7 km	Δx : 1.05 to 1.25 km Δy : at ± 0.1 km	Δx : 0.5 to 1.7 km Δy : at ± 0.36 to 1 km

Table 59: Maximum OOB blocking levels at Radio Altimeter 1000 feet height with roll up to ±15 degrees, for medium power AAS BS below the obstacle limitation surface

	BS height 6 m fc = 3.85 GHz	BS height 30 m fc = 3.85 GHz	BS height 6 m fc = 4.15 GHz	BS height 30 m fc = 4.15 GHz
Maximum OOB blocking level at altimeter	-95.3 dBm/MHz	-94.5 dBm/MHz	-89.9 dBm/MHz	-89.2 dBm/MHz
Max value from BS at position (for max to (max-3 dB) range)	Δx: 5.3 to 6.3 km Δy: ±0.6 km	Δx: 5.3 to 6.3 km Δy: ±0.6 km	Δx: 5.4 to 6.2 km Δy: ±0.6 km	Δx: 5.4 to 6.2 km Δy: ±0.6 km

For non-AAS medium power local area BS the maximum OOB blocking levels for BS with 6- and 30-meters heights and for fc = 3.85 and fc = 4.15 GHz is given below. We observe:

- The non-AAS follows similar trend as the AAS with the maximum blocking levels observed for the 200 feet Radio Altimeter case and BS height 6 meters at fc = 4.15 GHz
- The non-AAS maximum blocking levels are about 5 to 12 dB higher compared to the AAS and this is mainly as the BS to Radio Altimeter distance causing the maximum values is larger for the AAS. For the 1000 feet the altimeter gain towards the IMT BS adds also to the difference observed

Table 60: Maximum OOB blocking levels at Radio Altimeter 200 feet height with roll up to ±15 degrees, for medium power non-AAS BS below the obstacle limitation surface.

	BS height 6 m fc = 3.85 GHz	BS height 30 m fc = 3.85 GHz	BS height 6 m fc = 4.15 GHz	BS height 30 m fc = 4.15 GHz
Maximum OOB blocking level at altimeter	-69.6 dBm/MHz	-91.3 dBm/MHz	-64.3 dBm/MHz	-85.9 dBm/MHz
Max value from BS at position (for max to (max-3 dB) range)	Δx: 1.13 to 1.2 km Δy: at ±0.1 km	Δx: 0.8 to 1.5 km Δy: at ±0.36 to ±0.6 km	Δx: 1.13 to 1.2 km Δy: at ±0.1 km	Δx: 0.8 to 1.5 km Δy: at ±0.36 to ±0.6 km

Table 61: Maximum OOB blocking levels at Radio Altimeter 1000 feet height with roll up to ±15 degrees, for medium power non-AAS BS below the obstacle limitation surface

	BS height 6 m fc = 3.85 GHz	BS height 30 m fc = 3.85 GHz	BS height 6 m fc = 4.15 GHz	BS height 30 m fc = 4.15 GHz
Maximum OOB blocking level at altimeter	-84.4 dBm/MHz	-83.6 dBm/MHz	-79 dBm/MHz	-78.3 dBm/MHz
Max value from BS at position (for max to (max-3 dB) range)	Δx: 5.6 to 6 km Δy: ±0.3 km	Δx: 5.6 to 6 km Δy: ±0.3 km	Δx: 5.6 to 6 km Δy: ±0.3 km	Δx: 5.6 to 6 km Δy: ±0.3 km

A6.3.1.3 Tables with maximum unwanted emission level results

Table 62 and Table 63 give the maximum interference due to unwanted emissions for Altimeters at 200 and 1000 feet for 6- and 30-meters medium power AAS BS heights and for BSs below the obstacle limitation surface with up to ±15-degrees roll. For 3.85 GHz uncorrelated beamforming is assumed and for 4.15 GHz correlated beamforming is assumed. The maximum altimeter antenna gain is 9 dBi as given in The antenna for the in-band case (4.2-4.4 GHz) is modelled using Report ITU-R M.2319 with peak gain and 3 dB beam width based on RTCA Paper No. 274-20/PMC-2073 [25]. For the out-of-band/adjacent channels, the same antenna pattern is used, see Table 9.

Table 8. From Table 63 and Table 64, it can be observed:

- The highest observed unwanted emission level is -81.8 dBm/MHz from BS height 6 m, Radio Altimeter at 200 feet and $f_c = 4.15$ GHz. It is for the location when the BS_{xy} location is just about below the Radio Altimeter at 200 feet;
- The difference between $f_c = 3.85$ GHz and 4.15 GHz is mainly due to the fact that fully correlated beamforming is assumed and the transitional region unwanted emission value with +0.94 dBm/5 MHz (Table 55) for this upper corner case;
- The highest unwanted emission value for 1000 feet Radio Altimeter height is -95 dBm/MHz (Table 63) for BS height 30 meter and $f_c = 4.15$ GHz. We also observe that the difference between the BS height 6 and 30 meters for same f_c is small (<1dB) and this is as the pathloss/distance between IMT BS in xy-grid causing the highest OOB blocking value towards the Altimeter is about the same for these BS heights (see Δx in the table);
- In general, the findings comparing 200/1000 feet, 6/30 m BS height and $f_c=3.85/4.15$ GHz in the tables follows the same findings as outlined above for the OOB blocking values.

For non-AAS medium power in Table 64 and Table 65, it can be observed:

- The highest observed value is for 6 m BS height and $f_c = 4.15$ GHz as for the AAS case;
- The highest observed non-AAS value is about 4 dB lower (Table 64) than the highest AAS value (Table 62), This is due to various factors and one dominating factor is a higher antenna gain towards Radio Altimeter for the AAS worst-case compared to the non-AAS. This is also as the worst-case locations for non-AAS and AAS BS are not the same.

Table 62: Maximum unwanted emission levels at Radio Altimeter 200 feet height with roll up to ±15 degrees, for medium power AAS BS below the obstacle limitation surface

	BS height 6 m $f_c = 3.85$ GHz	BS height 30 m $f_c = 3.85$ GHz	BS height 6 m $f_c = 4.15$ GHz	BS height 30 m $f_c = 4.15$ GHz
Maximum unwanted emission level at altimeter	-96.7 dBm/MHz	-109.4 dBm/MHz	-84.1 dBm/MHz	-100.4 dBm/MHz
Max value from BS at position (for max to (max-3 dB) range)	Δx : 1 to 1.3 km Δy : at ±0.1 km	Δx : 0.8 to 1.5 km Δy : at ±0.36 to ±0.6 km	Δx : 1 to 1.25 km Δy : at ±0.1 km	Δx : 0.6 to 1.7 km Δy : at ±0.36 to ±1 km

Table 63: Maximum unwanted emissions levels at Radio Altimeter 1000 feet height with roll up to ±15 degrees, for medium power AAS BS below the obstacle limitation surface

	BS height 6 m $f_c = 3.85$ GHz	BS height 30 m $f_c = 3.85$ GHz	BS height 6 m $f_c = 4.15$ GHz	BS height 30 m $f_c = 4.15$ GHz
Maximum unwanted emission level at altimeter:	-111.4 dBm/MHz	-110.7 dBm/MHz	-98.8 dBm/MHz	-98 dBm/MHz

	BS height 6 m fc = 3.85 GHz	BS height 30 m fc = 3.85 GHz	BS height 6 m fc = 4.15 GHz	BS height 30 m fc = 4.15 GHz
Max value from BS at position (for max to (max-3 dB) range):	Δx : 5.3 to 6.3 km Δy : ± 0.6 km	Δx : 5.3 to 6.3 km Δy : ± 0.6 km	Δx : 5.3 to 6.3 km Δy : ± 0.6 km	Δx : 5.3 to 6.3 km Δy : ± 0.6 km

Table 64: Maximum unwanted emission levels at Radio Altimeter 200 feet height with roll up to ± 15 degrees, for medium power non-AAS BS below the obstacle limitation surface.

	BS height 6 m fc = 3.85 GHz	BS height 30 m fc = 3.85 GHz	BS height 6 m fc = 4.15 GHz	BS height 30 m fc = 4.15 GHz
Maximum unwanted emission level at altimeter:	-90.7 dBm/MHz	-112.3 dBm/MHz	-88.3 dBm/MHz	-109.9 dBm/MHz
Max value from BS at position (for max to (max-3 dB) range):	Δx : 1.13 to 1.2 km Δy : at ± 0.1 km	Δx : 0.9 to 1.4 km Δy : at ± 0.36 to ± 0.5 km	Δx : 1.12 to 1.2 km Δy : at ± 0.1 km	Δx : 0.8 to 1.5 km Δy : at ± 0.36 to ± 0.7 km

Table 65: Maximum unwanted emissions levels at Radio Altimeter 1000 feet height with roll up to ± 15 degrees, for medium power non-AAS BS below the obstacle limitation surface

	BS height 6 m fc = 3.85 GHz	BS height 30 m fc = 3.85 GHz	BS height 6 m fc = 4.15 GHz	BS height 30 m fc = 4.15 GHz
Maximum unwanted emission level at altimeter:	-105.4 dBm/MHz	-104.6 dBm/MHz	-103 dBm/MHz	-102.3 dBm/MHz
Max value from BS at position (for max to (max-3 dB) range):	Δx : 5.6 to 6 km Δy : ± 0.3 km	Δx : 5.6 to 6 km Δy : ± 0.3 km	Δx : 5.6 to 6 km Δy : ± 0.3 km	Δx : 5.6 to 6 km Δy : ± 0.3 km

A6.3.2 Additional parameter analysis for AAS to the worst-cases accumulation

A sensitivity/parametric analysis is done for additional/different parameters/settings used in section A6.3.1 to understand how such can change the outcome in either direction:

- Roll with 0 degree at the 200 feet altimeter heights for which Breakpoints are defined;
- Airplane glideslope with 2.625 degrees including possible variation in landing slope (± 0.375 degrees);
- Altimeter without polarisation loss;
- Sub-array AAS model with 4x4 array of 3x1 sub-array;
- Interference analysis for altimeter heights <200 feet;
- Comparing Radio Altimeter Set 1 and Set 2 ITT values.

Table 66 gives in dB the difference in interference levels for the worst-cases found in Table 58 and Table 62 for Radio Altimeter height 200 feet and for the different parameters listed above. We can also note that the ITT margins with respect to OOB blocking and unwanted emission can be relative scaled linearly in dB with respect to the used power levels in this study. The sensitivity/parametric analysis is useful as worst-case study without probabilities is being conducted.

Table 66: Difference in interference to parameter used in section A6.3.1 for 200 feet Radio Altimeter height

Parameter	Difference in dB
Roll with 0 degree compared to roll up to ±15 degrees	-5 dB (for the peak value) Roll will shift the maximum observed peaks within the high fluctuation area which will mainly matter to Δy and the Transitional surface. Outside the high fluctuation area, the difference roll makes is less. Note: The peak will depend if BS can be in smaller area below Radio Altimeter which depends on OLS
Airplane glideslope with 2.625 degrees compared to 3 degrees	0 dB (for the peak value) But max value observed at ~1.33km Δx from RP compared to ~1.16 km for 3 degrees slope Note: The peak will depend if BS can be in smaller area below Radio Altimeter which depends on OLS
Airplane touchdown point (RP)	Any difference in the Reference Point (RP) will shift the results in x or y direction by the difference in meters
Polarisation loss	+3 dB if altimeter uses linearly polarised receivers
Sub-array AAS with 4x4 array of 3x1 sub-array AAS compared to 4x8 array of 3x1 sub-array (for correlated beamforming case with $f_c = 4.15$ GHz)	0 dB for the OOB blocking -3 dB for the unwanted emission

A6.3.2.1 Altimeter heights < 200 feet

In general, for decreasing altimeter heights, we could expect that the Breakpoint threshold values increase because the received radar signal increase due to shorter distances to the ground and therefore lower pathloss. For free space the two-way pathloss difference for 200 and 1000 feet at 4.1 GHz is ~14 dB (see Figure 78). Looking at the various Altimeter ITT values for 200 and 1000 feet, some Altimeter models seem to follow this rule e.g. Altimeter model F for 4.2-4.4 GHz sensitivity ~12 dB difference between 200/1000 feet, but altimeter model L does not seem to follow this rule as the breakpoint value is the same for 200 and 1000 feet height. This will make it difficult to quantify the results for altimeter heights different to 200 and 1000 feet.

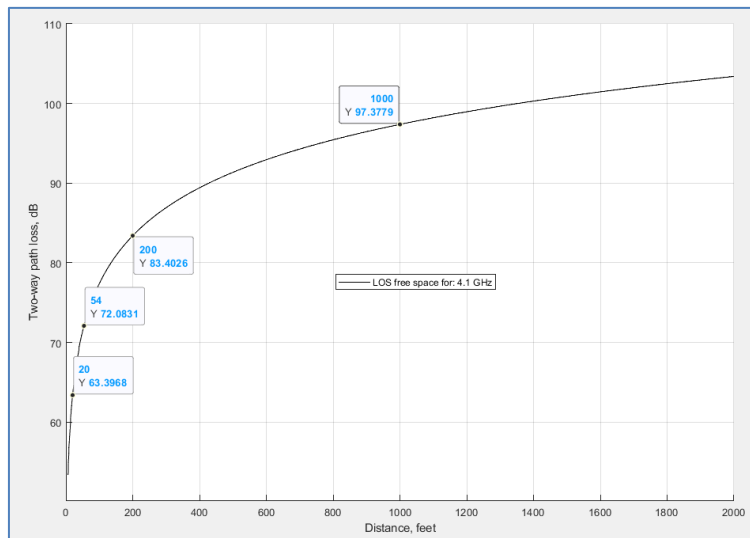

Figure 78: Two-way free space pathloss at 4.1 GHz for different distances in feet

For medium power AAS BS with 6-meter height, the following two cases can be simulated:

- Case (a) with Altimeter at ~20 feet: For the aircraft at the same height as the BS which is for Radio Altimeter at ~20 feet (xyz-coordinate: 131, 0, 6 meters);
- Case (b) with Altimeter at ~54 feet: For the aircraft at $\Delta x = 0.36$ km which is the shortest distance a BS with such height can be placed from the runway (see Table 54), which is for Radio Altimeter at ~54 feet (xyz-coordinate: 360, 0, 16.5 meters).

The parameters from the sensitivity analysis in Table 66 are used with AAS with 4x4 array of 3x1 sub-array and airplane glideslope with 2.625 degrees. Pitch and roll we excluded for such low heights as the airplane wing would risk touching an object even within the obstacle limitation surface. The contour plot for these two cases is in Figure 79 and Figure 80:

- For Case (a) with Altimeter at ~20 feet: The maximum OOB blocking is -91 dBm/MHz and maximum unwanted emission level is -100 dBm/MHz at the Radio Altimeter. The maximum value is found at BSxy in the transitional surface ($\Delta y > 192$ m, see also Table 54 min distance OLS for 6 m BS height). Both values are lower than the maximum values for 200 feet in Table 58 and Table 62. This can also be understood as the distance/pathloss between IMT BS and Radio Altimeter (193 m/91 dB) is larger compared with the 200 feet and 6 m BS height case (68 m/81 dB) and the altimeter gain (sidelobe) is lower. The IMT BS antenna beamforming gain towards Radio Altimeter can be at its maximum value but there are no such strong/sharp fluctuations as observed when the BS is located below the altimeter;
- Case (b) with Altimeter at ~54 feet: The maximum OOB blocking is -67 dBm/MHz and maximum unwanted emission level is -75 dBm/MHz at the Radio Altimeter. Both values are higher than the maximum values for 200 feet in Table 58 and Table 62. This can also be understood as the distance/pathloss between IMT BS and Radio Altimeter is shorter/smaller (13 m/67 dB) compared to the 200 feet and 6 m BS height case (68 m/81 dB). The OOB blocking level if comparing with the Breakpoints at 200 feet in Table 62 would still have sufficient margins. The unwanted emission level comparing with the Breakpoints in Table 75 would also still have enough margin beside Altimeter Model L. It is observed, as mentioned above, that Altimeter Model "L" has the same performance at 200 and 1000 feet.

Furthermore, the Breakpoints and Radio Altimeter resilience towards possible interference can be expected to be higher and follow similar trend as seen for the values from 1000 and 200 feet for most of the altimeter models. At lower heights the body loss of the airplane will also have to be considered which will give additional isolation from MFCN BSs.

The results, including lower altimeter heights (<200 feet), indicate that the BS power with 51 dBm/100 MHz could be increased by more than 20 dB as margins are >30 dB even for BS height 6 meters and $\Delta x = 0.36$ km from the runway edge. For the unwanted emission ITT, depending on Altimeter model, for BS with 6 m height at $\Delta x = 0.36$ km and altimeter heights below <200 feet, the altimeter model L may need improvement.

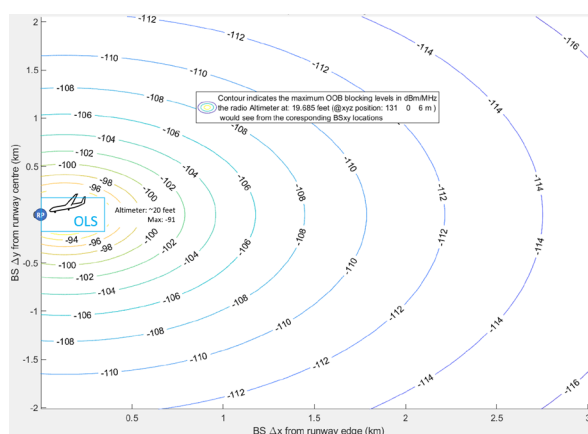

Figure 79: Contour plot showing the maximum spurious emission levels in dBm/MHz the Altimeter would see from the corresponding Δx , Δy BS location from the RP. The result is for Altimeter at ~20 feet (131, 0, 6) and medium power AAS BS with 6 m height operating at $f_c = 4.15$ GHz and with roll/pitch 0 degree

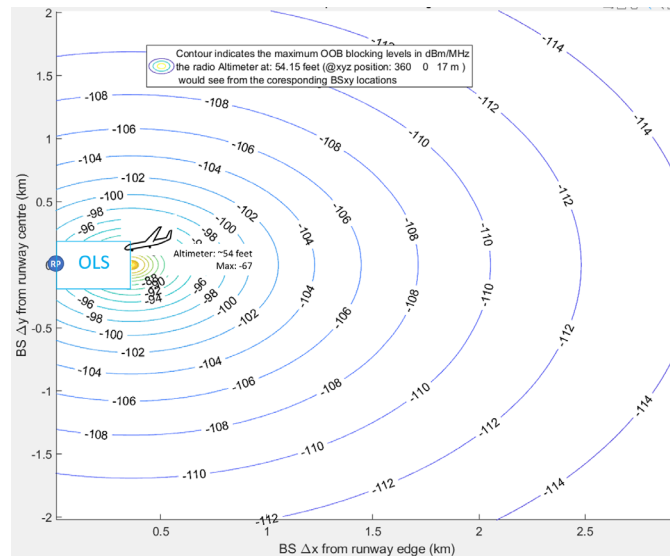

Figure 80: Contour plot showing the maximum spurious emission levels in dBm/MHz the Altimeter would see from the corresponding Δx , Δy BS location from the RP. The result is for Altimeter at ~54 feet (360, 0, 17) and medium power AAS BS with 6 m height operating at $f_c = 4.15$ GHz and with roll/pitch 0 degree

A6.3.2.2 Comparing Radio Altimeter Set 1 and Set2 values for 200 feet height and maximum interference level

The maximum interference level (4.2-4.4 GHz) for Set 1 is for 200 feet Radio Altimeter height and BS height 6 meters (see Table 62). The Radio Altimeter model L as will be shown in the section below gives for this case the lowest margin with 3.1 dB (Table 76 with Model L at 4.2-4.4 GHz and ITT = -81 dBm/MHz)

- The Set 2 ITT value for 200 feet (Table 7 for 4.2-4.4 GHz and ITT = -80 dBm/MHz) is 1 dB better performance than the Set 1 with Model L, meaning altimeter Set 2 model would observe 1 dB less interference with respect to the ITT values

For the in-band interference (4.2-4.4 GHz) both Set1 in The antenna for the in-band case (4.2-4.4 GHz) is modelled using Report ITU-R M.2319 with peak gain and 3 dB beam width based on RTCA Paper No. 274-20/PMC-2073 [25]. For the out-of-band/adjacent channels, the same antenna pattern is used, see Table 9.

Table and Set 2 in Table 9 use the same antenna model and the peak gain assumption differs by only 1 dB.

A6.3.3 Observed worst-case situations in space and time

From the interference results above and from the margin analysis with respect to Radio Altimeter performances (ITT levels) as done in the section below, single event/values for worst-case situations without probability can be identified which can cause more than 20 dB difference in the results:

- Where the BS is below the airplane and outside the OLS. For Altimeter at 200 feet, and for lower BS heights, we see sharp fluctuation with peaks up to 25 dB in a region at $\Delta x = \sim 1.2 \pm 0.3$ km (see Figure 75 and Figure 76). This area is limited, and it can also be noted:
 - The width of the peaks is in the order of ~60 meters. The airplane will pass such a peak within about one second in time for typical landing speeds of ~56 m/s (200 km/h);
 - For other locations, especially lateral offsets (along y-axis) possible interference is less a problem and this is as the altimeter gain towards IMT BS gets less and as the free space path loss gives higher attenuations due to larger distance between BS and Radio Altimeter;
 - The Altimeter models ITT values differ by many dB.

A6.3.3.1 Margins with respect to Radio Altimeter itt levels

The margins with respect to the altimeter model and frequency ranges for the maximum found OOB blocking and unwanted emission (3.8-4.2 GHz) for altimeters at 200 and 1000 feet and BSs outside the OLS are listed in the tables below:

- AAS has about 11 dB higher blocking margin than non-AAS for the lowest blocking margin found:
- For AAS the OOB blocking margin is > 42 dB (Table 68). Which is the case for the worst performing Radio Altimeter model "F", for 200 feet Radio Altimeter height, $f_c = 4.15$ GHz and 6 m BS height. For higher BS height with 30 m (> BS free zone due to OLS) the margin increases with ~16 dB (Table 62).
- For non-AAS the OOB blocking margin is > 31 dB (Table 72). Which is the case for the worst performing Radio Altimeter model "F", for 200 feet Radio Altimeter height, $f_c = 4.15$ GHz and 6 m BS height. For higher BS height with 30 m (> BS free zone due to OLS) the margin increases with ~21.5 dB (Table 71).
- Depending on the BS height and Radio Altimeter height and if BS can be located below the Radio Altimeter height and below the OLS it is observed:
 - For AAS with 6 m BS height and Radio Altimeter at 200 and 1000 feet (Table 68 and Table 70) the margins are larger for 1000 feet. For 30 m BS height and Radio Altimeter at 200 and 1000 feet (Table 62 and Table 69) the margins are larger for 200 feet;
 - For non-AAS with 6 m BS height and Radio Altimeter at 200 and 1000 feet (Table 72 and Table 74) the margins are larger for 1000 feet. For 30 m BS height and Radio Altimeter at 200 and 1000 feet (Table 71 and Table 73) the margins are larger for 200 feet.
 - The unwanted emission margins are smaller compared with the blocking margin but still positive for non-AAS and AAS (Table 75 to Table 78):
 - The unwanted emission margins for the altimeter at 200 and 1000 feet are >11dB besides for altimeter model "L" at 200 feet. This is for IMT with $f_c = 4.15$ GHz the closest channel adjacent to the Radio Altimeter band starting at 4.2 GHz and OOB unwanted emission domain as observed in the first 5 MHz. Having BS free zone due to OLS as defined by 30 m BS height also for lower BS heights (e.g. 6 m) would increase the margin for e.g. model "L" considerably. Compare Table 75 and Table 76 for AAS and Table 77 and Table 78 for non-AAS;
 - If using the average unwanted emissions from 4200 MHz to 4360 MHz, including spurious emissions, as done in Study B and K would add >8 dB positive margin in Table 75 to Table 78;
 - For 200 feet Radio Altimeter height the margins and comparing 6 with 30 m BS height results. The margins are higher for 30 m BS height compared with 6 m BS height for AAS (Table 75 and Table 76) and for non-AAS (Table 77 and Table 78);
 - For 1000 feet Radio Altimeter height the margins differ little between the 6 m and 30 m BS height for both AAS and non-AAS;
 - For 30 m BS height the margins are higher for Radio Altimeter height 200 feet compared with 1000 feet (Table 75 AAS and Table 77 non-AAS). For 6 m BS height the margins are higher for 1000 feet Radio Altimeter height compared with 200 feet beside for Altimeter model "X" (Table 76) and Table 78).

The Altimeter models ITT differs by many dBs and model "F" and "Y" have the lowest performance for the OOB blocking ITT protection and model "L" has the lowest performance for in-band interference ITT. Replacing altimeter model F and Y in airplanes with other models e.g. model X or retrofitted with additional filters would give higher margins.

A6.3.3.2 Tables for OOB blocking AAS BS and margins for Radio Altimeter ITTs

Table 67: Margin for Interference Tolerance Threshold (ITT) levels between 3.8 and 4.2 GHz at 200 feet AGL in Table 4 and maximum predicted blocking level for local area medium power AAS BS with 30 m BS height in Table 58

Altimeter model	ITT in dBm/MHz for 3.8-4.1 GHz	ITT in dBm/MHz for 4.1-4.2 GHz	Max blocking level simulation in dBm/MHz for 3.85 GHz 4.15 GHz	Margin in dB 3.8-4.1 4.1-4.2 GHz	
F	-37	-33	-96.9 -91.6 (Table 58 and for 30 m BS height)	59.9	58.6
L	-10	NDA		86.9	-
T	NB	NB		-	-
X	-30	NDA		66.9	-
U	NB	NB		-	-
Y	-34	NDA		62.9	-

For Altimeter F the U&T_f with 0 dB is applied since the blocking levels consider the worst-case measured altimeter model across temperature and Unit variations.

Table 68: Margin for Interference Tolerance Threshold (ITT) levels between 3.8-4.2 GHz at 200 feet AGL in Table 4 and maximum predicted blocking level for local area medium power AAS BS with 6 m BS height in Table 58

Altimeter model	ITT in dBm/MHz for 3.8-4.1 GHz	ITT in dBm/MHz for 4.1-4.2 GHz	Max blocking level simulation in dBm/MHz for 3.85 GHz 4.15 GHz	Margin in dB 3.8-4.1 4.1-4.2 GHz	
F	-37	-33	-80.6 -75.2 (Table 58 and for 6 m BS height)	43.4	42.2
L	-10	NDA		70.6	-
T	NB	NB		-	-
X	-30	NDA		50.6	-
U	NB	NB		-	-
Y	-34	NDA		46.6	-

For Altimeter F the U&T_f with 0 dB is applied since the blocking levels consider the worst-case measured altimeter model across temperature and Unit variations.

Table 69: Margin for Interference Tolerance Threshold (ITT) levels between 3.8-4.2 GHz at 1000 feet AGL in Table 5 and maximum predicted blocking level for local area medium power AAS BS with 30 m BS height in Table 59

Altimeter model	ITT in dBm/MHz for 3.8-4.1GHz	ITT in dBm/MHz for 4.1-4.2 GHz	Max blocking level simulation in dBm/MHz for 3.85 GHz 4.15 GHz	Margin in dB 3.8-4.1 4.1-4.2 GHz	
F	-42	-39	-94.5 -89.2 (Table 59 and for 30 m BS height)	52.5	50.2
L	-9	NDA		85.5	-
T	-36.9	-39.8		57.6	49.4
X	-38	NDA		56.5	-
U	NB	NB		-	-
Y	-43	NDA		51.5	-

For Altimeter F the U&T_f with 0 dB is applied since the blocking levels consider the worst-case measured altimeter model across

Altimeter model	ITT in dBm/MHz for 3.8-4.1GHz	ITT in dBm/MHz for 4.1-4.2 GHz	Max blocking level simulation in dBm/MHz 3.85 GHz 4.15 GHz	Margin in dB 3.8-4.1 4.1-4.2 GHz
temperature and Unit variations.				

Table 70: Margin for Interference Tolerance Threshold (ITT) levels between 3.8-4.2 GHz at 1000 feet AGL in Table 5 and maximum predicted blocking level for local area medium power AAS BS with 6 m BS height in Table 59

Altimeter model	ITT in dBm/MHz for 3.8-4.1 GHz	ITT in dBm/MHz for 4.1-4.2 GHz	Max blocking level simulation in dBm/MHz 3.85 GHz 4.15 GHz	Margin in dB 3.8-4.1 GHz 4.1-4.2 GHz	
F	-42	-39	-95.3 -89.9 (Table 59 and for 6 m BS height)	53.3	50.9
L	-9	NDA		86.3	-
T	-36.9	-39.8		58.4	50.1
X	-38	NDA		57.3	-
U	NB	NB		-	-
Y	-43	NDA		52.3	-
For Altimeter F the U&T _f with 0 dB is applied since the blocking levels consider the worst-case measured altimeter model across temperature and Unit variations.					

A6.3.3.3 Tables for OOB blocking from non-AAS BS and margins for Radio Altimeter ITTs

Table 71: Margin for Interference Tolerance Threshold (ITT) levels between 3.8-4.2 GHz at 200 feet AGL in Table 4 and maximum predicted blocking level for local area medium power non-AAS BS with 30 m BS height in Table 60

Altimeter model	ITT in dBm/MHz for 3.8-4.1 GHz	ITT in dBm/MHz for 4.1-4.2 GHz	Max blocking level simulation in dBm/MHz for 3.85 GHz 4.15 GHz	Margin in dB 3.8-4.1 GHz 4.1-4.2 GHz	
F	-37	-33	-91.3 -85.9 (Table 60 and for 30 m BS height)	54.3	52.8
L	-10	NDA		81.3	-
T	NB	NB		-	-
X	-30	NDA		61.3	-
U	NB	NB		-	-
Y	-34	NDA		57.3	-
For Altimeter F the U&T _f with 0 dB is applied since the blocking levels consider the worst-case measured altimeter model across temperature and Unit variations.					

Table 72: Margin for Interference Tolerance Threshold (ITT) levels between 3.8-4.2 GHz at 200 feet AGL in Table 4 and maximum predicted blocking level for local area medium power non-AAS BS with 6 m BS height in Table 60

Altimeter model	ITT in dBm/MHz for 3.8-4.1 GHz	ITT in dBm/MHz for 4.1-4.2 GHz	Max blocking level simulation in dBm/MHz for 3.85 GHz 4.15 GHz	Margin in dB 3.8-4.1 GHz 4.1-4.2 GHz	
F	-37	-33	-69.6 -64.3 (Table 60 and for 6 m BS height)	32.6	31.3
L	-10	NDA		59.6	-
T	NB	NB		-	-
X	-30	NDA		39.6	-
U	NB	NB		-	-
Y	-34	NDA		35.6	-

For Altimeter F the U&T_f with 0 dB is applied since the blocking levels consider the worst-case measured altimeter model across temperature and Unit variations.

Table 73: Margin for Interference Tolerance Threshold (ITT) levels between 3.8-4.2 GHz at 1000 feet AGL in Table 5 and maximum predicted blocking level for local area medium power non-AAS BS with 30 m height in Table 61

Altimeter model	ITT in dBm/MHz for 3.8-4.1 GHz	ITT in dBm/MHz for 4.1-4.2 GHz	Max blocking level simulation in dBm/MHz for 3.85 GHz 4.15 GHz	Margin in dB 3.8-4.1 GHz 4.1-4.2 GHz	
F	-42	-39	-83.6 -78.3 (Table 61 and for 30 m BS height)	41.6	39.3
L	-9	NDA		74.6	-
T	-36.9	-39.8		46.7	38.5
X	-38	NDA		45.6	-
U	NB	NB		-	-
Y	-43	NDA		40.6	-

For Altimeter F the U&T_f with 0 dB is applied since the blocking levels consider the worst-case measured altimeter model across temperature and Unit variations.

Table 74: Margin for Interference Tolerance Threshold (ITT) levels between 3.8-4.2 GHz at 1000 feet AGL in Table 5 and maximum predicted blocking level for local area medium power non-AAS BS with 6 m height in Table 61

Altimeter model	ITT in dBm/MHz for 3.8-4.1GHz	ITT in dBm/MHz for 4.1-4.2 GHz	Max blocking level simulation in dBm/MHz for 3.85 GHz 4.15 GHz	Margin in dB 3.8-4.1 GHz 4.1-4.2 GHz	
F	-42	-39	-84.4 -79 (Table 61 and for 6 m BS height)	42.4	40
L	-9	NDA		75.4	-
T	-36.9	-39.8		47.5	39.2

Altimeter model	ITT in dBm/MHz for 3.8-4.1GHz	ITT in dBm/MHz for 4.1-4.2 GHz	Max blocking level simulation in dBm/MHz for 3.85 GHz 4.15 GHz	Margin in dB	
				3.8-4.1 GHz	4.1-4.2 GHz
X	-38	NDA		46.4	-
U	NB	NB		-	-
Y	-43	NDA		41.4	-

For Altimeter F the U&T_f with 0 dB is applied since the blocking levels consider the worst-case measured altimeter model across temperature and Unit variations.

A6.3.3.4 Tables for unwanted emission from AAS BS and margins for Radio Altimeter ITTs

Table 75: Margin for Interference Tolerance Threshold (ITT) levels between 4.2 to 4.4 GHz at 200 and 1000 feet AGL in Table 6 and maximum predicted unwanted emission level for local area medium power AAS BS with 30 m height and fc = 4.15 GHz in Table 62 and Table 63

Altimeter model	ITT in dBm/MHz for 200 feet	ITT in dBm/MHz for 1000 feet	Max interference level simulation in dBm/MHz for	Margin in dB	
				200 feet	1000 feet
F	-73	-85	200 feet: -100.4 dBm/MHz (Table 48 for 30 m BS height) 1000 feet: -98 dBm/MHz (Table 49 for 30 m BS height)	27.4	13
L	-81	-81		19.4	17
T	-66.8	-71.8		33.6	26.2
X	-63.8	-83.2		36.6	14.8
U	NB	NB		-	-
Y	-70	-84		30.4	14

Note: For Altimeter F the U&T_f with 4 dB is applied as there is lack of information about unit to unit variations for interference in the altimeter band.
 Note: For Altimeter L and X, the average thresholds provided by the manufacturer are used with U&T_f 4 dB unit to unit variations as a conservative assumption as there is no individual information available on unit-to-unit/ temperature variations. While a standard deviation is provided, there is no basis for considering a 3σ variation which can significantly overestimate the thresholds compared to the measured worst-case altimeter performance. This is evident especially for Altimeter X where the standard deviation is much larger as compared to measurements at other lower heights.

Table 76: Margin for Interference Tolerance Threshold (ITT) levels between 4.2 to 4.4 GHz at 200 and 1000 feet AGL in Table 6 and maximum predicted unwanted emission level for local area medium power AAS BS with 6 m height and fc = 4.15 GHz in Table 62 and Table 63

Altimeter model	ITT in dBm/MHz for 200 feet	ITT in dBm/MHz for 1000 feet	Max interference level simulation in dBm/MHz for	Margin in dB	
				200 feet	1000 feet
F	-73	-85	200 feet: -84.1 dBm/MHz (Table 48 for 6 m BS height) 1000 feet: -98.8 dBm/MHz (Table 49 for 6 m BS height)	11.1	13.8
L	-81	-81		3.1	17.8
T	-66.8	-71.8		17.3	27
X	-63.8	-83.2		20.3	15.6
U	NB	NB		-	-

Altimeter model	ITT in dBm/MHz for 200 feet	ITT in dBm/MHz for 1000 feet	Max interference level simulation in dBm/MHz for	Margin in dB	
				200 feet	1000 feet
Y	-70	-84		14.1	14.8

For Altimeter F the U&Tf with 4 dB is applied as there is lack of information about unit-to-unit variations for interference in the altimeter band.
 For Altimeter L and X, the average thresholds provided by the manufacturer are used with U&Tf 4 dB unit to unit variations as a conservative assumption as there is no individual information available on unit-to-unit/ temperature variations. While a standard deviation is provided, there is no basis for considering a 3σ variation which can significantly overestimate the thresholds compared to the measured worst-case altimeter performance. This is evident especially for Altimeter X where the standard deviation is much larger as compared to measurements at other lower heights.

A6.3.3.5 Tables for unwanted emission from non-AAS BS and margins for Radio Altimeter ITTs

Table 77: Margin for Interference Tolerance Threshold (ITT) levels between 4.2 to 4.4 GHz at 200 and 1000 feet AGL in Table 6 and maximum predicted unwanted emission level for local area medium power non-AAS BS with 30 m height and fc = 4.15 GHz in Table 64 and Table 65

Altimeter model	ITT in dBm/MHz for 200 feet	ITT in dBm/MHz for 1000 feet	Max interference level simulation in dBm/MHz for	Margin in dB	
				200 feet	1000 feet
F	-73	-85	200 feet: -109.9 dBm/MHz (Table 64 for 30 m BS height)	36.9	17.3
L	-81	-81		28.9	21.3
T	-66.8	-71.8		43.1	30.5
X	-63.8	-83.2		46.1	19.1
U	NB	NB	1000 feet: -102.3 dBm/MHz (Table 65 for 30 m BS height)	-	-
Y	-70	-84		39.9	18.3

For Altimeter F the U&Tf with 4 dB is applied as there is lack of information about unit to unit variations for interference in the altimeter band.
 For Altimeter L and X, the average thresholds provided by the manufacturer are used with U&Tf 4 dB unit to unit variations as a conservative assumption as there is no individual information available on unit-to-unit/ temperature variations. While a standard deviation is provided, there is no basis for considering a 3σ variation which can significantly overestimate the thresholds compared to the measured worst-case altimeter performance. This is evident especially for Altimeter X where the standard deviation is much larger as compared to measurements at other lower heights.

Table 78: Margin for Interference Tolerance Threshold (ITT) levels between 4.2 to 4.4 GHz at 200 and 1000 feet AGL in Table 6 and maximum predicted unwanted emission level for local area medium power non-AAS BS with 6 m height and fc = 4.15 GHz in Table 64 and Table 65

Altimeter model	ITT in dBm/MHz for 200 feet	ITT in dBm/MHz for 1000 feet	Max interference level simulation in dBm/MHz for	Margin in dB	
				200 feet	1000 feet
F	-73	-85	200 feet: -88.3 dBm/MHz (Table 64 for 6 m BS height)	15.3	18
L	-81	-81		7.3	22
T	-66.8	-71.8		21.5	31.2
X	-63.8	-83.2	1000 feet: -103 dBm/MHz (Table 65 for 6 m BS height)	24.5	19.8
U	NB	NB		-	-
Y	-70	-84		18.3	19

Altimeter model	ITT in dBm/MHz for 200 feet	ITT in dBm/MHz for 1000 feet	Max interference level simulation in dBm/MHz for	Margin in dB 200 feet 1000 feet
<p>For Altimeter F the $U&T_f$ with 4 dB is applied as there is lack of information about unit to unit variations for interference in the altimeter band.</p> <p>For Altimeter L and X, the average thresholds provided by the manufacturer are used with $U&T_f$ 4 dB unit to unit variations as a conservative assumption as there is no individual information available on unit-to-unit/ temperature variations. While a standard deviation is provided, there is no basis for considering a 3σ variation which can significantly overestimate the thresholds compared to the measured worst-case altimeter performance. This is evident especially for Altimeter X where the standard deviation is much larger as compared to measurements at other lower heights.</p>				

ANNEX 7: (STUDY F) STUDY OF MFCN 3.4-3.8 GHZ AND WBB LMP 3.8-4.2 GHZ VS RADIO ALTIMETERS WITH PARAMETER SET 1

A7.1 INTERFERENCE STUDY FOR RADIO ALTIMETERS IN THE PRESENCE OF MFCN 3.4-3.8 GHZ AND WBB LMP 3.8-4.2 GHZ

This study reports the results of an analysis of the potential interference from MFCN BSs in the 3.4-3.8 GHz and WBB LMP system in the 3.8-4.2 GHz frequency ranges into a set of Radio Altimeters (RAs) operating in the 4.2-4.4 GHz frequency range.

A7.2 PARAMETERS

The parameters and antenna used in the baseline part of this study for the Radio Altimeters are from Parameter Set 1.

The analysis is made for two interference mechanisms:

- 1 Blocking of the RAs where the interference signal is in-band wanted MFCN/WBB emissions into the RA out-of-band susceptibility.
For blocking the parameters are shown below

Table 79: Blocking parameters and resulting ITT levels for the different RA models

Altimeter Type/frequency band		F	L	T	X	U	Y
200 feet break point							
< 3.8 GHz	dBm/MHz	-30	0	-21.2	-20	-21.2	-29
3.8-4.1 GHz		-35	-8	-29.9	-28	-19.8	-28
4.1-4.2 GHz		-31	nda	-19.8	nda	-19.8	nda
1000 feet break point							
< 3.8 GHz	dBm/MHz	-34	0	-21.9	-24	-21.2	-35
3.8-4.1 GHz		-40	-7	-30.9	-36	-19.8	-37
4.1-4.2 GHz		-37	nda	-33.8	nda	-19.8	nda
BTIf	dB	1	1	1	1	1	1
EEf	dB	1	1	1	1	1	1
U&Tf	dB	4	0	4	0	4	4
ITT 200 feet							
< 3.8 GHz	dBm/MHz	-36	-2	-27.2	-22	-27.2	-35
3.8-4.1 GHz		-41	-10	-35.9	-30	-25.8	-34
4.1-4.2 GHz		-37	nda	-25.8	nda	-25.8	nda
ITT 1000 feet							
< 3.8 GHz	dBm/MHz	-40	-2	-27.9	-26	-27.2	-41
3.8-4.1 GHz		-46	-9	-36.9	-38	-25.8	-43
4.1-4.2 GHz		-43	nda	-39.8	nda	-25.8	nda

- 2 Desensitisation of the RAs where the interference signal is out-of-band unwanted MFCN/WBB emissions into the RA in-band reception.
For desensitisation, the ITT levels are shown below.

Table 80: Parameters and Interference Tolerance Thresholds for the different RA models

Altimeter Type		F	L	T	X	U	Y
200 feet break point	dBm/MHz	-67	-79	-60.8	-61.1	N/A	-64
1000 feet break point	dBm/MHz	-79	-79	-65.8	-91.5	N/A	-78
BTIf	dB	1	1	1	1	1	1
EEf	dB	1	1	1	1	1	1
U&Tf	dB	4	0	4	0	4	4
ITT 200 feet	dBm/MHz	-73	-81	-66.8	-63.1	#VALUE!	-70
ITT 1000 feet	dBm/MHz	-85	-81	-71.8	(-93.5)	#VALUE!	-84

The study focuses on a rural BS using AAS (8x8) with Sub Arrays (mechanical downtilt 3° and 10° electrical tilt range) having a maximum power of 78 dBm and 51 dBm respectively. None of the less restrictive values of the ITTs was used, and hence values are a bit more conservative than may have been required.

A7.3 METHODOLOGY

The interference analysis is based on a model which simulates an aeroplane approaching a runway starting at 1000 feet in altitude with a constant glide slope of 2.625° to touchdown.

The model records the highest level of the interference signal that occurs at any point of the glide slope, from every possible BS location. The recorded levels are then compared to the interference thresholds of the different types of Radio Altimeters and displayed as a set of margin contours. Whilst the model includes (Visualyse)stochastic variables there are no probabilities or time dependent results included in this analysis. It should be noted that the study is not a risk analysis.

For the blocking studies, and for the WBB LMP desensitisation study in the 4.1-4.2 GHz range, the time variability of the MFCN and WBB networks has been taken into account and eliminated by the generation of a precalculated envelope of the antenna gain. The envelope results from the full simulation of the behaviour of the AAS antenna as it electronically steers towards a UE on a cell sector. The sector azimuth is randomised. Hence the resulting output is not time dependent and only dependent on elevation angle.

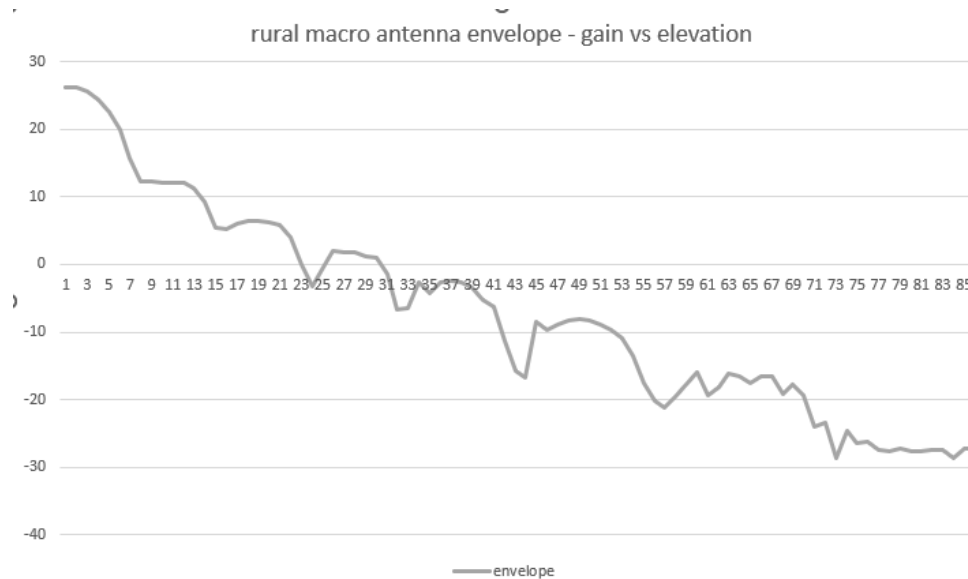

Figure 81: Maximum antenna gains from the omnidirectional ‘spin top’ envelope pattern for a rural MFCN AAS SA BS

The AAS antennas have been simulated within a MFCN service sector using the parameters for the antenna as boundary, then post processed to a max envelope and finally implemented as an elevation pattern on an omnidirectional (azimuth) so will take the shape of a ‘spin top’ providing the maximum emission in all direction within the specified vertical elevation.

A7.3.1 Baseline

In the first part of the study (baseline), the calculation focuses on margins at 1000 feet and 200 feet because these are the points where data have been provided. From each test point on a regular grid below the RA the single-entry interference that would be seen from an MFCN/WBB base station is calculated and compared to the threshold (ITT). From the resulting grid of data contours of equal margin are extracted.

Due to the setup of the simulation, the results in this first case are symmetric about the sub-RA point and the resulting contours are exactly circular in theory. Some small differences from circular contours may be seen due to the finite resolution of the data grid.

A7.3.2 Sensitivity analysis

The sensitivity analysis is performed via a simulation in which the aeroplane moves along a glide path of constant inclination. The simulation is initialised by the creation of a regular grid of points and the definition of the glide path as latitude, longitude, height triplets. Then at each sample point in the simulations:

- Update aeroplane position based on a 2.625° glide path towards the runway;
- Deploy an MFCN BS/WBB BS at each point on the grid;
- Calculate the single entry interference (I) from each point on the grid;
- Compare the Interference to the (altitude dependent) threshold (T) and compute the margin T-I at each point on the grid;
- The Margin is compared to the one stored at the previous timestep and the lower value.

When each point on the glide path has been sampled, the result is a grid of worst case margins from which contours of equal M are extracted. There are potential interference issues only if $M < 0$ dB.

In the sensitivity part an assumed interpolation of the ITTs between 1000 and 200 feet is applied.

Between 200 feet and touchdown, the physical elements which change are further discussed, and the elements incorporated into an extrapolation.

Using these elements for 'below 200 feet' a sensitivity analysis is provided for Parameter Set 2 including a comparison of Set 2 with the omni antenna and Set 2 with the antenna in Report ITU-R M.2319 with addition of a Set 1 with omni antenna to have the full picture to determine if the parameters or the antennas are the most critical element.

The study is focussing on the results as simulated. However, a yellow 6 dB margin contour which closely approximates the Aeronautical Safety Margins incorporated in the study which may be considered by authorities requiring this. It should be noted that the yellow 6 dB margin is only visible in the sensitivity analysis sections because of the larger positive margins in the baseline study sections.

A7.4 BASELINE FOR SET 1 PARAMETERS

This section reports the results of the margins calculated at 200 feet and 1000 feet for both the blocking and the desensitisation cases for MFCN and WBB LMP.

Results are presented as contours of equal margin against a grid with a defined graticule resolution, allowing an estimate of distance from the sub-RA point to be made in each azimuth. In these initial cases the contours should be exactly circular and any deviations from this are due to the artefacts of the contour extraction algorithm as a result of the finite resolution of the data.

All the contour plots in the baseline section use a grid of 100 m although the actual plot may vary in size, this because they have been copied as screen shots over time.

The contours will of course reflect the AAS antenna's maximums in elevation, leading in many cases to concentric circles.

A7.4.1 Blocking (out of band RA by in-band MFCN) 200 feet

For this section, the grid is 100 m, RA antenna is 0 dBi (see Report ITU-R M.2319), 60° degree beamwidth, ±15° pitch and roll,

MFCN is 78 dBm/100 MHz *e.i.r.p.* from AAS SA BS Spin top, antenna peak gain 26 dBi.

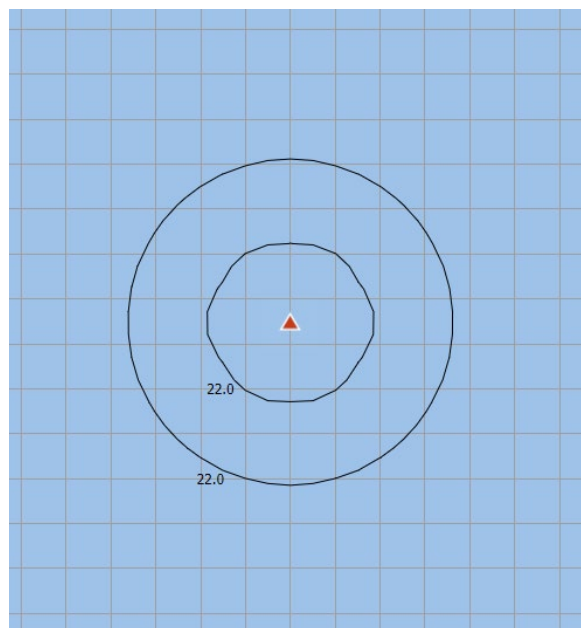

Figure 82: Margin in dB for RA model F with an ITT of = -36 dBm/MHz, grid = 100 m

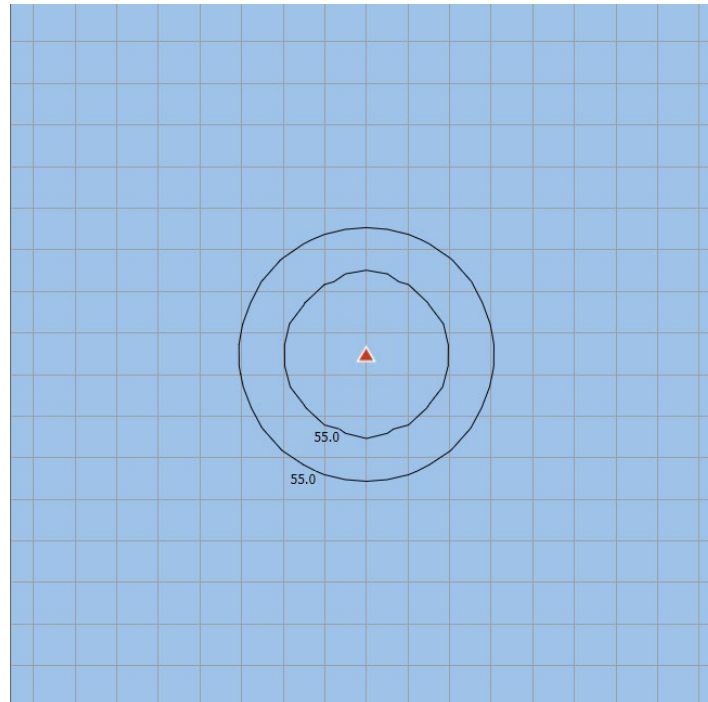

Figure 83: Margin in dB for RA model L with an ITT of -2 dBm/MHz, grid = 100 m

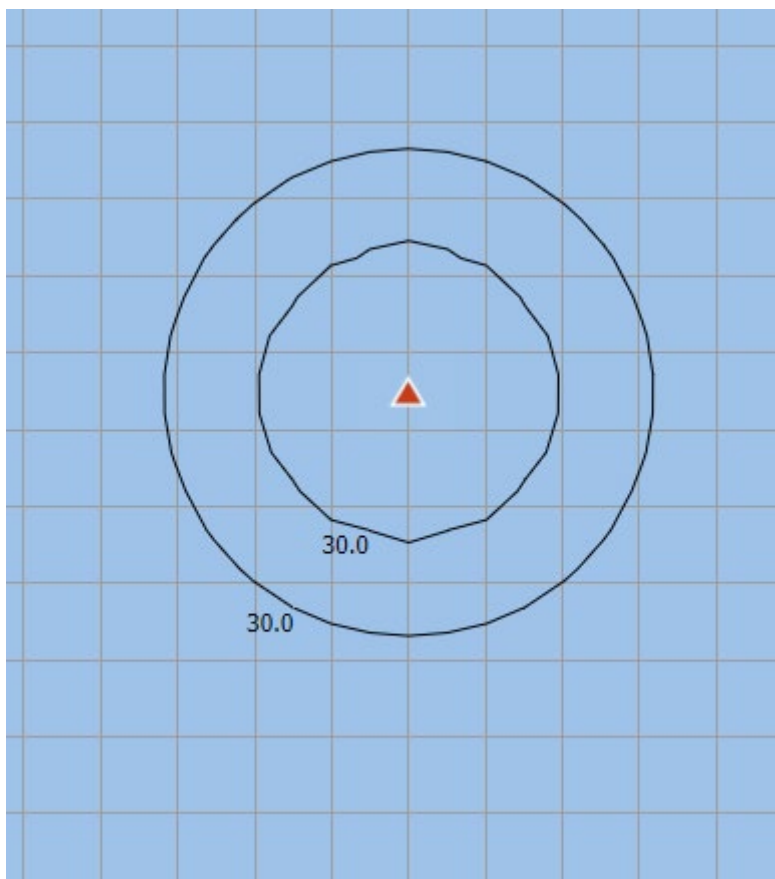

Figure 84: Margin in dB for RA model T with an ITT of -27.2 dBm/MHz, grid = 100 m

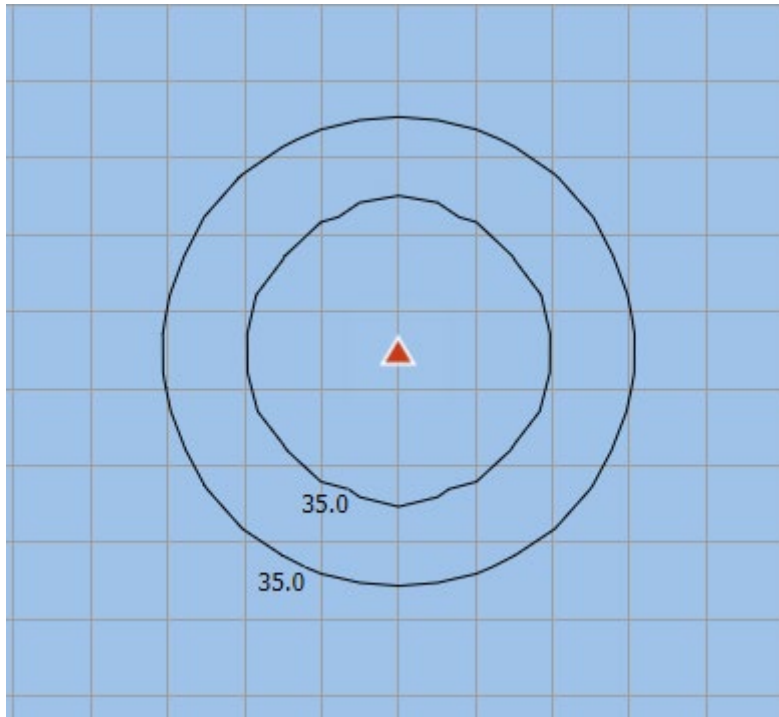

Figure 85: Margin in dB for RA model X with an ITT of -22 dBm/MHz, grid = 100 m

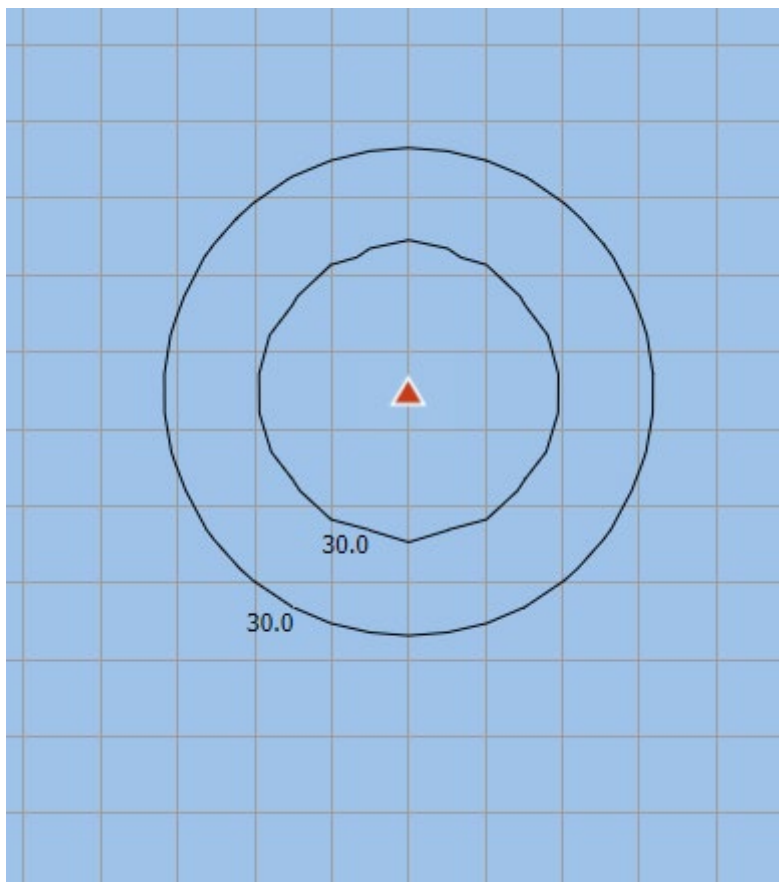

Figure 86: Margin in dB for RA model U with an ITT of -27.2 dBm/MHz, grid = 100 m

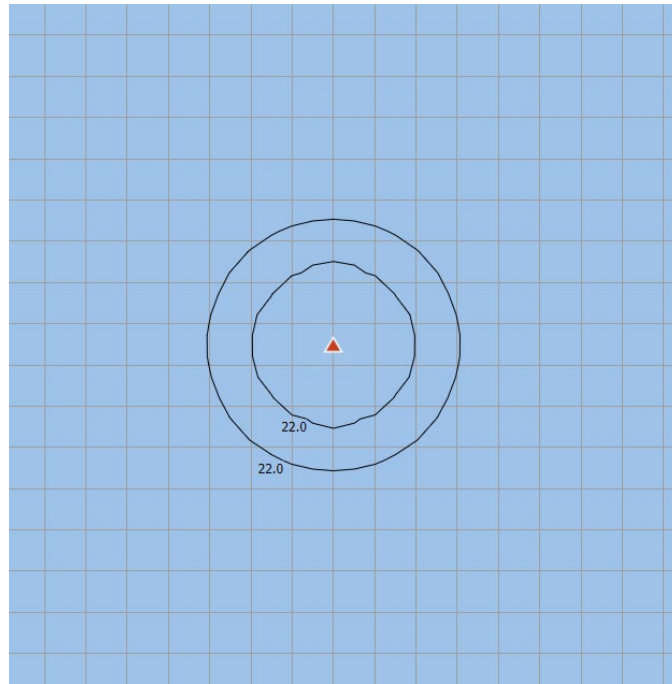

Figure 87: Margin in dB for RA type Y with an ITT of -35 dBm/MHz, grid = 100 m

A7.4.1.1 Summary of MFCN blocking at 200 feet

From the above set of results, it can be seen that at 200 feet, the most susceptible to blocking from MFCN is RA model F, (whilst both F and Y has the same margin of 22 dB, the margin for F is located further away from the aircraft than Y) however there is still a large margin and hence no risk of interference.

A7.4.2 Blocking (out of band RA by in-band MFCN) 1000 feet

For this section, the grid is 100 m, RA antenna is 0 dBi [22], 60° degree beamwidth, ±15° pitch and roll.

MFCN is 78 dBm/100 MHz *e.i.r.p.* from AAS SABS Spin top, antenna peak gain 26 dBi.

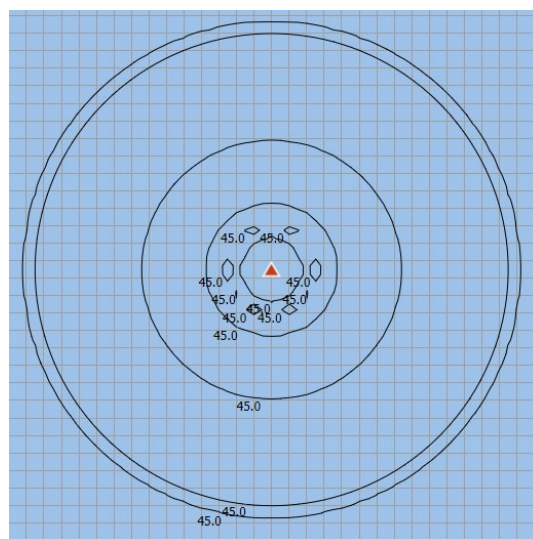

Figure 88: Margin in dB for RA model Y with an ITT of -41 dBm/MHz, grid = 100MFCN Interference (unwanted emissions)

A7.4.2.1 Summary of MFCN blocking at 1000 feet

From Table 2, it can be seen that at 1000 feet, the most susceptible to blocking from MFCN is Radio Altimeter type Y, however there is still a large margin and hence no risk of interference

A7.4.3 Blocking (out of band RA by in-band WBB LMP) 200 feet

Grid is 100 m, RA antenna is 0 dBi [22], 60° beamwidth, ±15° pitch and roll.

WBB LMP is 42 dBm *e.i.r.p.* in 10 MHz channel, from AAS SA BS Spin top, antenna peak gain 26 dBi.

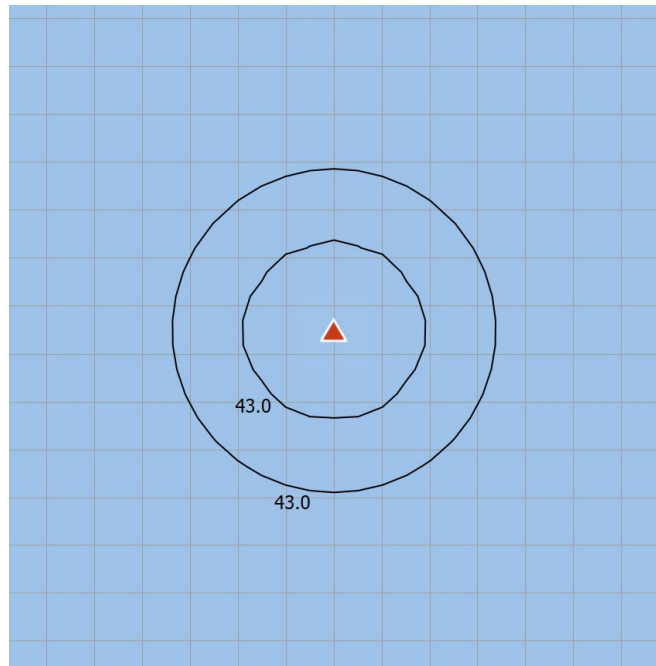

Figure 89: Margin in dB for RA model F with an ITT of -41 dBm/MHz, grid = 100 m

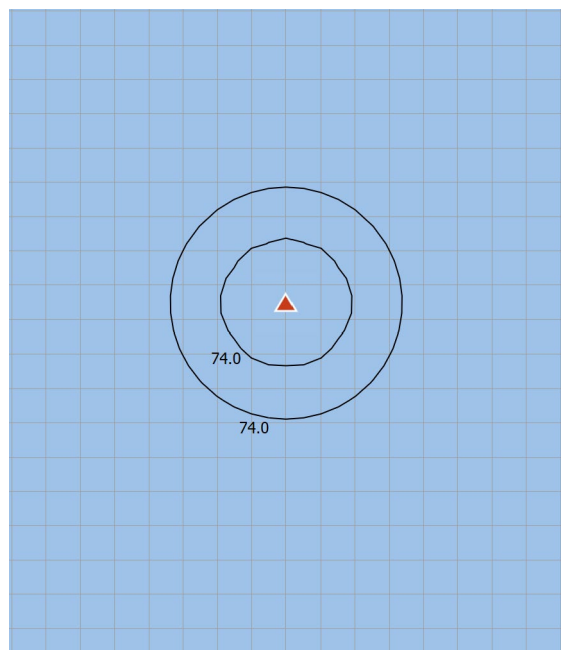

Figure 90: Margin in dB for RA Model L, with an ITT of -10 dBm/MHz, grid = 100 m

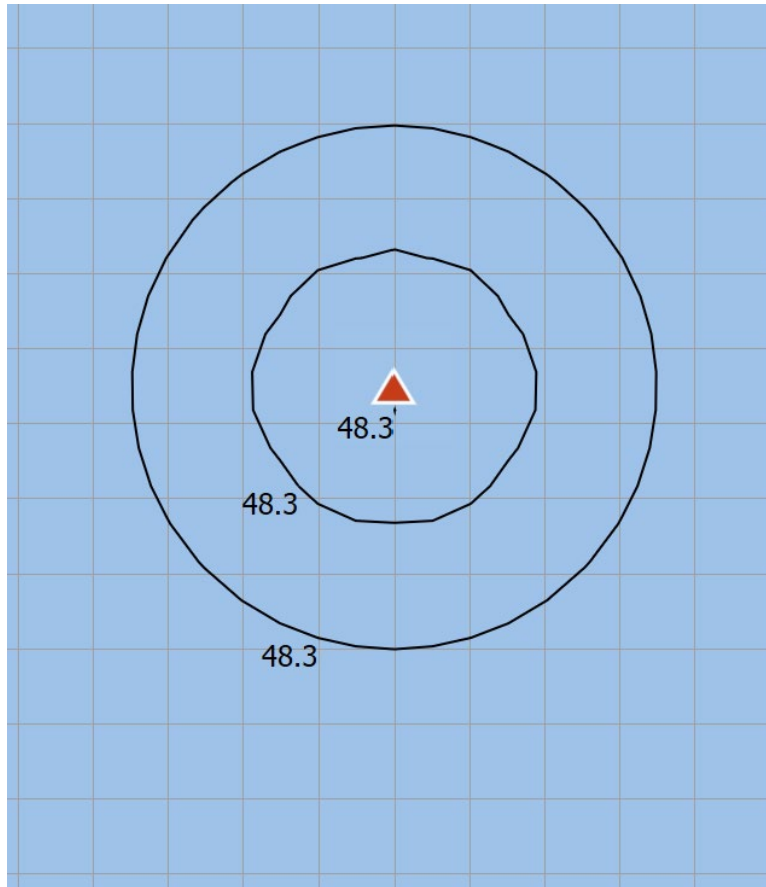

Figure 91: Margin in dB for RA Model T with an ITT of -35.9 dBm/MHz, grid = 100 m

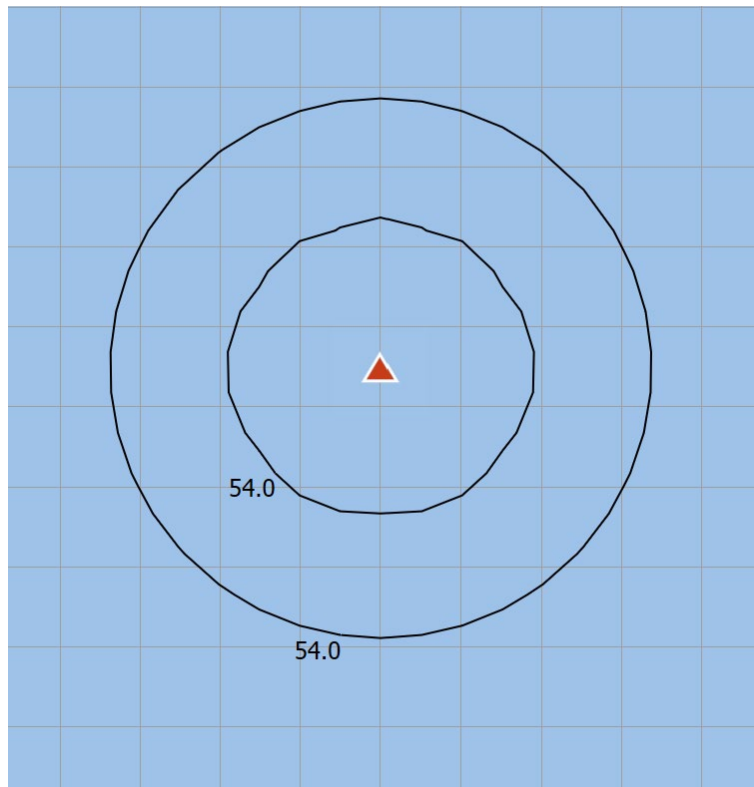

Figure 92: Margin in dB for RA Model X with an ITT of -30 dBm/MHz, grid = 100 m

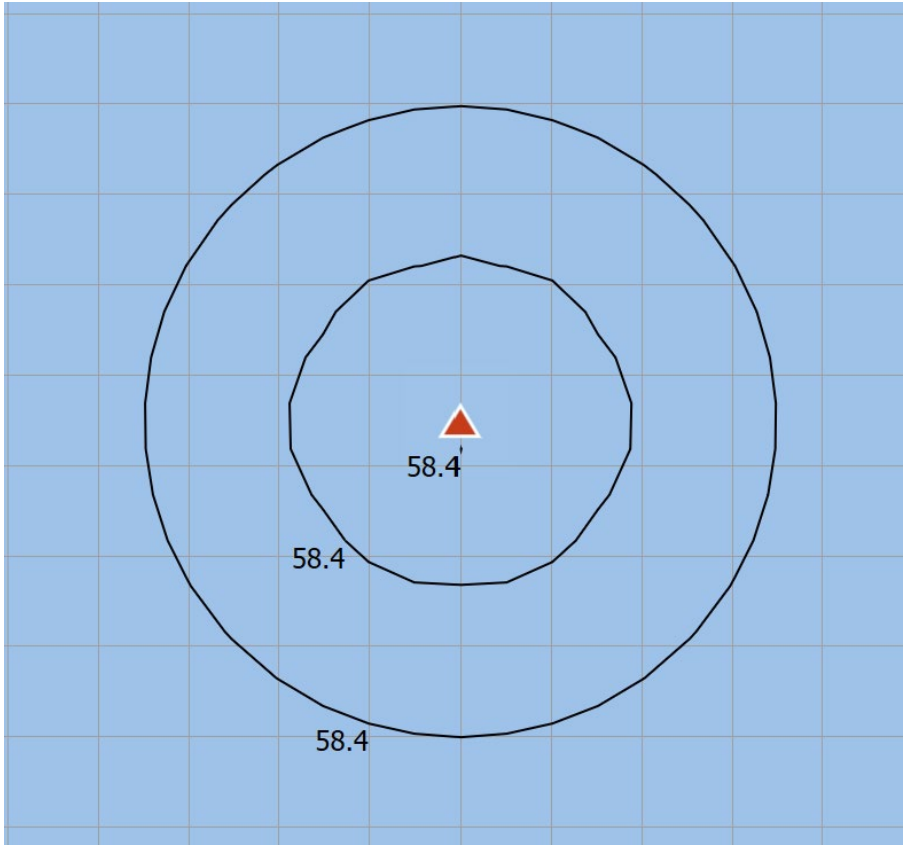

Figure 93: Margin in dB for RA Model U with an ITT of -25.8 dBm/MHz, grid = 100 m

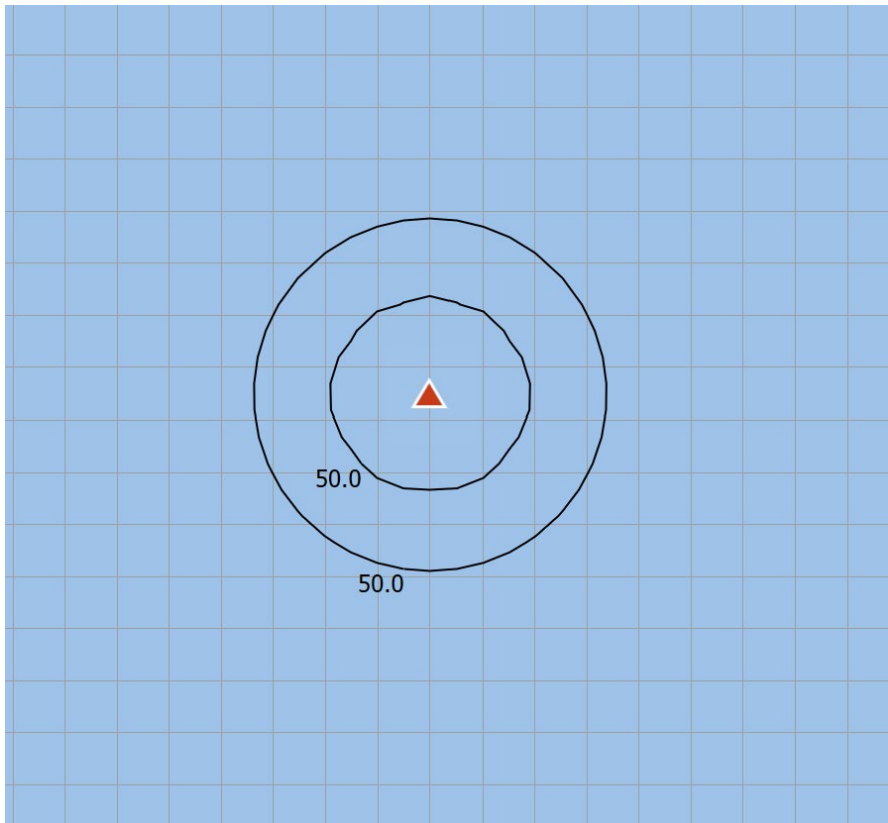

Figure 94: Margin in dB for RA Model Y with an ITT of = -34 dBm/MHz, grid = 100 m

A7.4.3.1 Summary of WBB LMP at 200 feet

From the above set of results, it can be seen that at 200 feet, the most susceptible to blocking from WBB LMP is RA model F, however there is still a large margin and hence no risk of interference.

A7.4.4 Blocking (out of band RA by in-band WBB LMP) 1000 feet

Grid is 100 m, RA antenna is 0 dBi [23], 60° beamwidth, ±15° pitch and roll.

WBB LMP is 42 dBm e.i.r.p. in 10 MHz channel, from AAS SA BS Spin top, antenna peak gain 26 dBi.

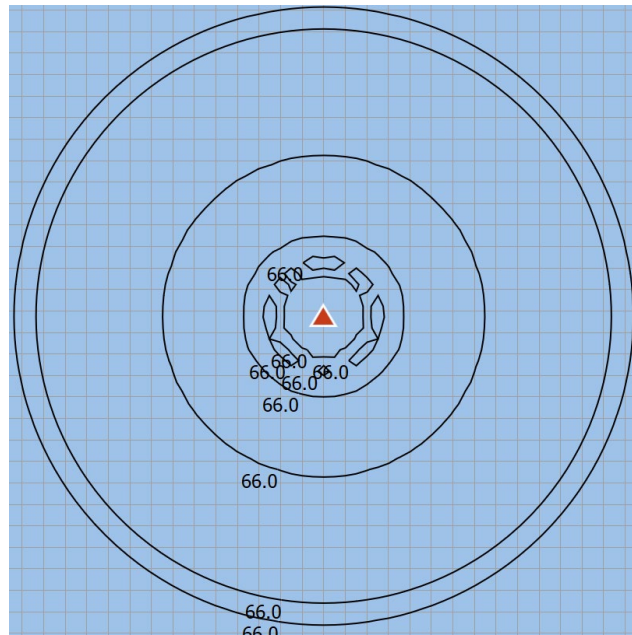

Figure 95: Margin in dB for RA model F, with an ITT of -46 dBm/MHz, grid = 100 m

A7.4.4.1 Summary of WBB LMP Blocking of RAs at 1000 feet

From Table 1 it can be noted that at 1000 feet, the most susceptible to blocking from WBB LMP (above 3.8 GHz) is RA t model F, however there is still a large margin and hence no risk of interference.

The figure shows a good 2D projection of the AAS SABS 'spintop' antenna, and an interference pattern as a result of the granularity of the data map grid and the BS grid leading to tiny variations of the recorded signal such that it at some points is just about strong enough for the 66 dB margin and at other points not.

A7.4.5 Desensitisation, in-band RA by out of band MFCN and WBB LMP unwanted emissions 200 feet

In the desensitisation cases the MFCN/WBB LMP antenna does not perform in full AAS mode for wanted frequencies below 4.1 GHz. In addition, the out of band power is lower than in-band, at -21 dBm/MHz, and relevant bandwidth is the 160 MHz for RA. The MFCN/WBB antenna is modelled as 6.4 dBi omni directional antenna.

Grid is 100 m, RA antenna is 9 dBi [23], 60° beamwidth, ±15° pitch and roll

Figure 96 shows the contour representing 55 dB margin for each of the four RA models that has a specified break point at 200 feet (i.e. ITT).

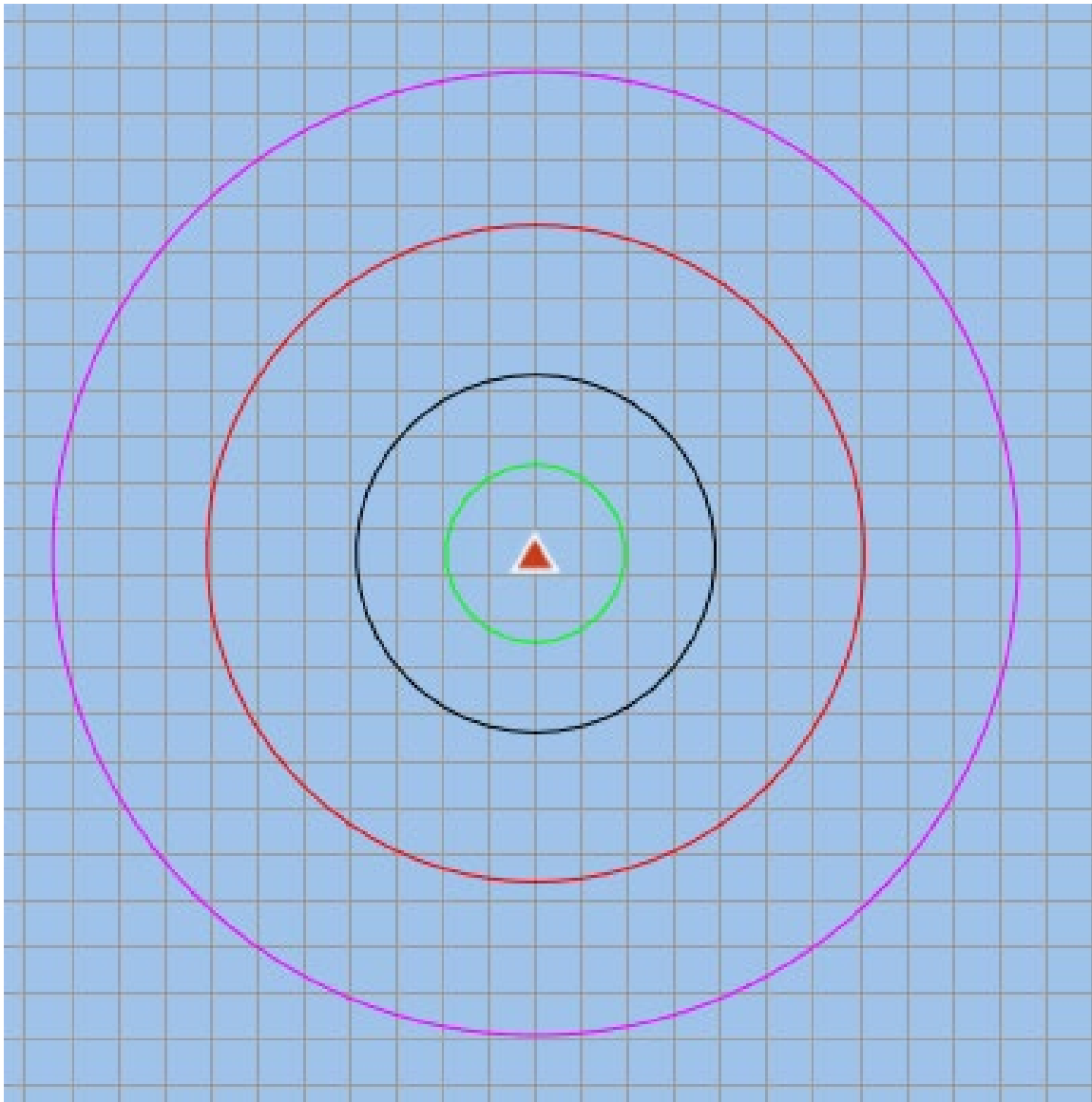

Figure 96: 55 dB margin contours for RA X-green (ITT -63.1 dBm/MHz), T-black (ITT -66.8 dBm/MHz), F-red (ITT -73 dBm/MHz) and L-pink (ITT -81 dBm/MHz), grid = 100 m

A7.4.5.1 Summary Desensitisation of RAs at 200 feet from MFCN and WBB LMP

From the above set of results, it can be seen that at 200 feet, the most susceptible to desensitisation from MFCN and WBB LMP unwanted emissions is RA model L, however there is still a large margin and hence no risk of interference.

A7.4.6 Desensitisation, in-band RA by out of band MFCN and WBB LMP unwanted emissions 1000 feet

Grid is 100 m, RA antenna is 9 dBi [23], 60° beamwidth, ±15° pitch and roll.

Figure 97 shows the contour representing 55 dB margin for each of the four RA models that has a specified break point at 1000 feet (i.e. ITT).

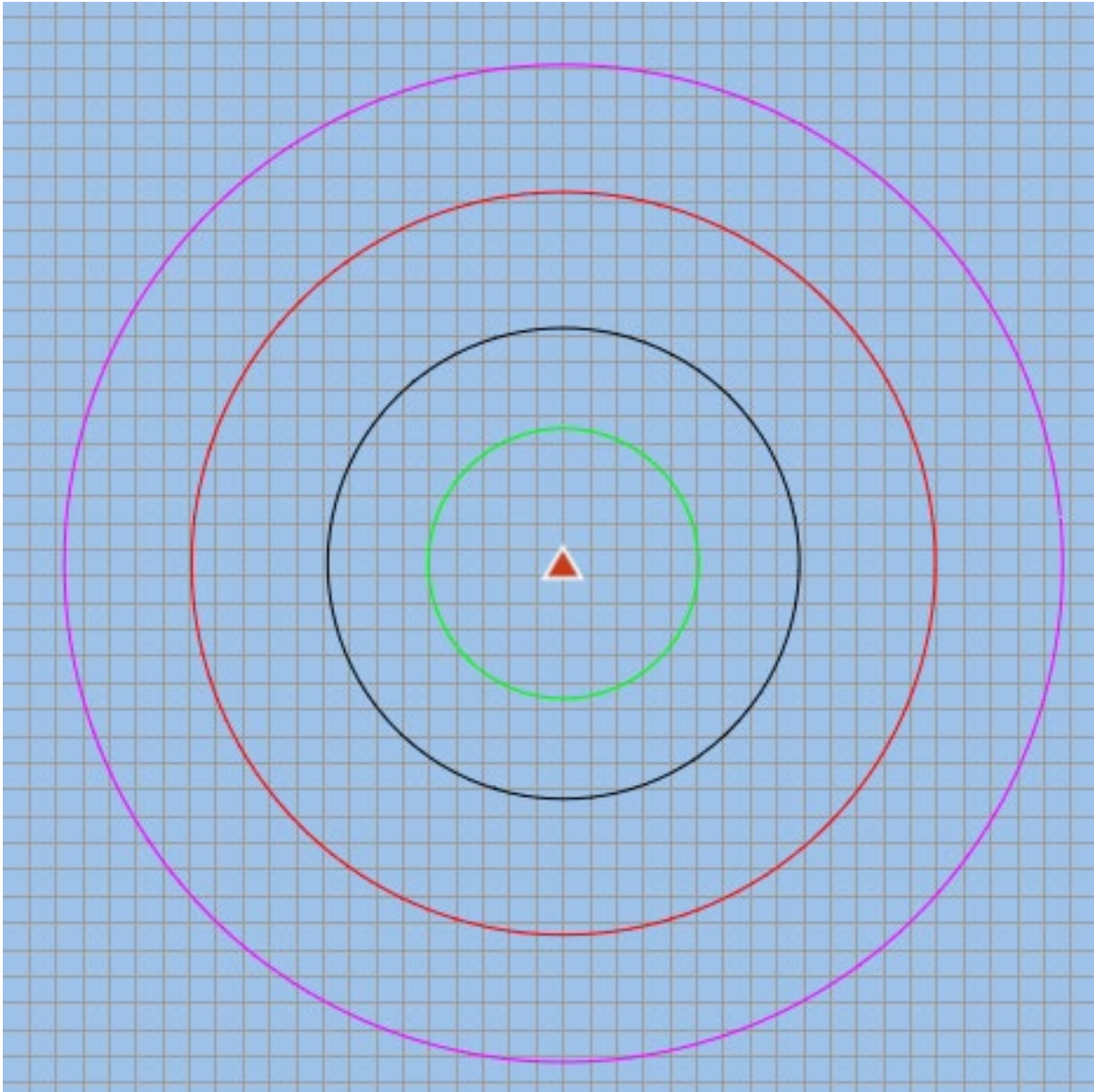

Figure 97: 55 dB margin contours for RA model T- green (ITT -71.8 dBm/MHz), L-black (ITT -81 dBm/MHz), F-red (ITT -85 dBm/MHz) and X-pink (ITT -93.5 dBm/MHz), grid = 100 m

A7.4.6.1 Summary Desensitisation of RAs at 1000 feet from MFCN and WBB LMP

From the above set of results, it can be seen that at 1000 feet, the most susceptible to desensitisation from MFCN and WBB LMP unwanted emissions is RA type model X, however there is still a large margin and hence no risk of interference.

A7.4.7 Desensitisation, in-band RA by out of band WBB LMP unwanted emissions (above 4.1 GHz) at 200 feet

Grid is 100 m, RA antenna is 9 dBi[23], 60° beamwidth, ±15° pitch and roll.

WBB LMP -1 dBm *e.i.r.p.* in a 10 MHz channel = +1 dBW in 160 MHz RA front end, from AAS Spin top, antenna peak gain 26 dBi.

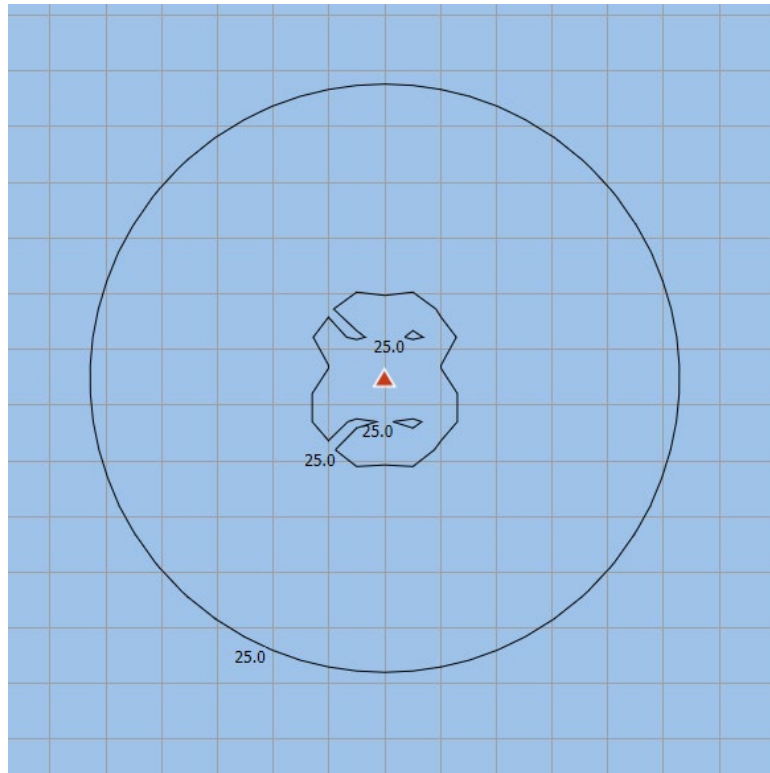

Figure 98: Margin in dB for RA Model X -with an ITT of -63.1 (dBm/MHz), grid = 100 m

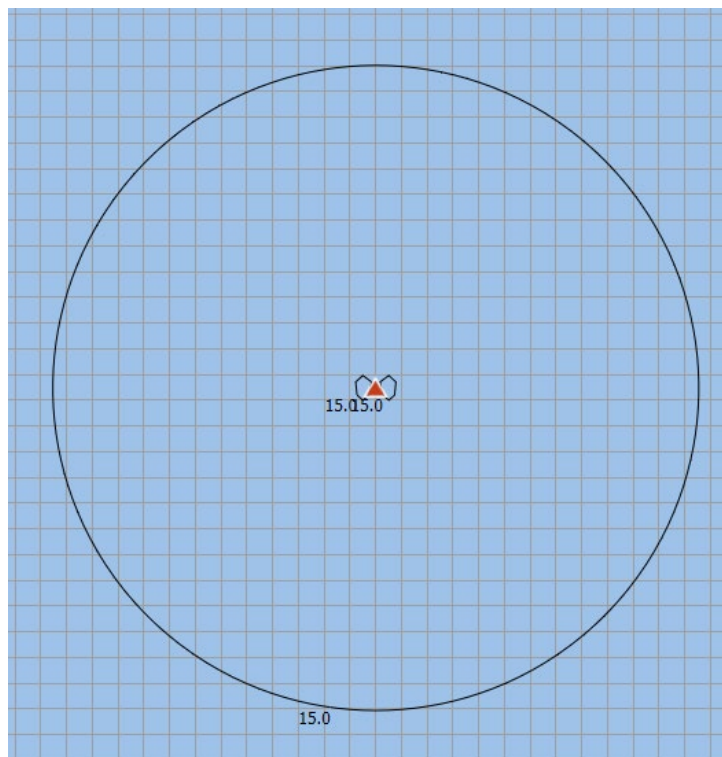

Figure 99: Margin in dB for RA Model L with an ITT of -81 (dBm/MHz), grid = 100 m

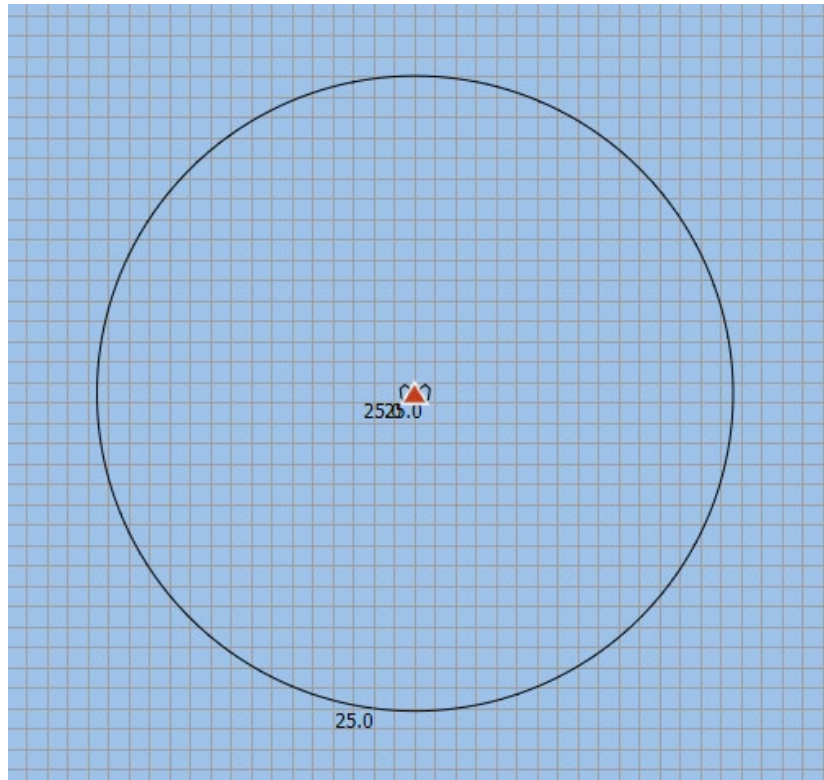

Figure 100: Margins in dB for RA Model F with an ITT of (dBm/MHz), grid = 100 m

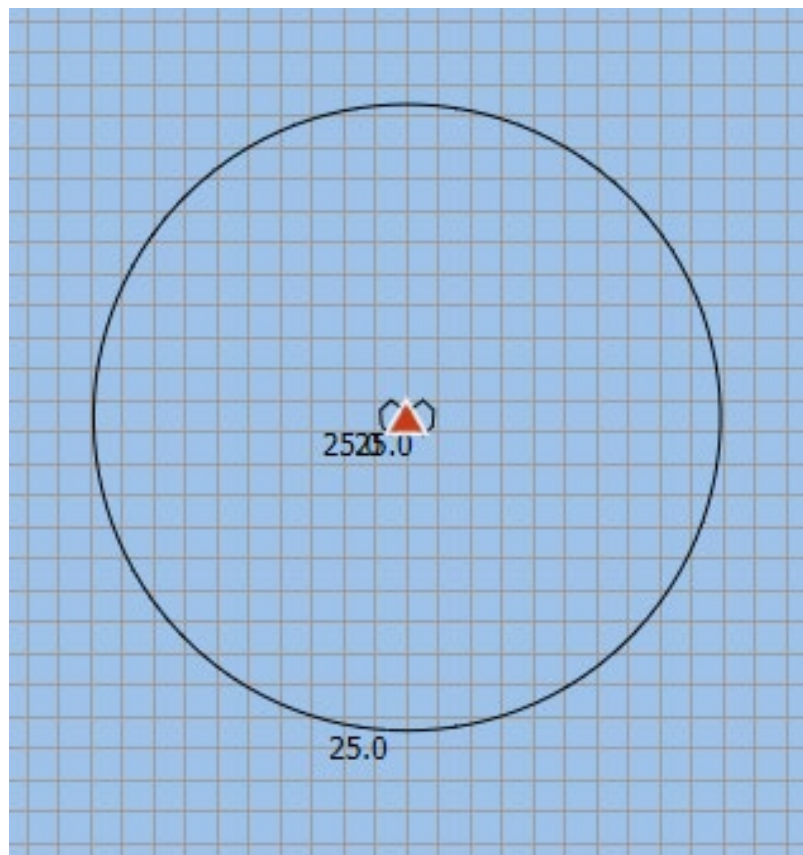

Figure 101: Margins in dB for RA Model T, with an ITT of 66.8 (dBm/MHz), grid = 100 m

A7.4.7.1 Summary Desensitisation of RAs at 200 feet from WBB LMP (above 4.1 GHz) unwanted emissions

From the above set of results, it can be seen that at 200 feet, the most susceptible to desensitisation from WBB LMP (above 4.1 GHz) unwanted emissions is RA type L, however there is still a large margin and hence no risk of interference.

A7.4.8 Desensitisation, in-band RA by out of band WBB LMP (above 4.1 GHz) unwanted emissions 1000 feet

Grid is 100 m, RA antenna is 9 dBi[23], 60° beamwidth, ±15° pitch and roll.

WBB LMP -1 dBm *e.i.r.p.* in a 10 MHz channel = +1 dBW in 160 MHz RA front end, from AAS SA Spin top, antenna peak gain 26 dBi.

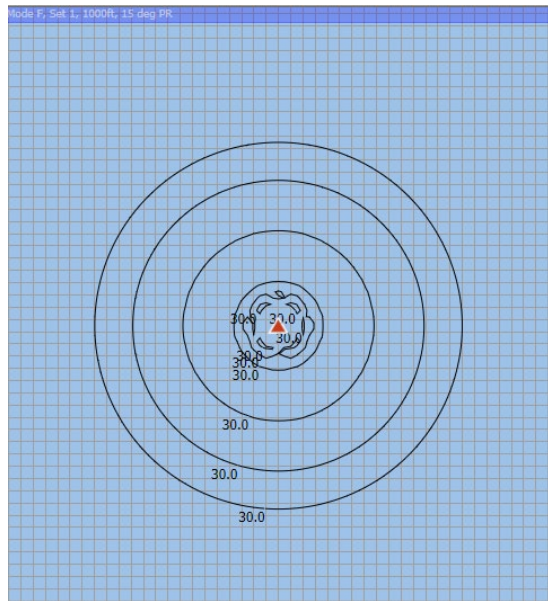

Figure 102: Margins in dB for RA model F with an ITT of -85 dBm/MHz, grid = 100 m

A7.4.8.1 Summary of WBB LMP (above 4.1GHz) Desensitisation of RAs at 1000 feet

From Table 2, it can be seen that at 1000 feet, the most susceptible to desensitisation from WBB LMP (above 4.1 GHz) unwanted emissions is RA type F (with type X being rather ambiguous), however there is still a large margin and hence no risk of interference.

A7.5 SENSITIVITY ANALYSIS

Whilst the first part of the study has focussed on the baseline compliance to the ITMs and resulting ITTs provided, this part of the study is making assumptions of the area between 1000 and 200 feet altitude. Following this, the study discusses what happens in the area below 200 feet down to touch down. Finally, a comparison of the 2 sets of their respective antenna assumptions and parameters is included.

A7.5.1 Assumptions and analysis of 1000 to 200 feet

Interpolation is assumed to be the most representative for the area between 1000 and 200 feet altitude although some RA manufacturers may have deployed different strategies in their design, it would however have been impossible to take individual design strategies into account, also because these are not made readily available.

A7.5.1.1 Blocking (out of band RA by in-band MFCN) 1000 to 200 feet

RA models F and Y have been selected as the most sensitive cases. Model F is the most sensitive at 200 feet, model Y is the most sensitive at 1000 feet.

Table 81: Parameters for RA Models F and Y

Parameter	units		
Altimeter Model		F	Y
RA antenna model		Report ITU-R M.2319 [23]	Report ITU-R M.2319 [23]
RA antenna beamwidth	degrees	60	60
RA antenna peak gain	dBi	0	0
200 feet Break Point	dBm/MHz	-30	-29
1000 feet break point	dBm/MHz	-34	-35
BTIf	dB	1	1
EEf	dB	1	1
U&Tf	dB	4	4
ITM 200 feet	dBm/MHz	-36	-35
ITM 1000 feet	dBm/MHz	-40	-41
Pitch and roll	degrees	±15	±15
IMT Interferer		rural	rural
IMT antenna		AAS with SA	AAS with SA
IMT <i>e.i.r.p.</i>	dBm/100 MHz	78	78
IMT antenna peak gain	dBi	26	26
IMT Antenna Height	m	35	35
TRP	dBm/100	52	52

Parameter	units		
	MHz		
additional cable loss	dB	3	3

In the figures below, green crosses are the runway the red triangle is the 1000 feet point, the red dot is the 200 feet point, the red flag is the touch down point.

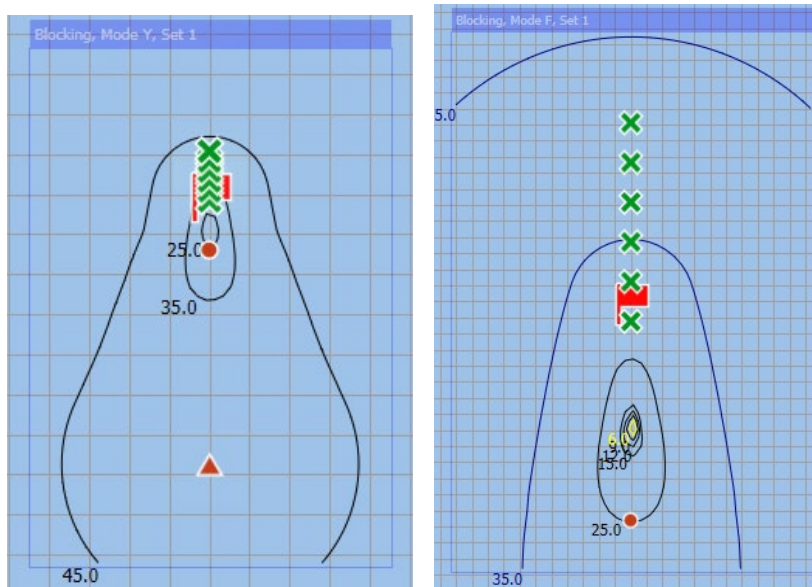

Figure 103: left), grid 1 km, RA model Y; right), grid 100 m RA model F, Blocking

A7.5.1.2 Desensitisation, in-band RA by out of band MFCN emissions 1000 to 200 feet

Note here that the IMT Antenna is assumed to be single element dipole from Recommendation ITU-R M.2101. It is modelled as an omni directional antenna with 6.4 dBi gain.

A TRP of 1 dBm/160 MHz is modelled which combined with an antenna gain of 6.4 dBi gives and *e.i.r.p.* over 70 dB below the blocking case. The Break Point (ITM) values are between 30 and 40 dB tighter so the overall effect is that these cases are 30+dB better than the blocking cases. No interference is recorded. A plot of the RA models F and X are given for reference.

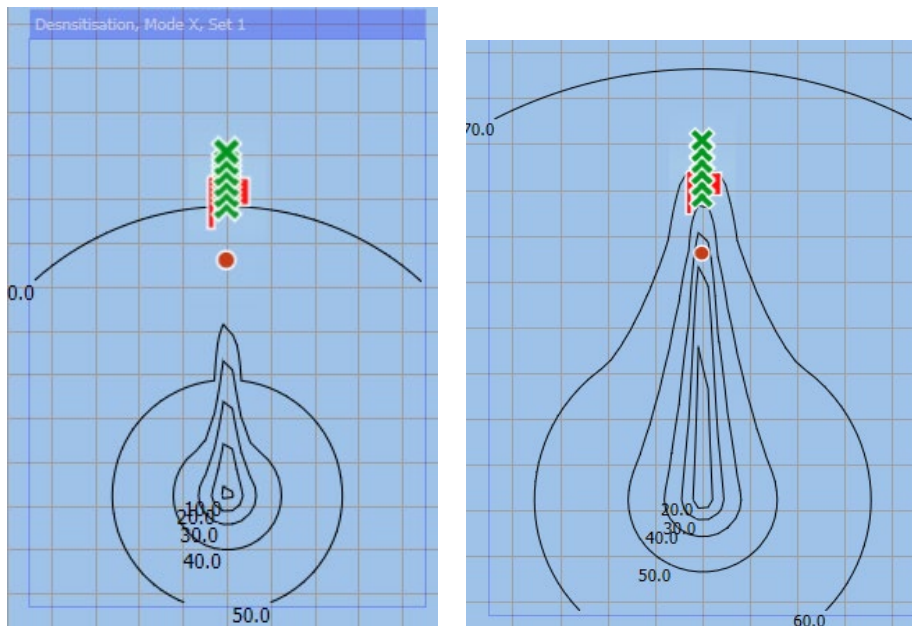

Figure 104: Grid 1 km, Desensitisation, RA model X **Figure 105: Grid 1 km, Desensitisation, RA model F**

A7.5.2 Analysis when RA is below 200 feet

In this section, the impact of different physical phenomena that are bound to impact the ITT of the RA below 200 feet is looked at. These physical attributes are:

- It is expected that the ITT would increase as altitude decreases (down to 20 feet) as a result of increased wanted signal (due to lower path loss), compared to the values of 200 feet.
- The aircraft fuselage shielding attenuation becomes more significant closer to touchdown when the MFCN signal enters the back of the RA antenna. We include additional losses from 100 feet altitude, gradually increasing the fuselage loss from 0 to 6 dB at touchdown;
- The pitch and roll values decrease closer to touch down. Our model starts with $\pm 15^\circ$ at 200 feet, decreasing to $\pm 10^\circ$ at 100ft and 0° at touchdown.

A7.5.3 Blocking when RA is below 200 feet

The impact of these assumptions are illustrated in the following figures for MFCN blocking into RA Type F.

The figures are ordered as follows;

- Worst case – ignoring the physics - using the ITT from 200 feet down to ground;
- Threshold modified and fuselage loss added, 15° pitch and roll at all altitudes;
- Threshold modified, fuselage loss added, and pitch and roll decreased with altitude.

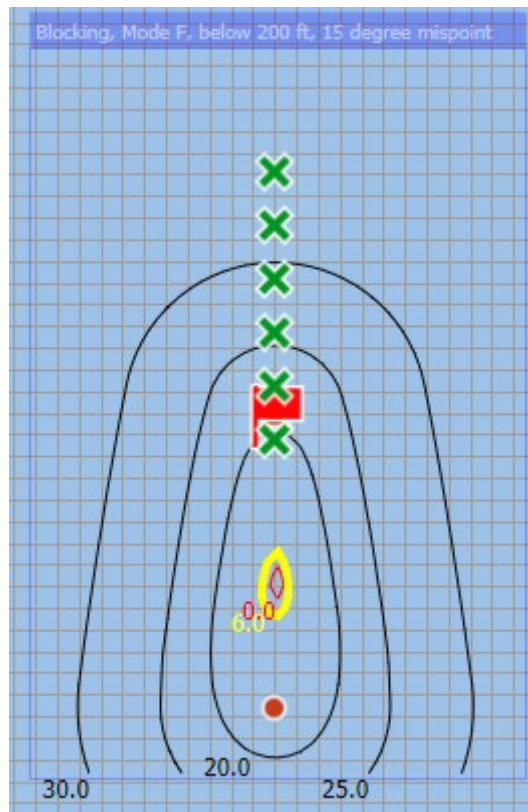

Figure 106: Margins in dB for RA model blocking from MFCN below 200 feet without mitigations grid = 100 m

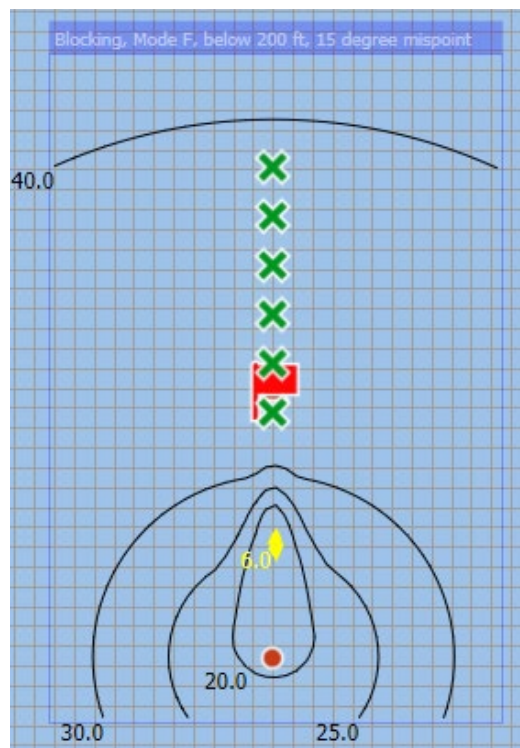

Figure 107: Margins in dB for RA model F for blocking from MFCN below 200 feet with fuselage loss and threshold that increases with decreasing altitude. 15° Pitch and Roll at all altitudes, grid = 100 m

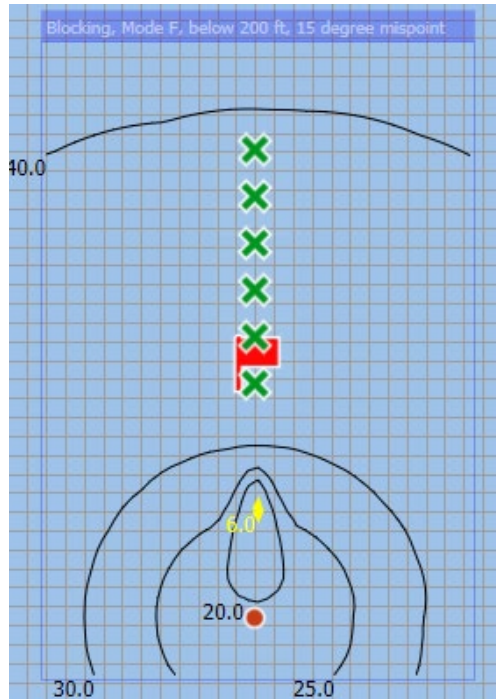

Figure 108: Margins in dB for RA model F for MFCN blocking from MFCN below 200 feet with fuselage loss and threshold that increases with decreasing altitude. Pitch and Roll decreases with decreasing altitude, grid = 100 m

A7.5.4 Desensitisation due to MFCN, RA below 200 feet

The most sensitive case for desensitisation analysis is Altimeter Model L. The threshold given at 200 feet is the same as the one given at 1000 feet and is 12 dB more sensitive than other RA types.

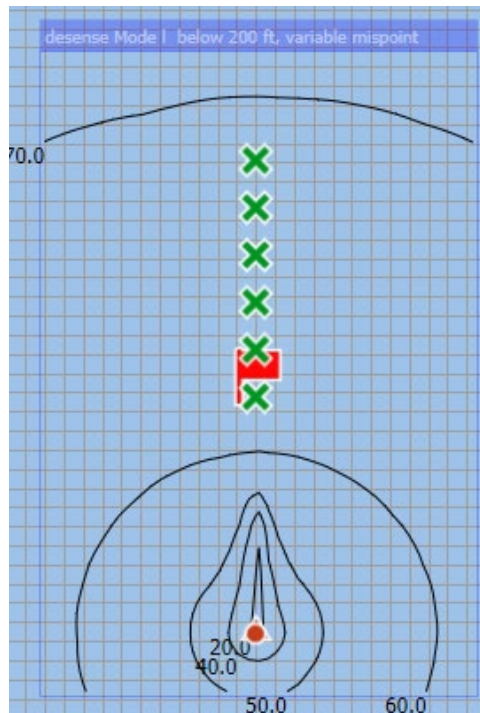

Figure 109: Margins in dB for RA model desensitisation from MFCN/WBB LMP unwanted emissions below 200 feet with fuselage loss and threshold that increases with decreasing altitude. Pitch and Roll decreases with decreasing altitude, grid = 100 m

A7.6 SENSITIVITY TO ANTENNA ASSUMPTIONS

In this section variations of the baseline cases are considered to examine the potential outcomes resulting from mixing set 2 parameters with set 1 antennas and vice versa.

It would appear that the antenna assumptions are the key element in this modelling and the variations in RA ITTs are a less significant second order consideration.

The analysis is based on simulations of the RA below 200 feet. In all cases the following variants have been examined.

Blocking from MFCN assuming Set 1 parameters for RA Model F but an omni directional antenna and no 3 dB cable loss

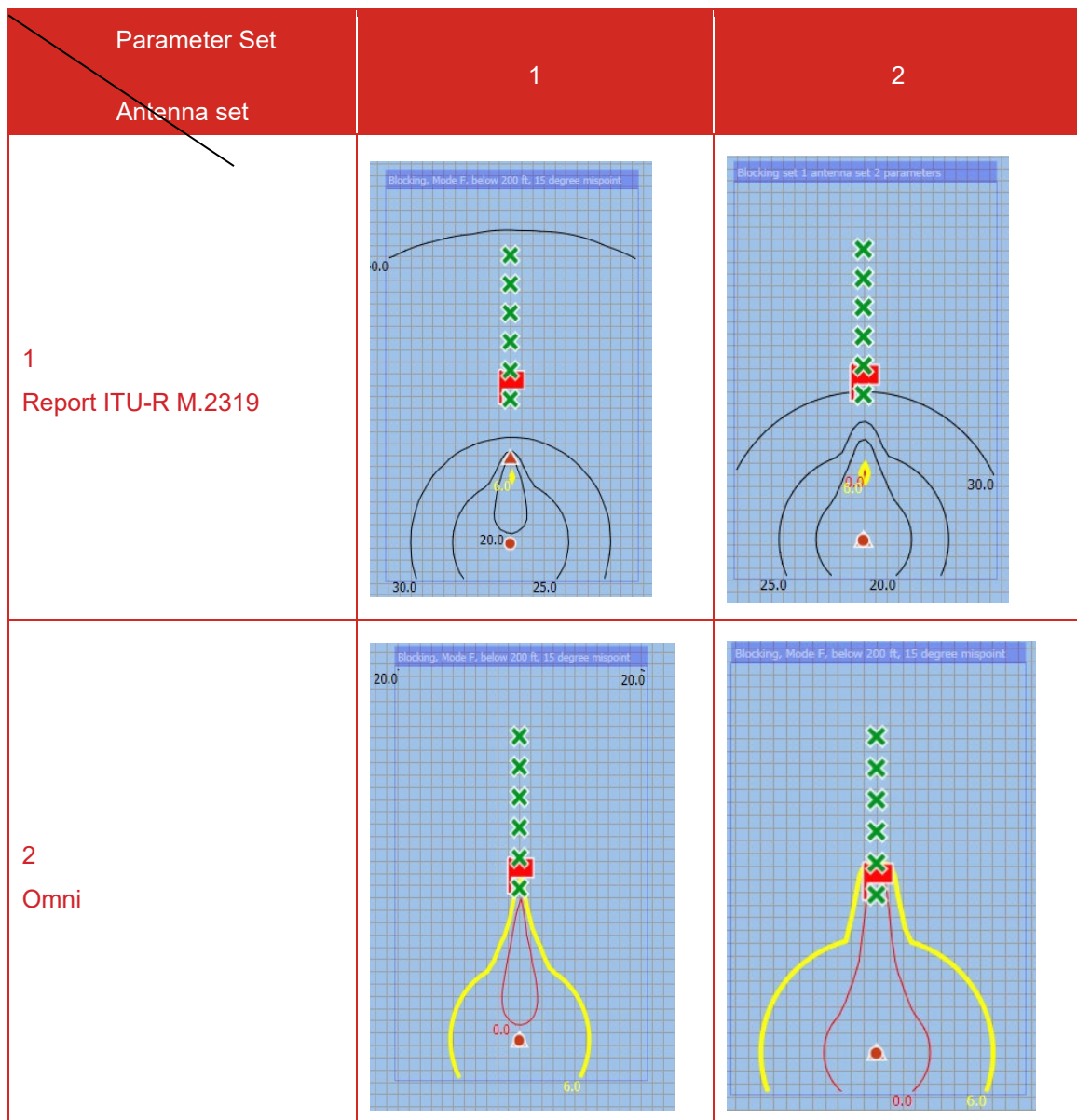

Figure 110: Impact of RA antenna assumptions. Top Left is Set 1 Antenna with Set 1 Parameters, Top Right is Set 1 antenna with Set 2 Parameters, Bottom Left is Set 2 Omni Antenna with Set 1 Parameters, Bottom Right is Set 2 antenna with Set 2 parameters, grid = 100 m

If it was possible to quantify the reflection coefficient between the 200 feet point and the runway, the contours of the figures above would all be expected take on a more circular appearance around the 200 feet point.

For completion, below is what Set 2 parameters with Set 2 antenna would look like if the changes in the physical attributes from 200 feet to touchdown are ignored.

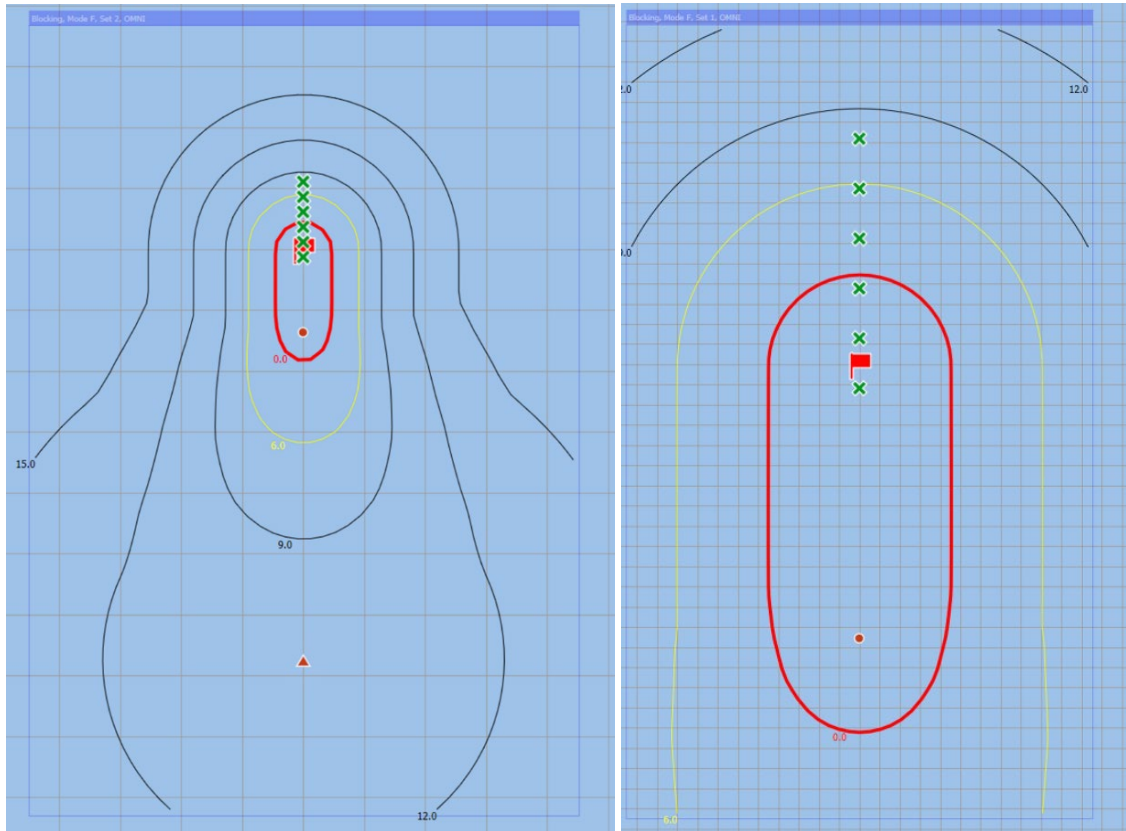

Figure 111: Grid - 1 km left, 100 m right, Blocking, RA type F, Parameter Set 2 with Set 2 omni antenna

A7.7 OBSERVATIONS

Interference is not observed in any baseline cases for parameters Set 1 at either 200 feet or 1000 feet, large margins above the defined thresholds in all cases for MFCN and WBB LMP may be seen.

When using interpolation of the ITTs in the space between 1000 feet and 200 feet only positive margins are observed.

Depending on modelling assumptions lower margins (even negative margins) in some cases below 200 feet might be seen. However, threshold values are expected to increase below 200 feet. If we assume an improvement interpolated between 200 feet and 20 feet up to 20 dB (based on increased Radio Altimeter wanted signal levels), there are no negative margins observed.

The final sensitivity analysis shows that interference levels are much higher when the Set 2 antenna assumptions (omnidirectional) are used – this conclusion is independent of the other ITT parameters used. So the one key element to further study is the Radio Altimeter antenna performance specifically in the out of band domain to determine the most realistic model to adopt in the future. **A recommendation for the aeronautical community could be to provide ITT values and to determine more thoroughly the RA antenna pattern also for the out-of-band characteristics.**

ANNEX 8: (STUDY G) COMPATIBILITY STUDY BETWEEN MFCN OPERATING IN 3.4-3.8 GHZ AND RADIO ALTIMETER OPERATING IN 4.2-4.4 GHZ USING PARAMETER SET 1

A8.1 BACKGROUND

This study is on the compatibility between MFCN operating in 3400-3800 MHz and Radio Altimeters (RA) operating in 4200-4400 MHz. The baseline study is considered to be pessimistic (near worst-case) where the base station is oriented in azimuth towards the aircraft and not taking account of the time-varying AAS beamforming characteristics. If the temporal aspect is being considered, the risk of interference to Radio Altimeter could significantly be reduced. The study uses the Parameter Set 1 for the Radio Altimeter which includes the break points of the individual Radio Altimeter models and the antenna pattern described in ITU-R recommendation.

A8.2 INTERFERENCE TOLERANCE THRESHOLD (ITT)

The Interference Tolerance Threshold (ITT) of the Radio Altimeter is used to evaluate the interference level from MFCN base station to the Radio Altimeter. The ITT is calculated from the breakpoint level of the different Radio Altimeter model at different frequency ranges and height.

A8.2.1 Radio Altimeter Breakpoints and Maximum Interference Levels

Table 82: UC 1 breakpoints between 3.4-3.8 GHz at 200 feet AGL in dBm/MHz

Altimeter model	3.4-3.7 GHz	3.7-3.8 GHz	Source
F	-21 (3.4 GHz Worst case sample)	-30 (3.8 GHz Worst case sample)	AVSI Report Vol 3 Figure 9-9
L	NB (> 0) (For 3700 MHz Percentile Criterion >2% Error)	NB (> 0) (For 3750 MHz Percentile Criterion >2% Error)	AVSI Report Vol 3 Table 8-8
T	NB (> -21.2) (For 3650 MHz Percentile Criterion >2% Error)	NB (> -21.0) (For 3750 MHz Percentile Criterion >2% Error)	AVSI Report Vol 3 Table 6-6
X	NB (> -20) (For 3650 MHz Percentile Criterion >2% Error)	NB (> -20) (For 3750 MHz Percentile Criterion >2% Error)	AVSI Report Vol 3 Table 8-10
U	NB (> -21.2) (For 3650 MHz NCD Criterion)	NB (> -21.0) (For 3750 MHz NCD Criterion)	AVSI Report Vol 3 Table 6-9
Y	NDA	-29 (For 3750 MHz)	AVSI Report Vol 1 Table 3-1

Altimeter model	3.4-3.7 GHz	3.7-3.8 GHz	Source
<p>Note: NB (> VALUE) refers to "No Breakpoint", meaning normal RA operation up to the maximum 5G signal level tested, where VALUE is the maximum power tested, and the breakpoint would be higher than this level. This tested power level should not be considered as a breakpoint.</p> <p>Note: The breakpoints are converted to dBm/MHz</p> <p>Note: NCD refers to "no computed data"</p> <p>Note: NDA refers to "no data available," meaning testing was not conducted for the frequency range.</p> <p>Note: Model L was not tested below 3.6 GHz. For this model it is assumed that the breakpoint power is equivalent for frequency bands farther from the 4.2 GHz band edge in the case that no data is available</p> <p>Note: For Model X, breakpoints are measured at AGL = 250 feet in AVSI Report Vol 3.</p> <p>Note: The breakpoints consider a percentile criterion of +/-2% error and an NCD criterion and do not consider a criterion of a mean error of 0.5%. The mean error deviation of 0.5% is more stringent than the Radio Altimeter height accuracy of +/-3%, across 95% of measured observations that is defined in RTCA DO-155 / EUROCAE ED-30 [20].</p>			

The interference tolerance threshold (ITT)

The provided breakpoints can be converted to an interference tolerance threshold (ITT) using Equation 1.

$$ITT = BP - BTI_f - EE_f - U\&T_f$$

Where:

- *ITT*: The interference tolerance threshold at the input to the Radio Altimeter Transceiver Receive Port. The interference tolerance threshold is defined for a specific altitude and frequency offset as the highest power for which performance is still acceptable (dBm/MHz);
- *BP*: The breakpoint of the altimeter (dBm/MHz);
- *BTI_f*: A *BP*-to-*ITT* backoff factor that accounts for the step-size used in the AVSI testing. (dB);
- *EE_f*: An experimental error factor (dB);
- *U&T_f*: A unit-to-unit and temperature interference tolerance performance variation factor (dB).

The ITT and breakpoints are derived considering an MFCN channel bandwidth of 80 MHz in the 3.4-3.8 GHz frequency range.

The necessary constants to convert the RA Breakpoints to Interference Tolerance Thresholds are provided in Table 83 and the breakpoint for each of the altimeter model is in Table 82.

Table 83: Constants for Equation 1 for Specified Altimeter Models

Parameter	Unit	Value
<i>BTI_f</i>	dB	1
<i>EE_f</i>	dB	1
<i>U&T_f</i>	dB	0 (for Altimeter model F, L and X) 4 (for Altimeter model T, U, and Y)

For altimeter model F, U&T_f is chosen to be 0 dB as the value taken from AVSI Report Volume 3 is the worst-case sample which in our view takes account of this variation factor. The rest of the parameters in this table was agreed in ECC.

The resulting interference tolerance thresholds (ITT) for 200 feet are shown in Table 84.

Table 84: Interference tolerance thresholds (ITT) for 200 feet in dBm/MHz

Frequency range (GHz)	Radio Altimeter Model					
	F	L	T	X	U	Y
3.4-3.7	-23	-	-	-	-	-
3.7-3.8	-32	-	-	-	-	-35
4.2-4.4	-69	-77	-66.8	-59.8	-	-70

A8.3 PARAMETERS USED IN THE STUDY

The study uses parameters in section 4.3 and this section highlights some of these which includes additional ones.

A8.3.1 Radio Altimeter

The relevant Radio Altimeter antenna characteristics are shown in Table 85.

Table 85: Radio Altimeter antenna gain

Frequency range	Peak gain and 3 dB BW	Cable loss	Pattern
3.4-4.1 GHz	0 dBi, 60° 3 dB-BW	3 dB	Report ITU-R M.2319 (Equation A-3.6)
4.2-4.4 GHz	9 dBi, 60° 3 dB-BW	3 dB	

Table 85 illustrates the Radio Altimeter antenna gain at different frequencies. The study evaluates two frequency ranges, 3.4-4.1 GHz (for the blocking) and 4.2-4.4 GHz (for the unwanted emissions domain).

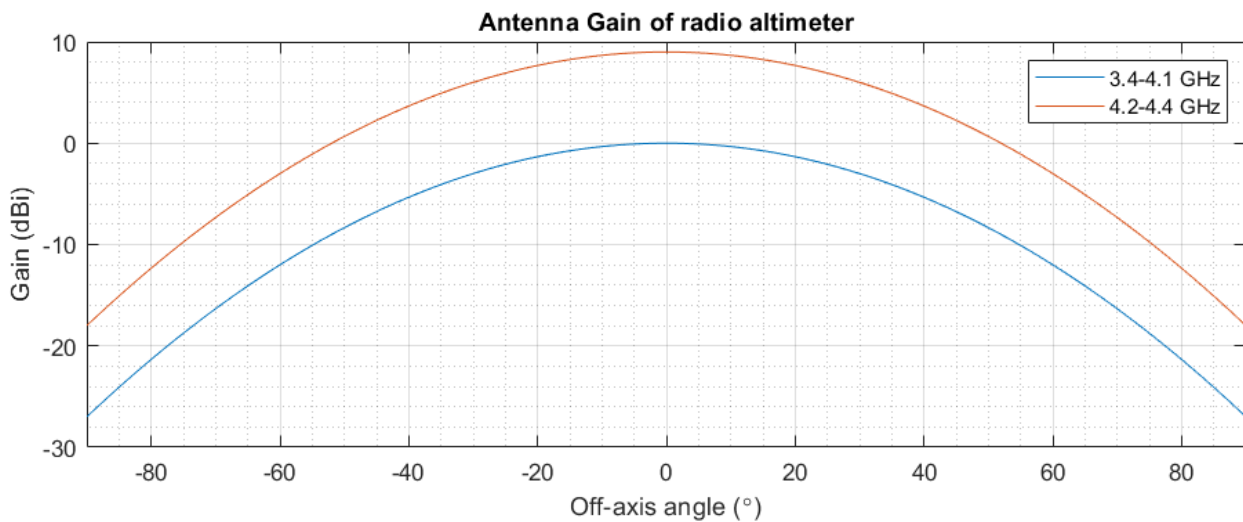

Figure 112: Radio Altimeter antenna gain

Figure 112 is a 3-dimensional plot of the Radio Altimeter antenna gain at 4.2-4.4 GHz, illustrating that the antenna gain pattern is a function of the off-axis angle from the boresight of the antenna.

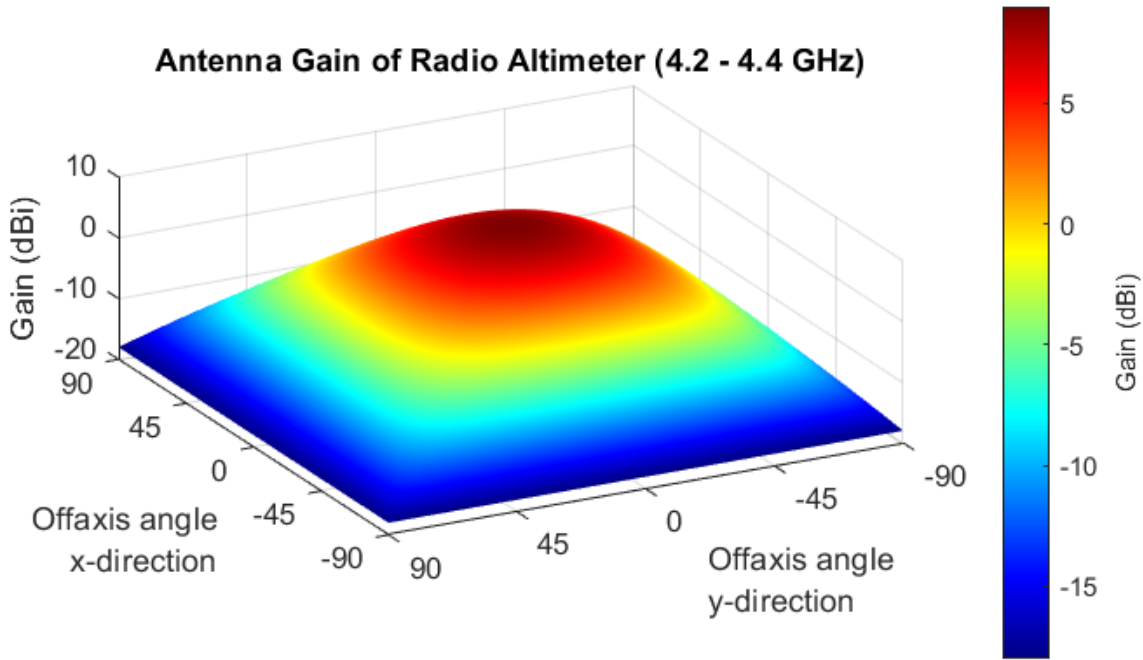

Figure 113: 3D Radio Altimeter antenna gain

A8.3.2 MFCN 3.4-3.8 GHz

The MFCN base station configuration used in this study is the AAS urban macro as described in the parameters table in Annex 1 with a maximum output power/sector (*e.i.r.p.*) of 78 dBm/100 MHz.

The study looks at the worst emission configuration from the MFCN parameters used and the highest emission comes from the horizontal boresight direction. Although the vertical coverage range is defined as 90°-100°, the actual cell range will define the minimum electrical tilt for the AAS as illustrated in Figure 114.

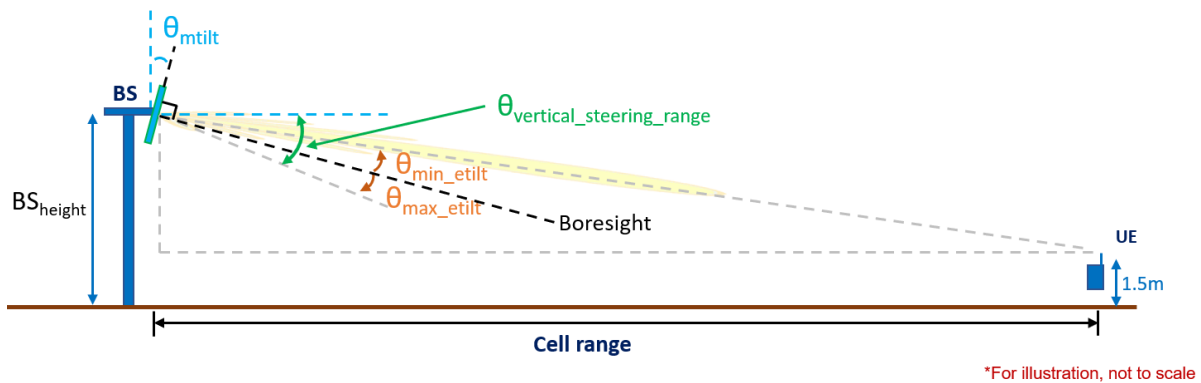

Figure 114: Relation between cell range and the minimum electrical tilt (vertical)

Therefore, for a cell range of 400 m and a mechanical downtilt of 6°, the minimum electrical tilt, θ_{\min_etilt} , will be -3.4° and with a maximum electrical tilt, θ_{\max_etilt} , of 4°, and the envelope of the MFCN base station is shown in Figure 115.

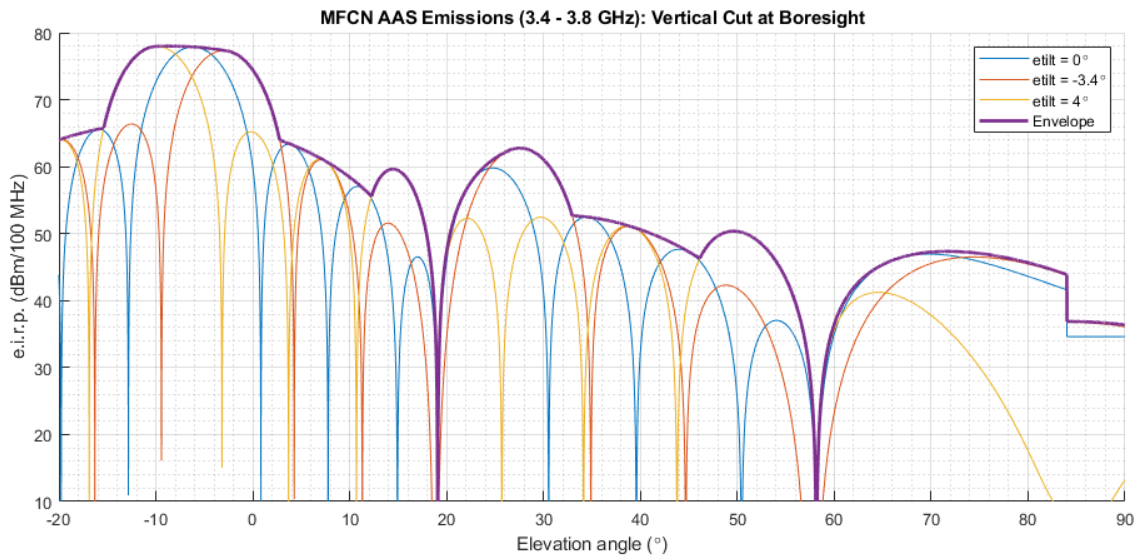

Figure 115: MFCN AAS emissions

A8.3.3 The unwanted emissions domain for MFCN AAS Base Station

The spurious emissions domain for the base station for this frequency band starts at 40 MHz from the band edge (i.e. 4200 MHz) and the -30 dBm/MHz TRP limit is defined in the current ERC Recommendation 74-01 for AAS. Since the Radio Altimeter is operating more than 200 MHz away, the fully uncorrelated AAS antenna pattern (single-element pattern) is used.

A8.3.4 Propagation Loss

The path loss is calculated at 3.55 GHz and 3.75 GHz to investigate the blocking level, and at 4.25 GHz for the unwanted emissions domain. Since the propagation is from the base station to the Radio Altimeter, only free-space path loss is considered without any clutter. Figure 116 shows the free-space path loss at these frequencies.

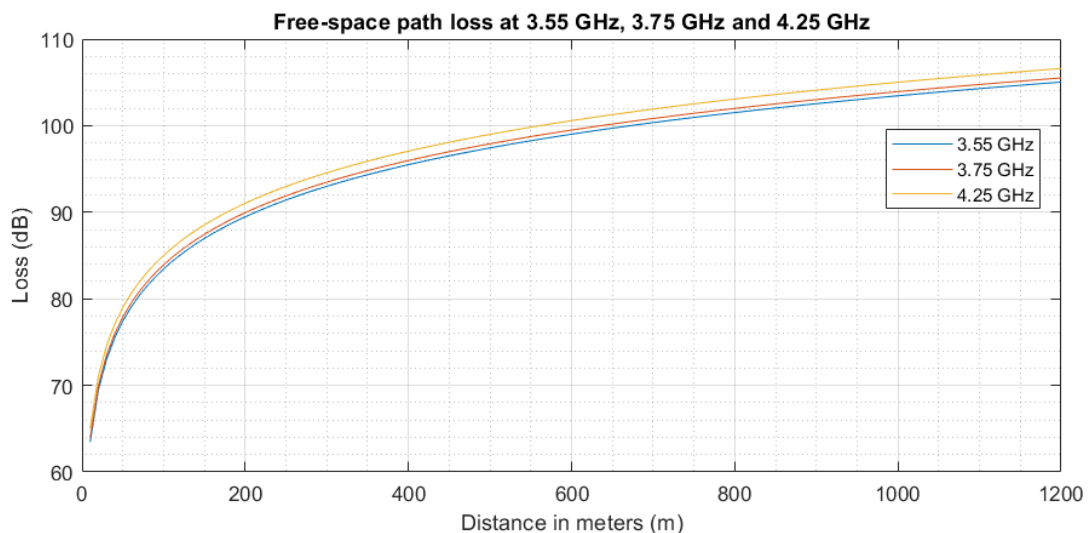

Figure 116: Path loss

In addition to the free-space path loss, a 1.5 dB polarisation loss is included as the interference analysis is based on main-beam to main-beam (utilising information from previous studies¹⁸ involving dual-polarised IMT with other services).

A8.4 INTERFERENCE SCENARIO

The interference scenario in this contribution is based on the agreed landing scenario with the obstacle limitation surface (OLS) defined around airports (aerodrome). The interference from MFCN to Radio Altimeter can only be assessed based on the 200 feet and 1000 feet points where the breakpoints of the Radio Altimeter are provided. Assessing interference margins against interpolated/extrapolated ITT at other heights are not agreed in CEPT and it is deemed to be speculative by the proponent of this study.

A8.4.1 The Baseline Scenario

The interference scenario is shown in Figure 117 with a glide slope of 3° to the touchdown point¹⁹.

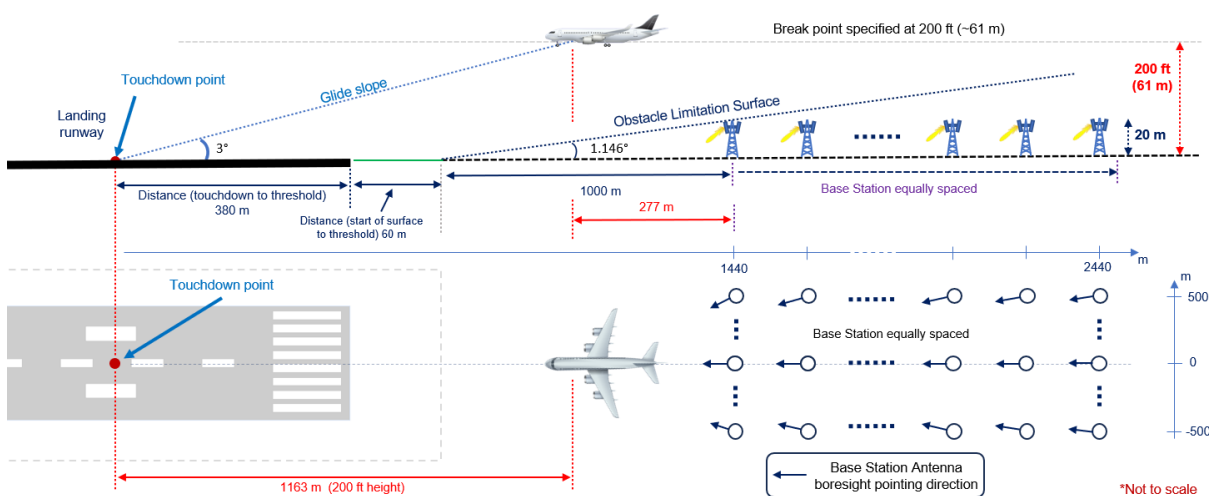

Figure 117: Interference scenario

The MFCN base stations are at the height of the 20 m, and they are set directly under the flight path at regular distance intervals from the start of the Obstacle Limitation Surface point on the ground. The first base station is 1000 m from the start of this point to satisfy the height restriction set by the recommended OLS. The closest base station to the aircraft at 200 feet would be around 277 m (ground distance). The study also evaluates emissions from the MFCN base station lateral to the flight path as shown in Figure 117. It is worth highlighting that it is sufficient to consider the emissions from only a single MFCN base station set in a worst-case scenario (dominant interferer). Hence, this scenario is representative enough to cover the aggregation case involving multiple MFCN base station.

A8.4.2 Orientation of the MFCN Base Station - Boresight

The base station antenna gain is at its highest (for a particular elevation angle) in the horizontal boresight direction of the MFCN antenna panel, and this gain is used to evaluate the worst-case emissions from the MFCN base station to the Radio Altimeter. Figure 118 is an illustration of the angular relationship (azimuth) between the MFCN base station antenna panel and the Radio Altimeter (represented by the 'Point').

¹⁸ Polarisation loss has been extensively discussed and the conclusions have been embedded in <https://www.itu.int/md/R15-TG5.1-C-0478/en>.

¹⁹ The aircraft glide slope angle used by the Instrument Landing System (ILS) is usually 3°.

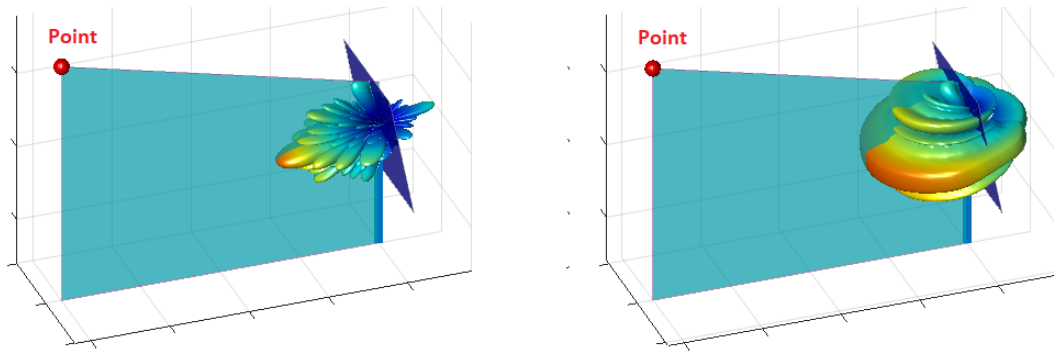

Figure 118: Boresight plane (perpendicular to antenna panel) – (a) antenna gain of an AAS base station, (b) antenna gain envelope of the AAS base station

A8.5 SIMULATION RESULTS

The Interference Tolerance Threshold (ITT) in Table 84 is compared against the MFCN base station power level at the Radio Altimeter (as shown in Equation 1Equation 31):

$$I_{MFCN} = MFCN_{emission} - PL + Gain_{RA} - RA_{cable}$$

Equation 31

Where:

- I_{MFCN} : the MFCN interference power at the Radio Altimeter where it's compared to ITT
- $MFCN_{emission}$: the MFCN base station emissions
- PL: the propagation loss which encompasses the path loss and polarisation loss
- $Gain_{RA}$: the antenna gain of the Radio Altimeter
- RA_{cable} : the cable loss from the Radio Altimeter side

A8.5.1 MFCN Interference (In-band)

The MFCN base station interference power from the in-band 3.4-3.7 GHz at the Radio Altimeter antenna (taking account of the antenna gain and the cable loss) is show in Figure 119 and Figure 120.

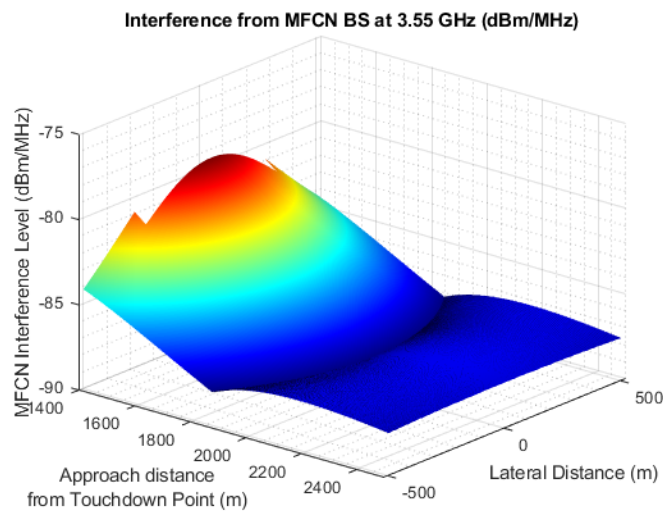

Figure 119: MFCN base station interference at the Radio Altimeter antenna (3.55 GHz)

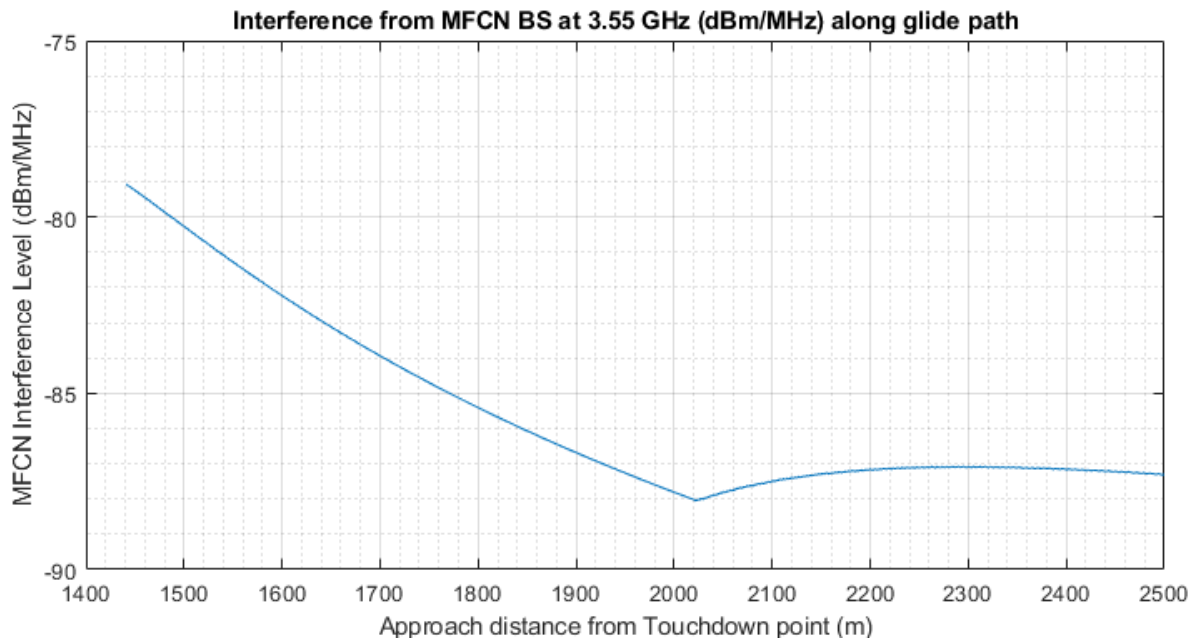

Figure 120: Interference from MFCN at the 200 feet altitude along glide path (3.55 GHz)

The MFCN base station interference from the in-band 3.7-3.8 GHz at the Radio Altimeter antenna (taking account of the antenna gain and cable loss) is show in Figure 122 and Figure 123.

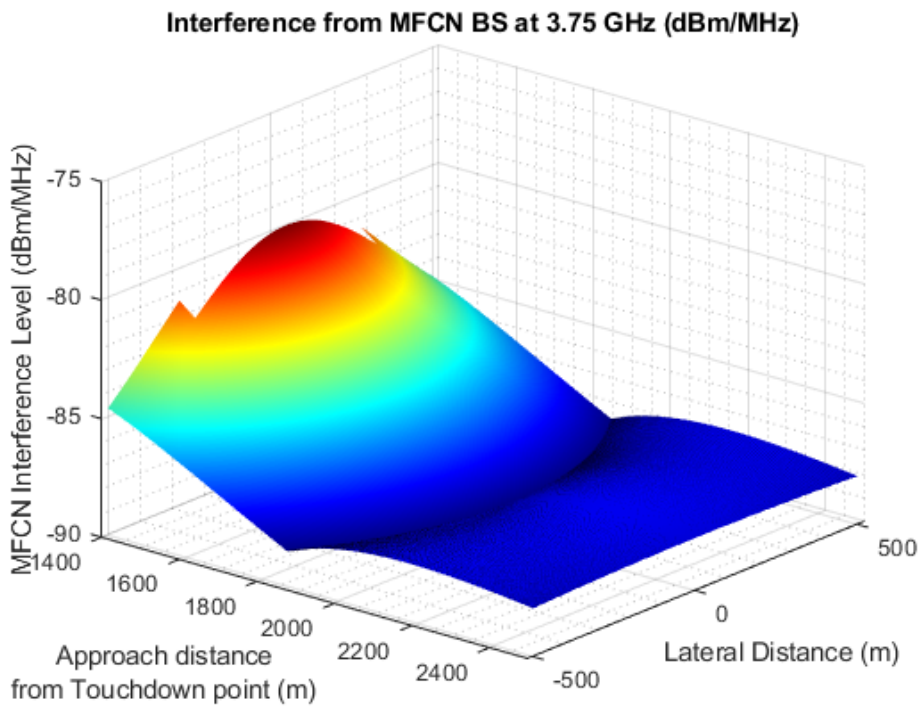

Figure 121: MFCN base station interference at the Radio Altimeter antenna (3.75 GHz)

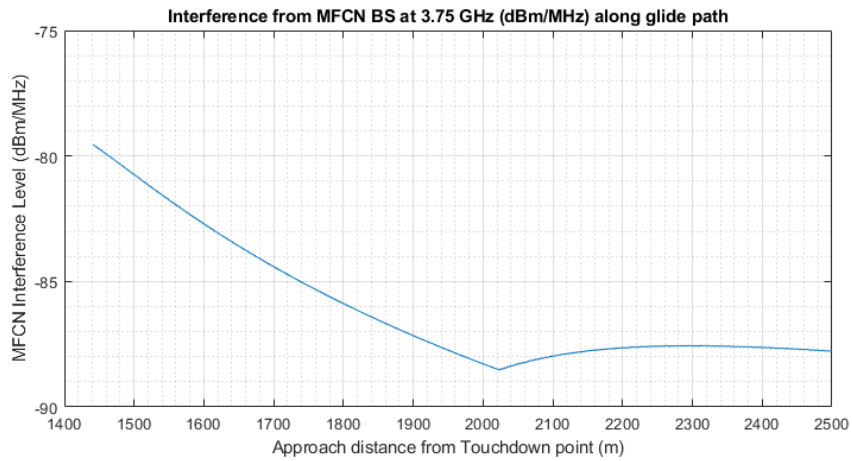

Figure 122: Interference from MFCN at the Radio Altimeter antenna along glide path (3.75 GHz)

A8.5.2 MFCN Interference (unwanted emissions)

The MFCN base station interference power from the unwanted emissions domain, i.e. 4.2-4.4 GHz, at the Radio Altimeter antenna (taking account of the antenna gain and the cable loss) is shown in Figure 124 and Figure 125.

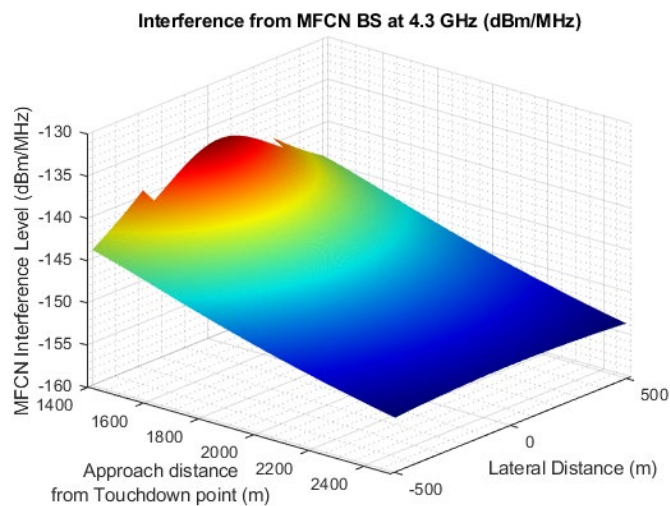

Figure 123: MFCN base station interference from the unwanted emissions domain at the Radio Altimeter antenna (4.3 GHz)

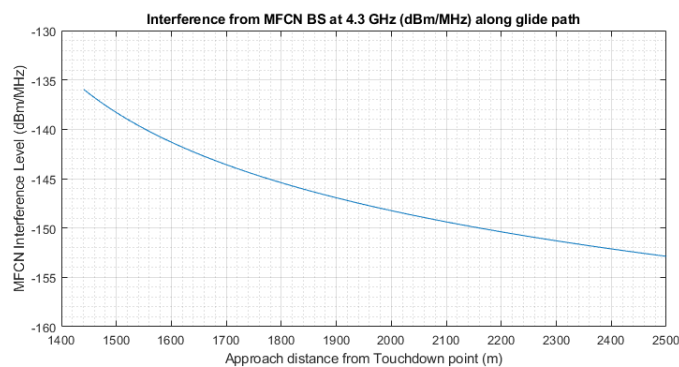

Figure 124: Interference from MFCN in the unwanted emissions domain at the Radio Altimeter antenna along glide path (4.3 GHz)

A8.5.3 Comparison to The Interference Tolerance Threshold

The ITT levels for the various Radio Altimeter models can be found in Table 84, and the margin against the MFCN emissions for the 3.4-3.7 GHz and 3.7-3.8 GHz range can be seen in **Error! Reference source not found.** and **Error! Reference source not found.** respectively. This margin is more than 45 dB for the worst altimeter model for both frequency ranges.

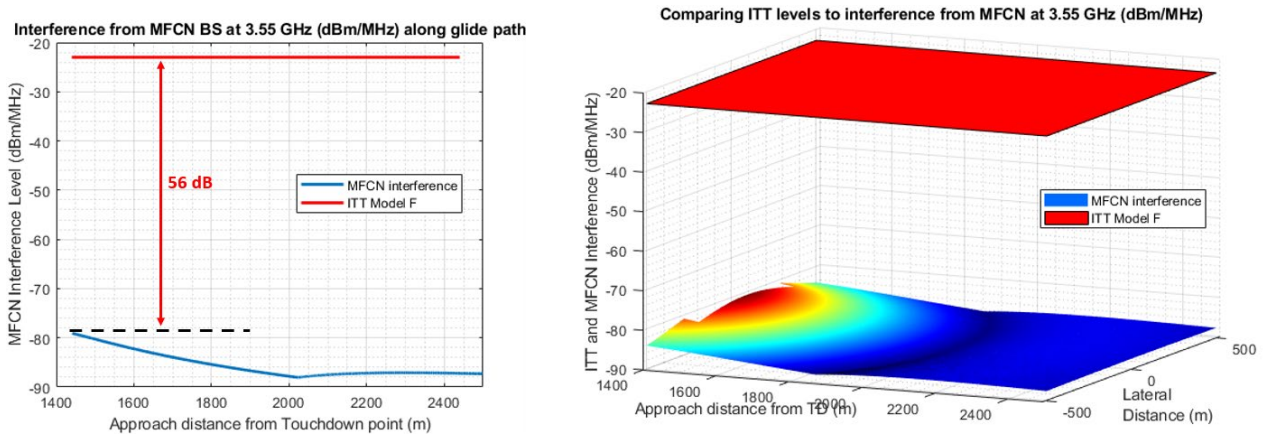

Figure 125: Comparing the ITT levels with the MFCN emissions at 3.55 GHz

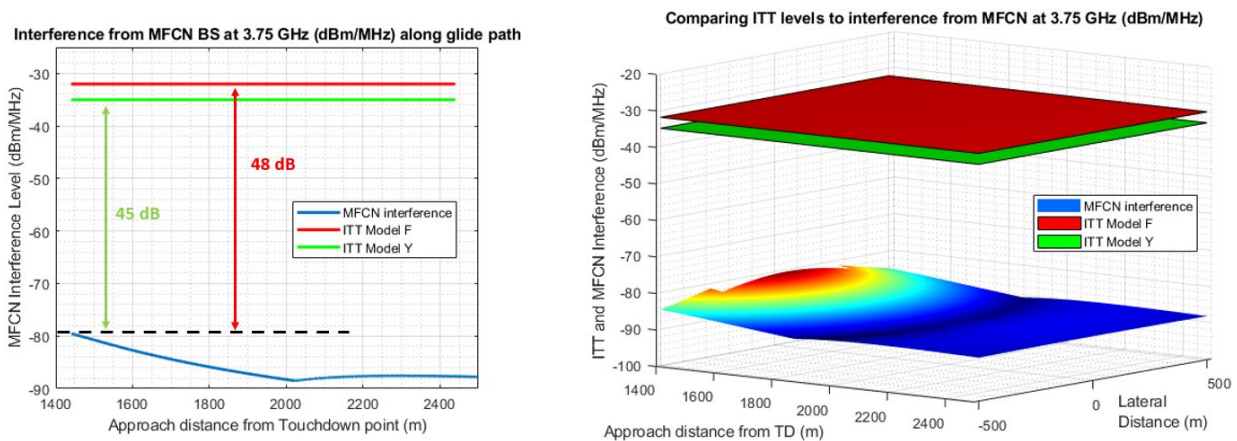

Figure 126: Comparing the ITT levels with the MFCN emissions at 3.75 GHz

For the MFCN base station unwanted emissions domain (i.e. 4.2-4.4 GHz), the margin is in excess of 15 as shown in Figure 127 **Error! Reference source not found.**

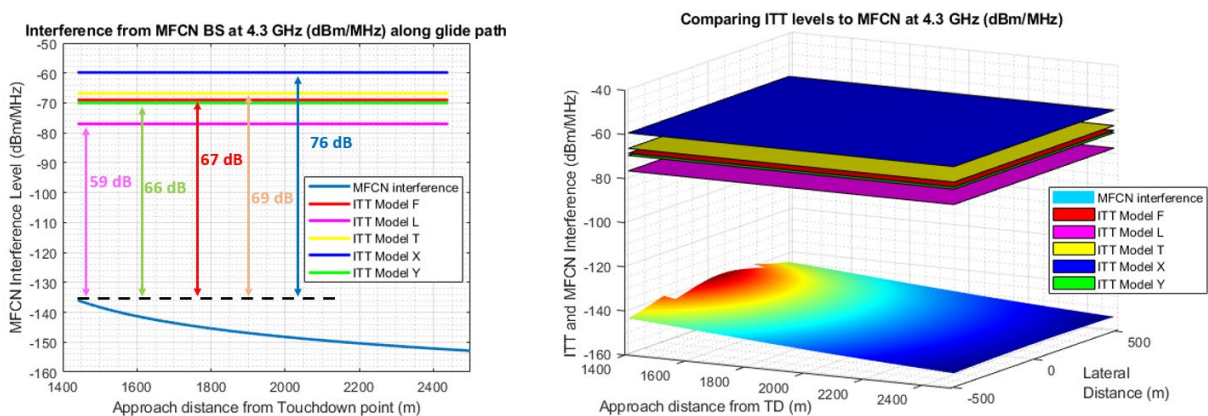

Figure 127: Comparing the ITT levels with the MFCN in the unwanted emissions at 4.3 GHz

The margin to the ITT for the different Radio Altimeter models at 200 feet for the different frequency ranges is summarised in Table 86. **Error! Reference source not found.**

Table 86: Margin to the interference tolerance thresholds (ITT) at 200 feet in dB

Frequency range (GHz)	Radio Altimeter Model					
	F	L	T	X	U	Y
3.4-3.7	56	NA	NA	NA	NA	NA
3.7-3.8	48	NA	NA	NA	NA	45
4.2-4.4	67	59	69	76	NA	66

Note: NA in the table is due to the lack of information or no breakpoints from the Radio Altimeter models in those frequencies.

A8.5.4 Suburban and Rural Environment

The study also looked at the MFCN interference for the suburban and rural environment. The various parameters such as the base station antenna height, mechanical downtilt, cell radius, etc. were adjusted accordingly.

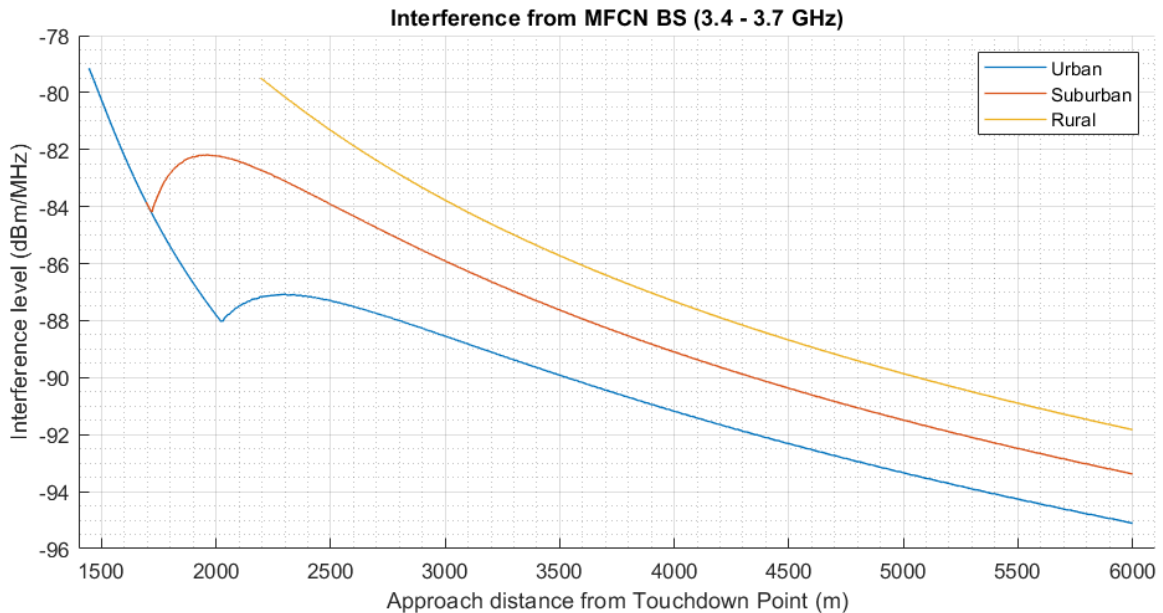

Figure 128: Interference from MFCN base station in different deployment environment

The base station nearest to the touchdown point will be different for the different deployment environment (i.e. suburban and rural) due to the OLS, therefore, the interference curve in **Error! Reference source not found.** starts at different distances from the touchdown point.

Looking at **Error! Reference source not found.**, the urban environment presents the most limiting case, therefore, the overall conclusion on the interference to Radio Altimeter doesn't change, and the margin to the ITT in Table 86 now represents the lowest margin regardless of which MFCN deployment environment.

A8.5.5 Interference to aircraft at 1000 feet

When the aircraft is at 1000 feet, the interference from MFCN base station follows a different pattern as shown in **Error! Reference source not found.** The location of the aircraft is around 5816 m (ground distance along the glide path) away from the touchdown point and the maximum interference from MFCN occurs when the

aircraft (Radio Altimeter) is almost directly above the MFCN base station with a maximum interference level of -71 dBm/MHz.

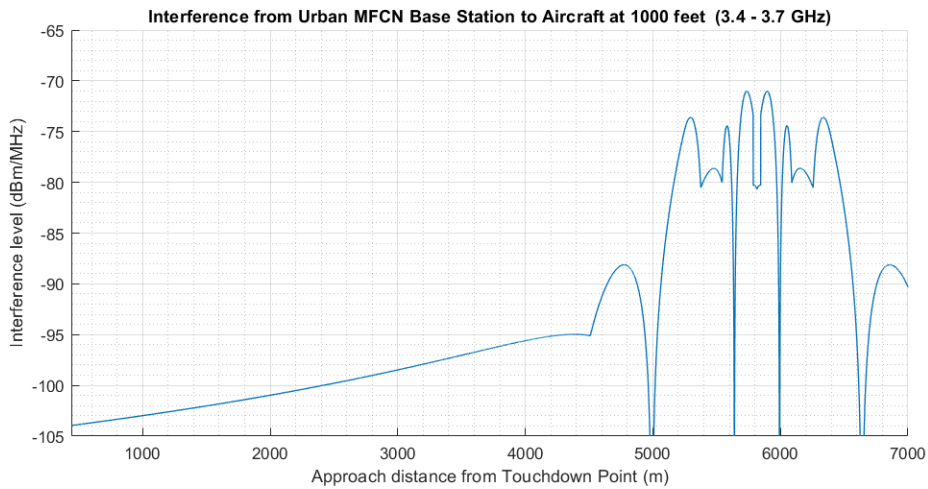

Figure 129: Interference from urban MFCN base station to aircraft at 1000 feet

Even when the interference from MFCN base station is at its highest, it offers significant margin to the ITT level of all Radio Altimeter models (where data is available).

A8.6 PARAMETRIC ANALYSIS

A8.6.1 Antenna Electrical Steering

For the urban environment setup, the MFCN base station cell radius is defined as 400 m (with a 6° mechanical downtilt), and the minimum electrical steering is found to be -3.4° (i.e. 92.6° vertical angle which is within the vertical coverage range parameter). As the vertical coverage range is defined as 90°-100°, the MFCN base station can be electrically steered to a minimum of -6°, which is the same as the mechanical downtilt. Figure 130 shows the difference between the baseline and this theoretical minimum steering angle. 90° is essentially pointing the beam towards the horizon which requires the base station to be at the same height as the user equipment (UE).

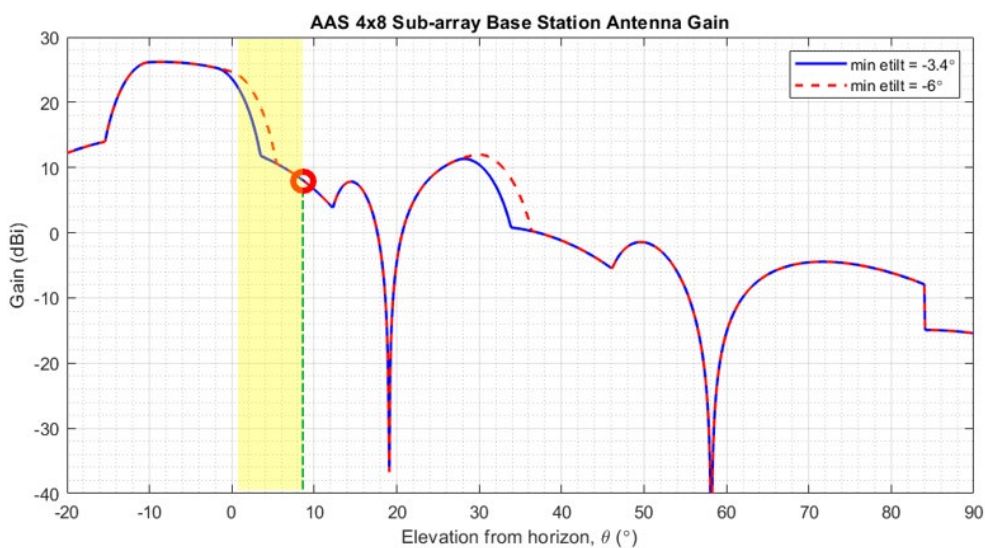

Figure 130: Antenna pattern for different minimum electrical tilt

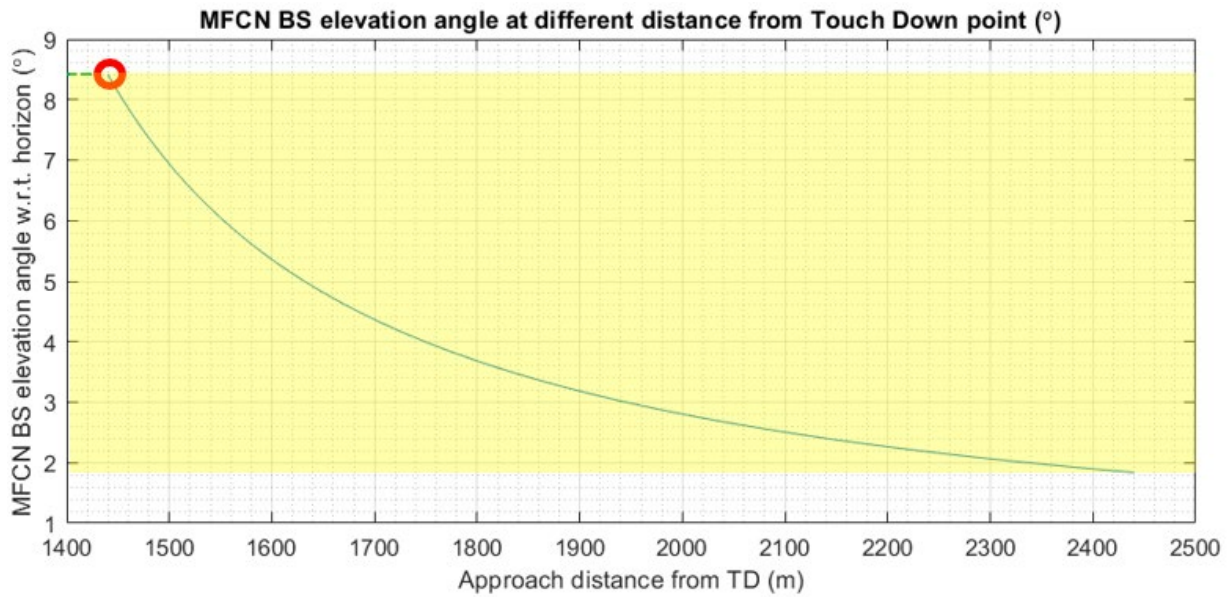

Figure 131: Antenna pattern for different minimum electrical tilt

Figure 130 shows the elevation angle from the MFCN Base Station towards the Radio Altimeter and this study indicates a range between 1.8° to 8.4° (indicated by the yellow shading). The red circle in Figure 130 and Figure 131 indicates the relationship of the elevation angle to the MFCN antenna gain, and it shows that changing the electrical steering angle from -3.4° to -6° has no material impact to the interference from the MFCN Base Station.

A8.6.2 Altimeter antenna gain on aircraft roll

Applying the aircraft roll will have an impact to the Radio Altimeter antenna gain evaluated for the study but the impact to the base stations along the glide path is minimal as shown in Figure 132. The Radio Altimeter antenna gain is highest along the glide path when aircraft roll is not considered, therefore, setting this baseline scenario near worst-case along the glide path.

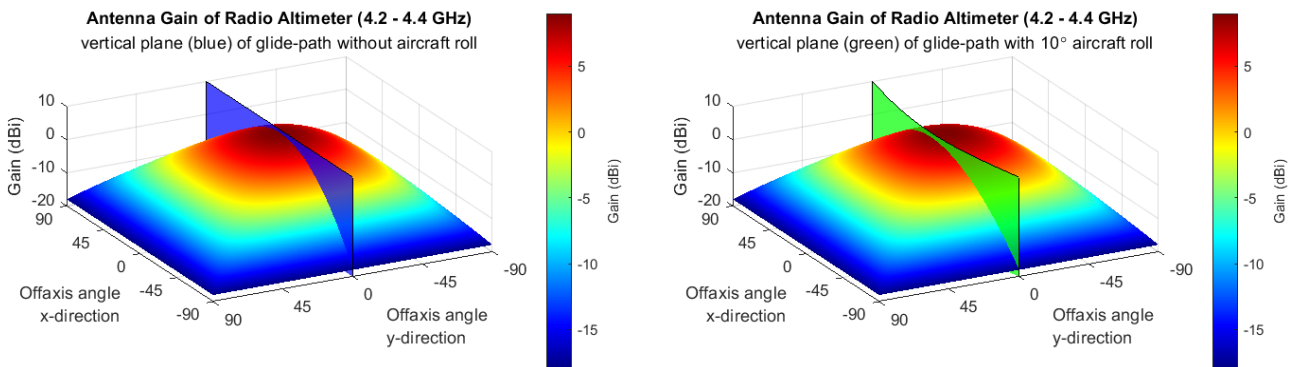

Figure 132: Impact of roll to the Radio Altimeter antenna gain

It is worth pointing out that the baseline study does not evaluate the aircraft (Radio Altimeter) at different heights (other than 200 feet) along the glide path, but if it does, this conclusion also applies.

A8.6.3 Interference level from MFCN base station violating the Obstacle Limitation Surface (OLS)

The interference scenario analysed in the earlier sections is considered to be the typical landing scenario and it is important to provides additional analyses to understand the coexistence situation when the scenario changes.

Currently the typical landing scenario studied for the urban environment is shown in Figure 134 where the height of the base station is at 20 m, meaning there will be no base station directly below the aircraft at 200 feet.

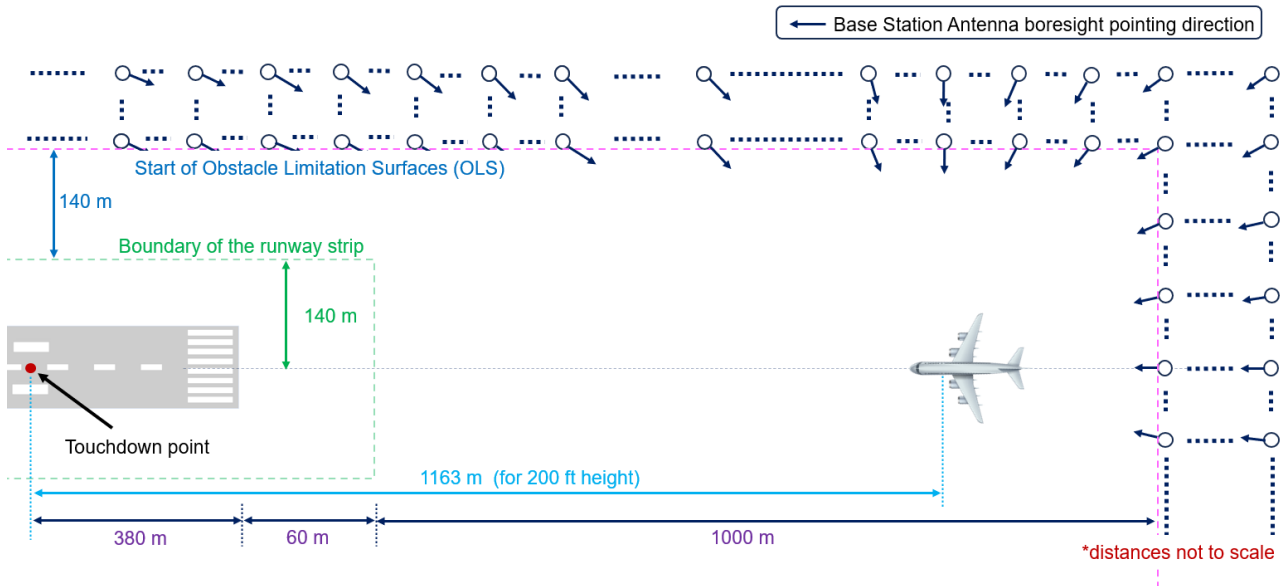

Figure 133: Interference scenario for the urban environment

As seen in the earlier analysis the interference from MFCN is increasing as the MFCN base station gets closer to OLS boundary, which also means that it is closer to the aircraft/Radio Altimeter (ground distance). Therefore, it will be informative to investigate which MFCN base station location will cause the peak interference.

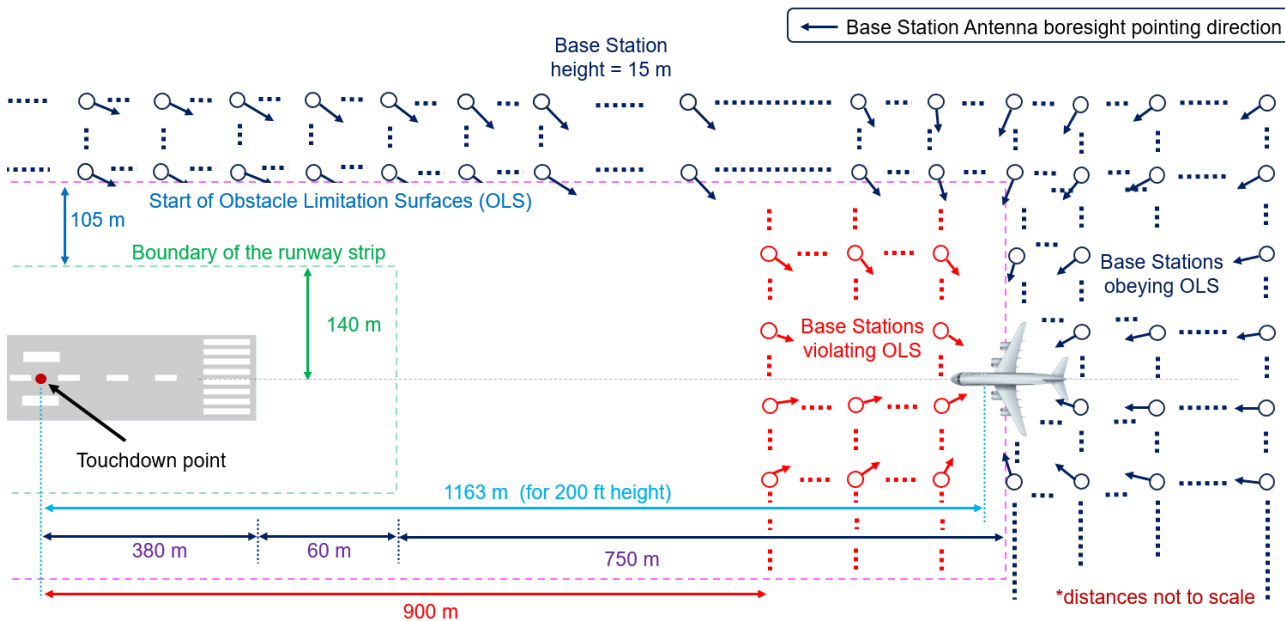

Figure 134: Interference scenario for the urban environment with BS violating the OLS

Figure 135 shows a hypothetical situation where the height of the base station is adjusted to 15 m, and some of these base stations are violating the OLS (i.e. above the OLS). The minimum distance from the touchdown point is set to 900 m (i.e. 700 m from the edge of the runway). The result is shown in Figure 136 where the solid plot is the interference level from base stations located below the OLS (i.e. obeying the OLS), whilst some of the considered base stations violating the OLS are shown as scattered points.

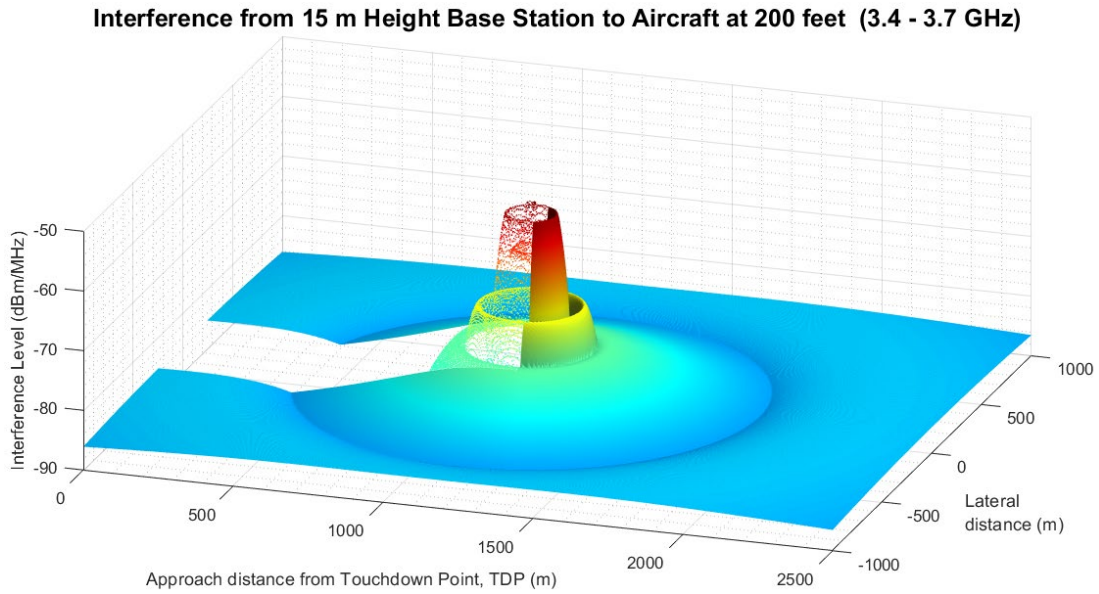

Figure 135: Interference from base station (15 m height) and above/below the OLS (3.4-3.7 GHz)

As indicated in Figure 135, the aircraft is located 200 feet (61 m) above ground and 1163 m from the touchdown point. The maximum interference to the Radio Altimeter is caused by the MFCN base stations nearly directly below the aircraft as shown in Figure 137.

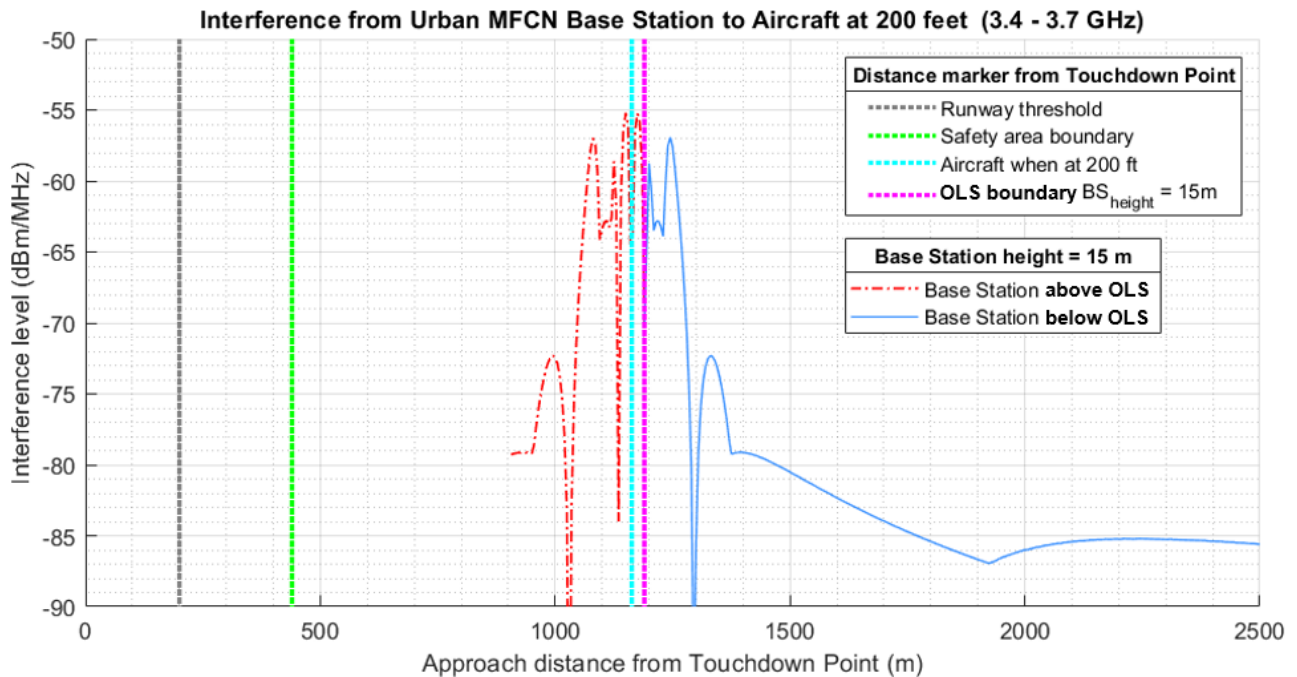

Figure 136: Interference from base station (15 m height) and above/below the OLS along the glide path (3.4-3.7 GHz)

As it can be seen, the interference level peaks at -55 dBm/MHz, and this is still significantly lower than the ITT levels of the least resilient Radio Altimeter for this frequency range (i.e. 3.4-3.7 GHz) which is -23 dBm/MHz, meaning a margin of 32 dB. As the ITT for the least resilient Radio Altimeter is 12 dB lower for the frequency range 3.7-3.8 GHz, the interference calculation was repeated for this frequency range and the result is shown in Figure 138.

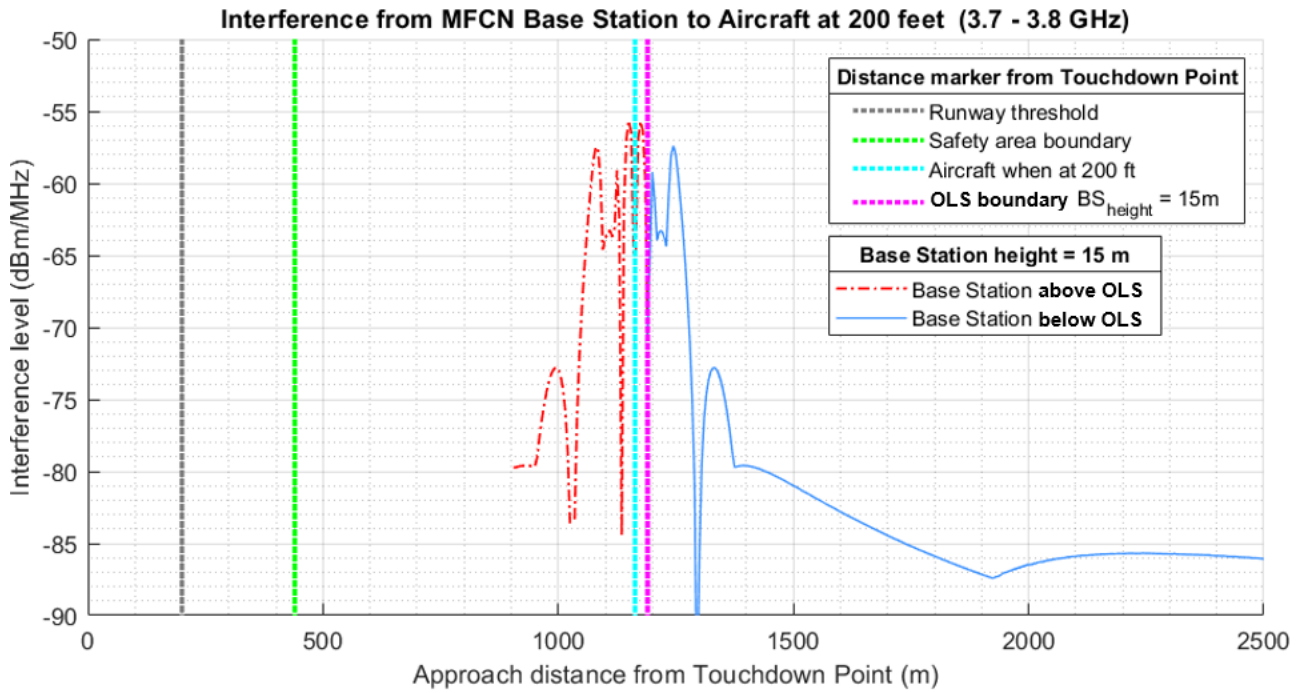

Figure 137: Interference from base station (15 m height) and above/below the OLS along the glide path (3.7-3.8 GHz)

As expected, the overall interference is slightly less due to the slight increase in free space path loss. Although the peak interference level is -56 dBm/MHz, the margin drops to 21 dB as the ITT for the least resilient Radio Altimeter model Y is -35 dBm/MHz.

A8.6.4 Glide slope

The glide slope defined in the landing scenario is 3° with a tolerance of ±0.375°. The baseline scenario considered in the study is 3° but this slope will have an influence on where the aircraft will be at 200 feet with respect to the base station as shown in Figure 138.

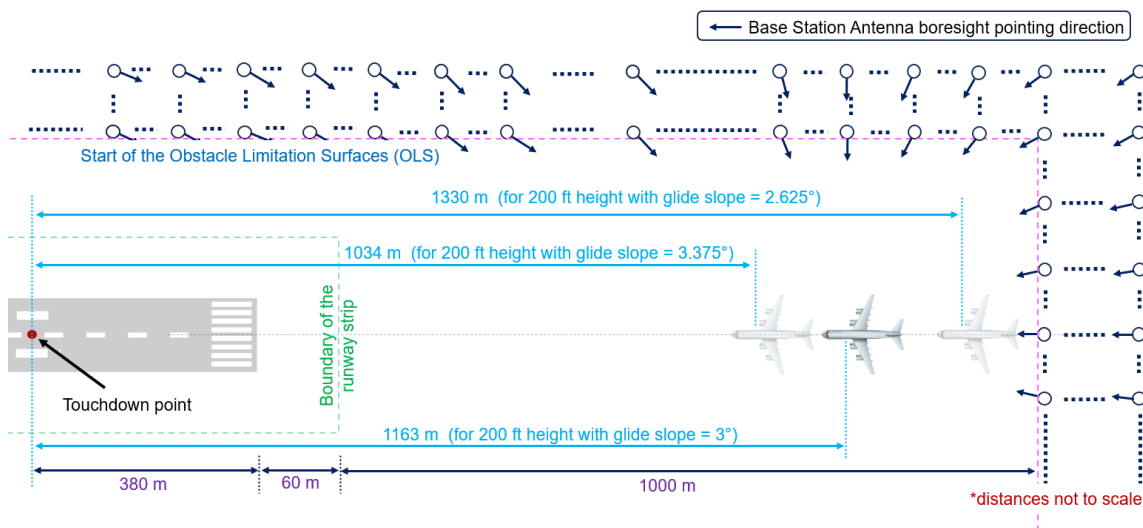

Figure 138: Location of aircraft for different glide slope

As seen in Figure 139, defining the glide slope to be 2.625° will shift the location of the aircraft (at 200 feet altitude) closer (viewing on ground distance) to the MFCN base station located at the OLS boundary. As shown in the earlier parametric analysis, the interference level will peak when the aircraft is nearly above the MFCN base station.

A8.6.5 Interference of urban MFCN base stations to aircraft at different heights

This section looks at the interference from urban MFCN base stations to the aircraft at different heights following the glide slope of 3° to the touchdown point. The heights of the aircraft are set to 61 m (200 feet), 50 m, 40 m, 30 m and 20 m, and the interference scenario is as shown in Figure 140.

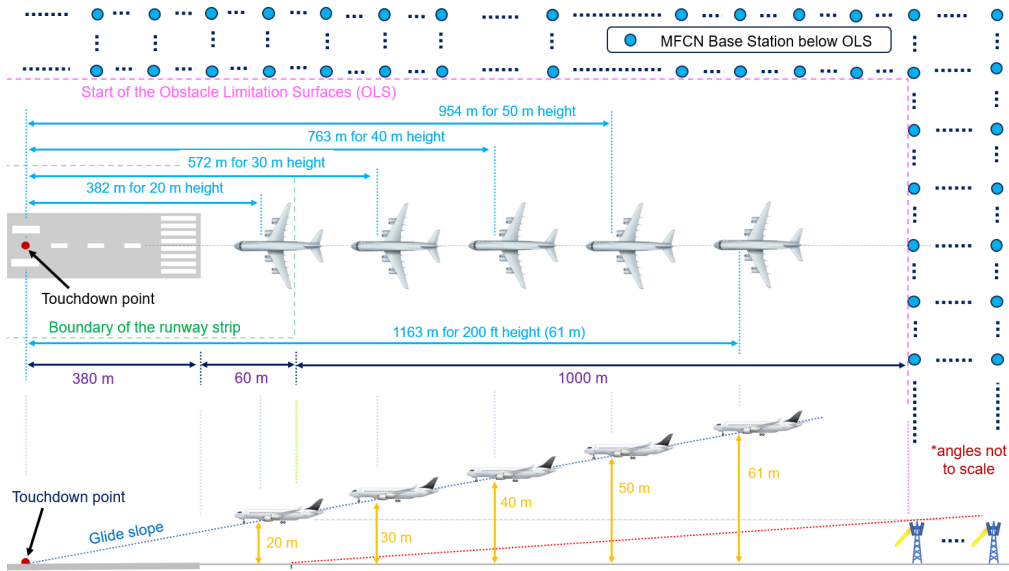

Figure 139: Location of aircraft for different height

The study does not evaluate aircraft height lower than the MFCN base station height (of 20 m) because there are further attenuation from the aircraft fuselage and the interference from the base station can be considered negligible.

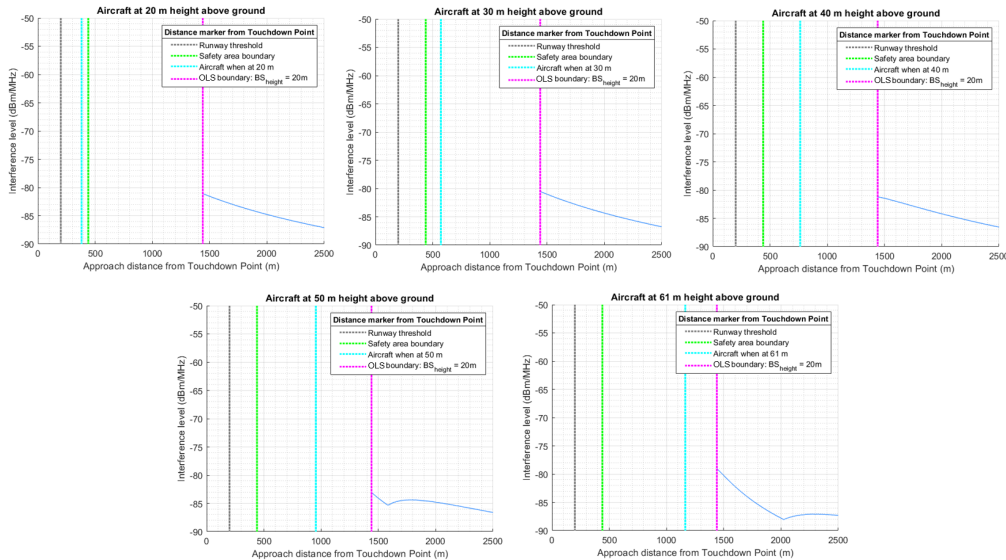

Figure 140: Interference from urban MFCN base station at different aircraft height

The maximum interference level ranges from -81 dBm/MHz to -79 dBm/MHz indicating that there is significant margin to the ITT on a typical landing scenario as the aircraft lands.

A8.6.6 Combining several worst-case parametric settings

This section looks at the combining the parameters settings that are outlined earlier to assess the overall impact to the MFCN interference towards the Radio Altimeter. This includes setting the base station height to 15 m with a glide slope of 2.625° and using the MFCN base station (urban) with a hypothetical electrical steering of the beam towards horizon (i.e. vertical coverage angle 90°). The frequency range 3.7-3.8 GHz is used because the ITT level for this frequency range is more critical to interference. This scenario also looks at the interference to the aircraft (Radio Altimeter) at different heights above ground following the glide path – assessing the interference to the aircraft as it lands from 200 feet to ground (in snapshots) (see Figure 142).

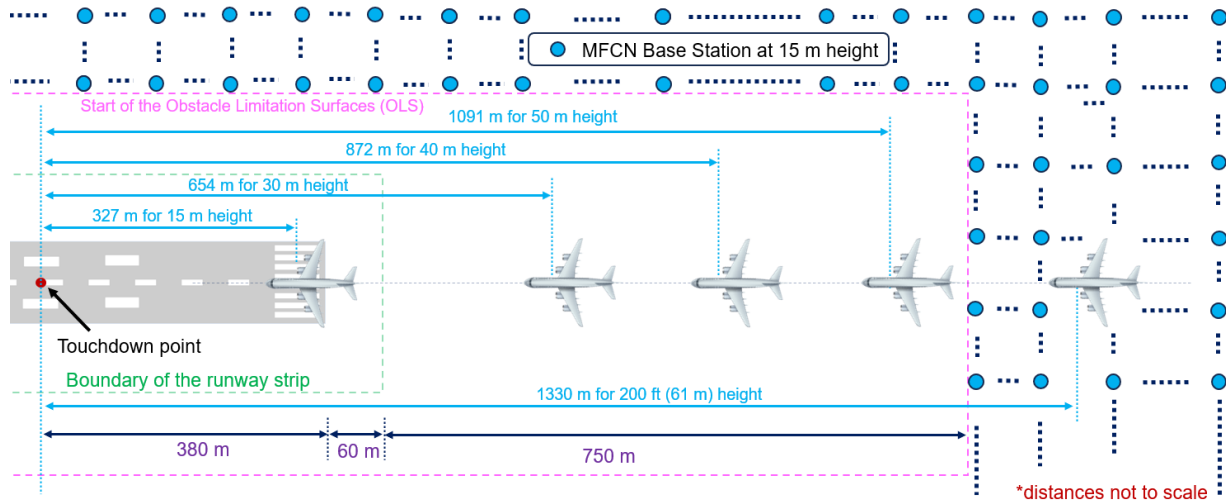

Figure 141: Interference scenario

The result of this scenario is shown in Figure 143. As expected, the hypothetical pointing of the base station to the horizon (i.e. UE at the same height as the base station) increases the interference when the aircraft is at the same height as the base station, i.e. 15 m height.

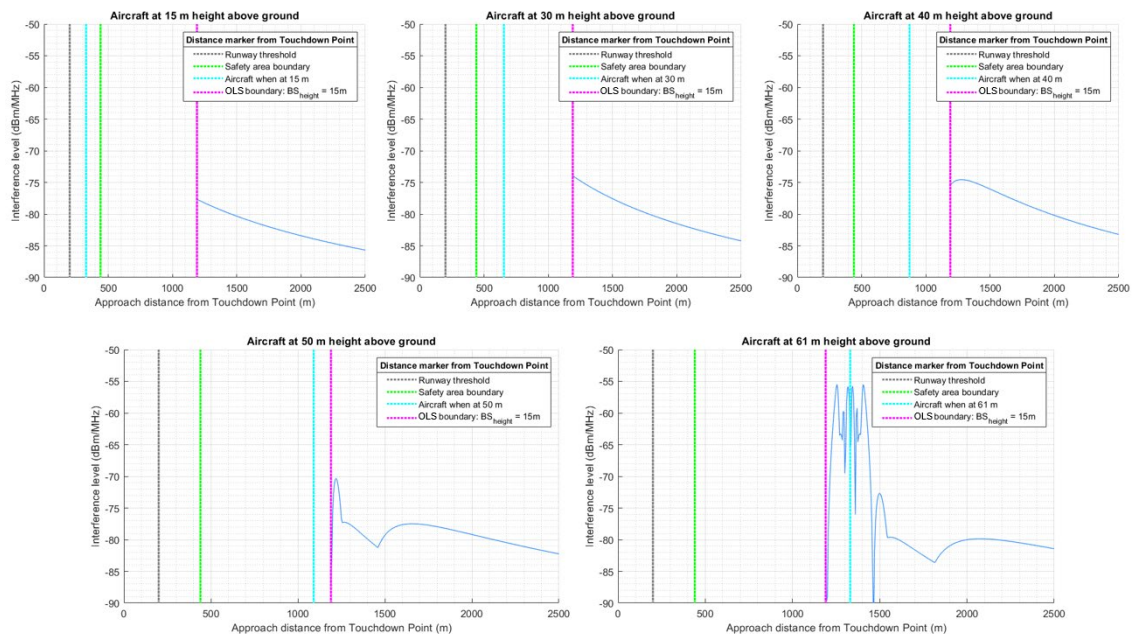

Figure 142: Interference from urban MFCN base station at different aircraft height

As it can be seen in Figure 143, the maximum interference from the base station is when the aircraft is directly above it. Nevertheless, the peak interference is slightly under -55 dBm/MHz which means that there is at least 20 dB margin to the least resilient Radio Altimeter (model Y) even when comparing the ITT at 200 feet (3.7-3.8 GHz range) for the worst-case setup that is being considered from the parametric analysis, assessing the interference at different aircraft heights from 200 feet down to touchdown.

A8.7 SUMMARY

The emissions from the MFCN Base Station to the Radio Altimeter is significantly low for all the MFCN deployment environment when the aircraft is at 200 feet above ground level on the glide path, where the Radio Altimeter breakpoints were determined. This level was compared to the Interference Tolerance Threshold (ITT) for each of the Radio Altimeter models when the aircraft is at this 200 feet height.

The study uses Parameter Set 1 (for both the Radio Altimeter break points and its antenna modelling) as defined in section 5.3 and it shows the significant positive margin to the ITT for every Radio Altimeter model where break point data is available. The MFCN base station are located below the Obstacle Limitation Surface (i.e. obeying the OLS) with a peak *e.i.r.p.* of 78 dBm/100 MHz and oriented (in azimuth) towards the aircraft – forming a near worst-case interference scenario.

The margin to ITT is at least 45 dB for the in-band case (i.e. 3.4-3.8 GHz), for 200 feet, and at least 36 dB margin for 1000 feet ITT. The interference from the MFCN in the unwanted emissions domain (i.e. >4200 MHz) has at least 59 dB margin.

When investigate further, the peak interference from MFCN base station occurs when the aircraft is nearly above the base station and using the worst hypothetical parametric setup considered will still give a margin around 20 dB when compared to the ITT at 200 feet. This conclusion also applies to the situation when considering the aircraft landing from 200 feet down to ground along the glide slope of 2.625°.

ANNEX 9: (STUDY H) COMPATIBILITY STUDY BETWEEN WBB LMP OPERATING IN 3.8-4.2 GHZ AND RADIO ALTIMETER OPERATING IN 4.2-4.4 GHZ USING PARAMETER SET 1

A9.1 BACKGROUND

The study in this Annex is on the compatibility between WBB LMP operating in 3.8-4.2 GHz and Radio Altimeters (RA) operating in 4.2-4.4 GHz. The baseline case considered in this study is pessimistic (near worst-case) where the base station is oriented (in azimuth) towards the aircraft and not taking account of the time-varying AAS beamforming characteristics. If the time aspect is being considered, the risk of interference to Radio Altimeter could significantly be reduced. The study uses the Parameter Set 1 for the Radio Altimeter which includes the break points of the individual Radio Altimeter models and the antenna pattern described in Annex 1.

A9.2 INTERFERENCE SCENARIO

A9.2.1 Obstacle Limitation Surface

The ICAO Annex 14 to the Convention on International Civil Aviation in the International Standards and Recommended Practices (ISRPs) Volume I provides the recommendation related to OLS. Chapter 4 of that document describes the Obstacle Limitation Surface (OLS) around aerodromes which includes the airspace above the inner approach surface, inner transitional surfaces, balked landing surface, etc. These conceptual (imaginary) surfaces are not to be penetrated by any fixed obstacle other than a low-mass and frangible objects required for air navigation purposes. However, it should be noted, that most airports present their own obstacle limitation surface exception that could be more or less stringent.

Figure 143 and Figure 144 illustrates the Obstacle Limitation Surface from the view at the side of the runway and from the view of the approaching aircraft. These figures also include the relevant recommended slope angles from OLS.

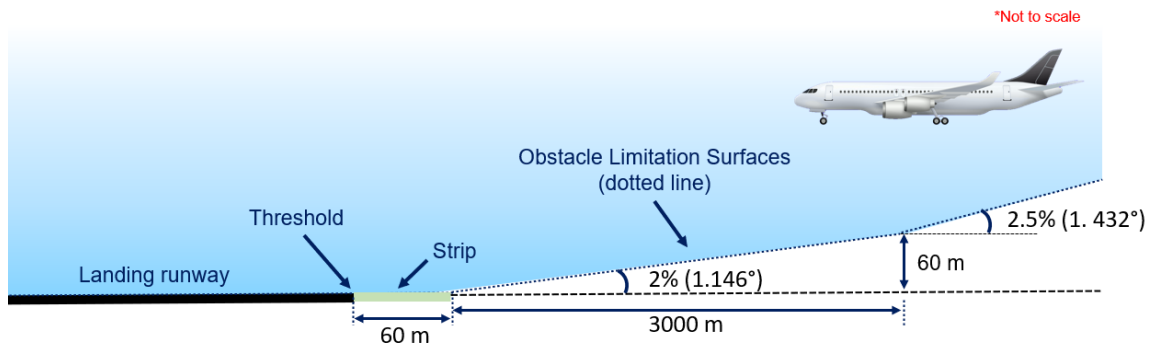

Figure 143: The Obstacle Limitation Surface for the landing approach

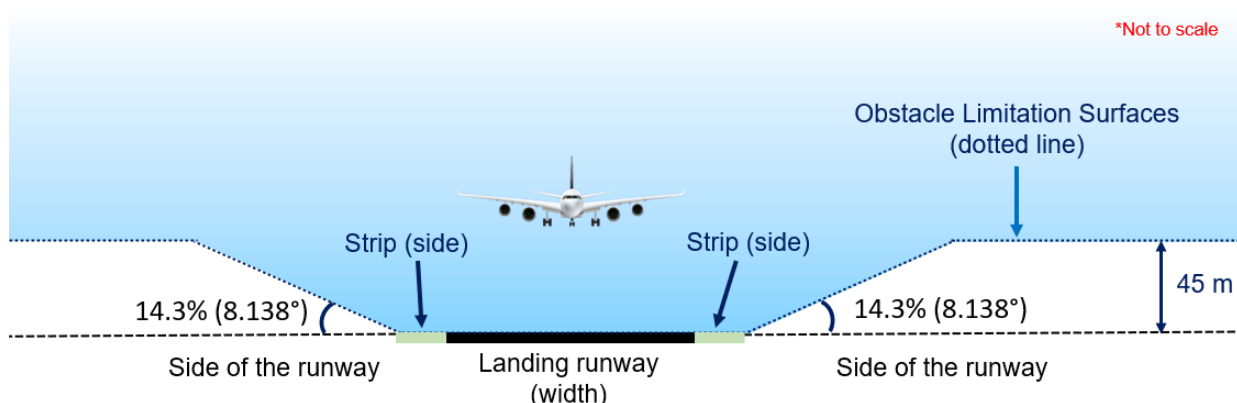

Figure 144: The Obstacle Limitation Surface at both sides of the runway

Figure 145 shows the relevant parameters and areas that are required when defining the interference scenario. The runway end strip length (marked as cx) could be set to 60 m while one half of the width of the runway strip (marked as az) could be set to 140 m.

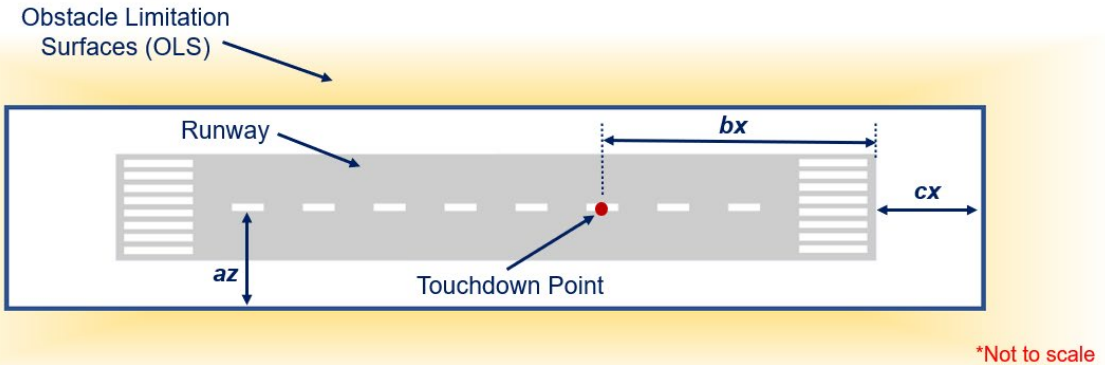

Figure 145: The runway

The OLS defines the surfaces where obstacles should not penetrate (or violate) and objects/obstacles are permitted if they are below the (OLS) s.

A9.2.2 The Baseline Scenario

The interference scenario is as shown in Figure 146 with a glide slope of 3° to the touchdown point²⁰.

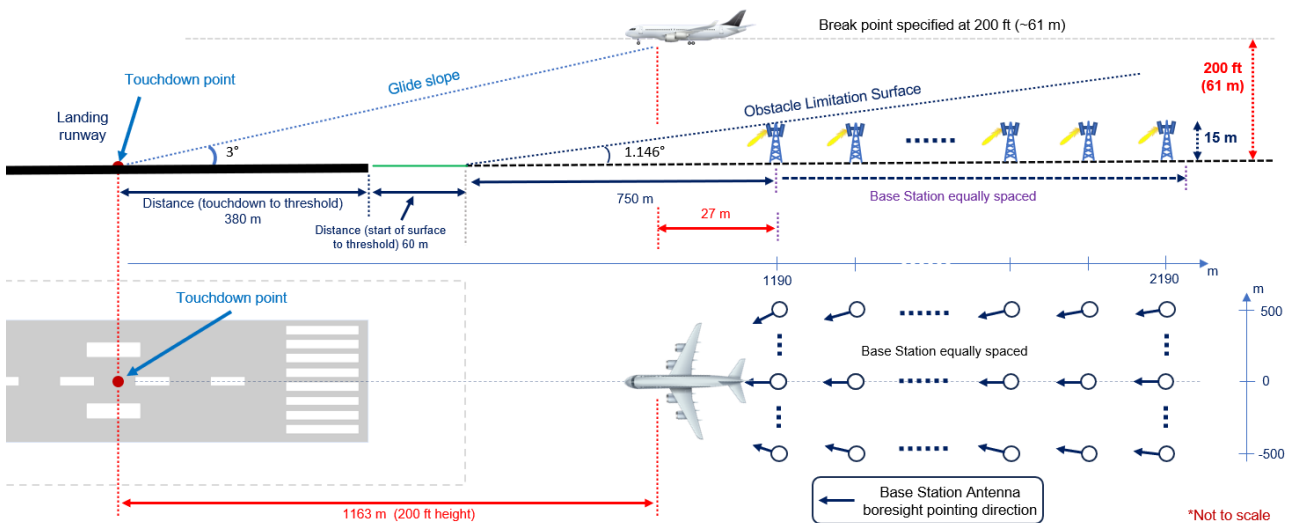

Figure 146: Interference scenario

The WBB LMP base stations are at the height of the 15 m, and they are set directly under the flight path at regular distance intervals from the start of the Obstacle Limitation Surface (OLS) point on the ground. The first base station is 750 m from the start of the OLS to satisfy the height restriction set by this recommended OLS. The closest base station to the aircraft at 200 feet would be around 27 m (ground distance). The study also evaluates emissions from WBB LMP lateral to the flight path as shown in Figure 146. It is worth highlighting that it is sufficient to consider the emissions from a single WBB LMP base station set in a worst-case scenario as this will be the dominant interferer. Hence, this scenario is representative enough to cover the aggregation case involving multiple WBB LMP base station.

²⁰ The aircraft glide slope angle used by the Instrument Landing System (ILS) is usually 3°.

A9.2.3 Orientation of the WBB LMP Base Station – Boresight

The base station antenna gain is at its highest (for a particular elevation angle) in the boresight direction perpendicular to the WBB LMP antenna panel, and this gain is used to evaluate the worst-case emissions from the WBB LMP base station to the Radio Altimeter. Figure 147 is just an illustration of the angular relationship (azimuth) between the WBB LMP base station antenna panel and the Radio Altimeter (represented by the 'Point').

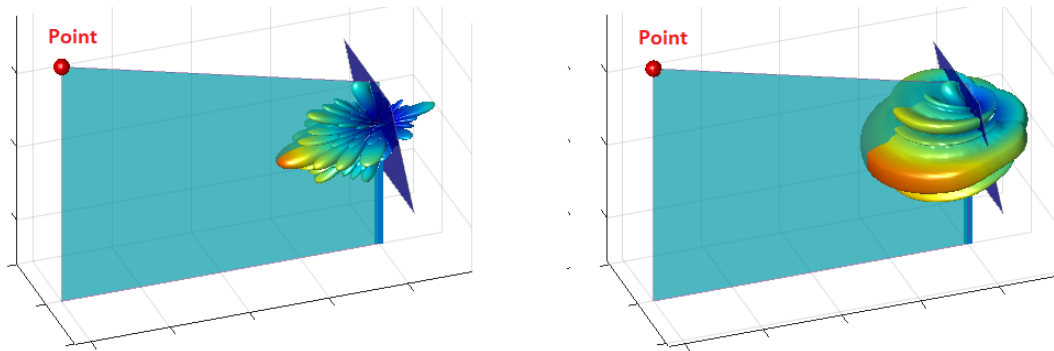

Figure 147: Boresight plane (perpendicular to antenna panel) – (a) antenna gain of an AAS base station, (b) antenna gain envelope of the AAS base station

A9.3 INTERFERENCE TOLERANCE THRESHOLD

The Interference Tolerance Threshold (ITT) is the point where the Radio Altimeter is being evaluated against the emissions from the WBB LMP base station. The ITT is calculated from the breakpoint level of the different Radio Altimeter model at different frequency ranges and height.

A9.3.1 Radio Altimeter Breakpoints and Maximum Interference Levels

Table 87: UC 1 breakpoints between 3.8 to 4.2 GHz at 200 feet AGL in dBm/MHz

Altimeter model	3.8-4.1 GHz	4.1- 4.2 GHz	Source
F	-35 (For 4 GHz worst case sample)	-31 (For 4.1 GHz Worst case sample)	AVSI Report Vol 3 Figure 9-9
L	-8 (For 4000 MHz Percentile Criterion >2% Error)	NDA	AVSI Report Vol 3 Table 8-8
T	NB (> -29.9) (For 4050 MHz Percentile Criterion >2% Error)	NB (> -19.8) (For 4150 MHz Percentile Criterion >2% Error)	AVSI Report Vol 3 Table 6-6
X	-28 (For 3950 MHz Percentile Criterion >2% Error at +25°C)	NDA	AVSI Report Vol 3 Table 8-10
U	NB (> -19.8)	NB (> -19.8)	AVSI Report Vol 3 Table 6-9

Altimeter model	3.8-4.1 GHz	4.1- 4.2 GHz	Source
	(For 4050 MHz NCD Criterion)	(For 4150 MHz NCD Criterion)	
Y	-28 (For 3850 MHz)	NDA	AVSI Report Vol 1 Table 3-1

Note: NB (> VALUE) refers to “No Breakpoint”, meaning normal RA operation up to the maximum 5G signal level tested, where VALUE is the maximum power tested, and the breakpoint would be higher than this level. This tested power level should not be considered as a breakpoint.
 Note: The breakpoints are converted to dBm/MHz
 Note: NDA refers to “no data available”, meaning testing was not conducted for the frequency range.
 Note: NCD refers to “no computed data”
 Note: Altimeter Model X was tested at an altitude of 250 feet AGL
 Note: Altimeter Model L was tested up to a frequency of 4.05 GHz. Altimeter Model X was tested up to a frequency of 4.00 GHz. Altimeter Model Y was tested up to a frequency of 3.98 GHz.
 Note: The breakpoints consider a percentile criterion of +/-2% error and an NCD criterion and do not consider a criterion of a mean error of 0.5%. The mean error deviation of 0.5% is more stringent than the Radio Altimeter height accuracy of +/-3%, across 95% of measured observations that is defined in RTCA DO-155 / EUROCAE ED-30 [22].

Table 88: UC 1 maximum interference levels between 4.2 to 4.4 GHz in dBm/MHz

Altimeter model	200 feet	Source
F	-67 (-22 dB for /MHz conv.)	AVSI Vol II: Table 4-2
L	-75 (Avg. value – 22 dB for /MHz conv.)	AVSI Vol III: Table 8-31
T	-60.8 (For >2% Error -20 dB for /MHz conv.)	AVSI Vol III: Table 6-62
X	-57.8A (Avg. value -22 dB for /MHz conv.)	AVSI Vol III: Table 8-32
U	NB (> -19.8) (For NCD Criterion)	AVSI Vol III: Table 6-63
Y	-64 (-22 dB for /MHz conv.)	AVSI Vol II: Table 4-2

A Model X was tested at an altitude of 250 feet AGL.
 Note: NB (> VALUE) refers to “No Breakpoint”, meaning normal RA operation up to the maximum 5G signal level tested, where VALUE is the maximum power tested, and the breakpoint would be higher than this level. This tested power level should not be considered as a breakpoint. Note: The breakpoints are converted to dBm/MHz.
 Note: The breakpoints are converted to dBm/MHz.
 Note: NDA refers to “no data available,” meaning testing was not conducted for the frequency range.
 Note: NCD refers to “no computed data”
 Note: Altimeters X and L have thresholds corresponding to the average breakpoint tested. While the Manufacturer tests for these altimeters between 4.2 to 4.4 GHz in AVSI report Volume 3 does not provide the worst case but the average value and standard deviation, a 3sigma deviation may overestimate the ITT. Thus, it is proposed that the average value is used for these cases due to lack of information of the worst-case performance amongst the tested units. The manufacturer recommended using the average value minus three times the standard deviation for calculation of the ITT.
 Note: The breakpoints consider a percentile criterion of +/-2% error and an NCD criterion and do not consider a criterion of a mean error of 0.5%. The mean error deviation of 0.5% is more stringent than the Radio Altimeter height accuracy of +/-3%, across 95% of measured observations that is defined in RTCA DO-155 / EUROCAE ED-30 [22].

A9.3.2 The interference tolerance threshold (ITT)

The provided breakpoints can be converted to an interference tolerance threshold (ITT) using Equation 1.

$$ITT = BP - BTI_f - EE_f - U\&T_f$$

where:

- ITT : The interference tolerance threshold at the input to the Radio Altimeter Transceiver Receive Port. The interference tolerance threshold is defined for a specific altitude and frequency offset as the highest power for which performance is still acceptable (dBm/MHz);
- BP : The breakpoint of the altimeter (dBm/MHz);
- BTI_f : A BP -to- ITT backoff factor that accounts for the step-size used in the AVSI testing. (dB);
- EE_f : An experimental error factor (dB);
- $U\&T_f$: A unit-to-unit and temperature interference tolerance performance variation factor (dB).

The ITT and breakpoints are derived considering an WBB LMP bandwidth of 100 MHz in the 3.8-4.2 GHz frequency range.

The necessary constants to convert the RA Breakpoints to Interference Tolerance Thresholds are provided in Table 89 and the breakpoint for each of the altimeter model is in Table 88 and Table 89

Table 89: Constants for Equation 1 for Specified Altimeter Models

Parameter	Unit	Value
BTI_f	dB	1
EE_f	dB	1
$U\&T_f$	dB	0 (for Altimeter model F, L and X) 4 (for Altimeter model T, U, and Y)

For altimeter model F, $U\&T_f$ is chosen to be 0 dB as the value taken from AVSI Report Volume 3 is the worst-case sample which in our view takes account of this variation factor. The rest of the parameters in this table was agreed.

The resulting interference tolerance thresholds (ITT) for 200 feet are shown in Table 89.

Table 90: Interference tolerance thresholds (ITT) for 200 feet in dBm/MHz

Frequency range (GHz)	Radio Altimeter Model					
	F	L	T	X	U	Y
3.8-4.1	-37	-10	-	-30	-	-34
4.1-4.2	-33	-	-	-	-	-
4.2-4.4	-69	-77	-66.8	-59.8	-	-70

A9.4 PARAMETERS USED IN THE STUDY

A9.4.1 Radio Altimeter

The antenna Radio Altimeter antenna gain is shown in Table 91.

Table 91: Radio Altimeter antenna gain

Frequency range	Peak gain and 3 dB BW	Cable loss	Pattern
3.4-4.1 GHz	0 dBi, 60° 3 dB-BW	3 dB	Report ITU-R M.2319 (Equation A-3.6)
4.1-4.2 GHz	6 dBi, 60° 3 dB-BW	3 dB	
4.2-4.4 GHz	9 dBi, 60° 3 dB-BW	3 dB	

Figure 148 illustrates the Radio Altimeter antenna gain at different frequencies. The study evaluates 2 frequency ranges for the blocking case, 3.4-4.1 GHz and 4.1-4.2 GHz, and the unwanted emissions domain at 4.2-4.4 GHz.

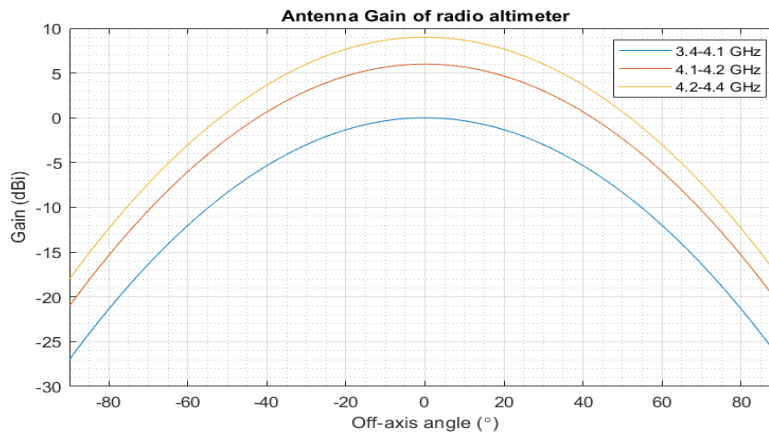

Figure 148: Radio Altimeter antenna gain

Figure 149 is a 3-dimensional plot of the Radio Altimeter antenna gain at 4.2-4.4 GHz, illustrating that the antenna gain pattern is a function of the off-axis angle from the boresight of the antenna.

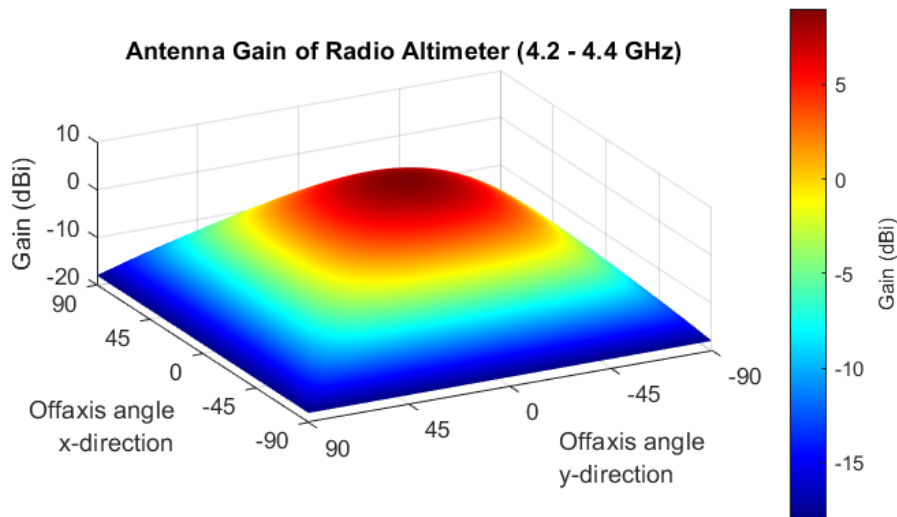

Figure 149: 3D Radio Altimeter antenna gain

A9.4.2 Medium Power WBB LMP 3.8-4.2 GHz

Table 92 shows the relevant WBB Medium Power (MP) base station parameters used in the study. These parameters are consistent with base station deploying sub-array AAS, particularly where the vertical coverage range is limited to the coverage cell.

Table 92: Relevant WBB Medium Power parameters (AAS)

Parameter	Value
Base Station Height (m)	15
Cell range (m)	400
Mechanical downtilt (°)	6
Base station vertical coverage range (°)	90-100
Maximum base station output power/sector (<i>e.i.r.p.</i>) (dBm/100 MHz)	51
Antenna configuration (Row x Column)	4 x 8

The Medium Power WBB LMP base station in band pattern is shown in Figure 150.

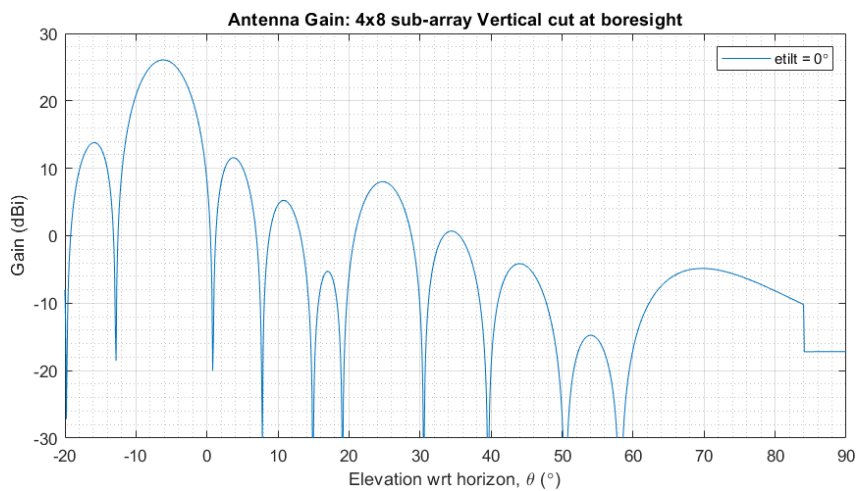

Figure 150: WBB Medium Power antenna pattern without any electrical steering

The study looks at the worst emission configuration from the Medium Power WBB LMP parameters used and the highest emission comes from the horizontal boresight direction. Although the vertical coverage range is defined as 90°-100°, the actual cell range will define the minimum electrical tilt for the AAS as illustrated in Figure 151.

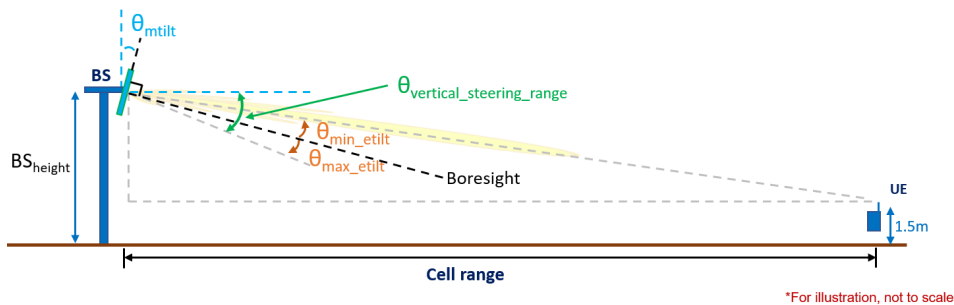

Figure 151: Relation between cell range and the minimum electrical tilt (vertical)

Therefore, for a cell range of 400 m and a mechanical downtilt of 6° the minimum electrical tilt, θ_{min_etilt} , will be -4.1° and with a maximum electrical tilt, θ_{max_etilt} , of 4°, and the envelope of the Medium Power WBB LMP base station is shown in Figure 152.

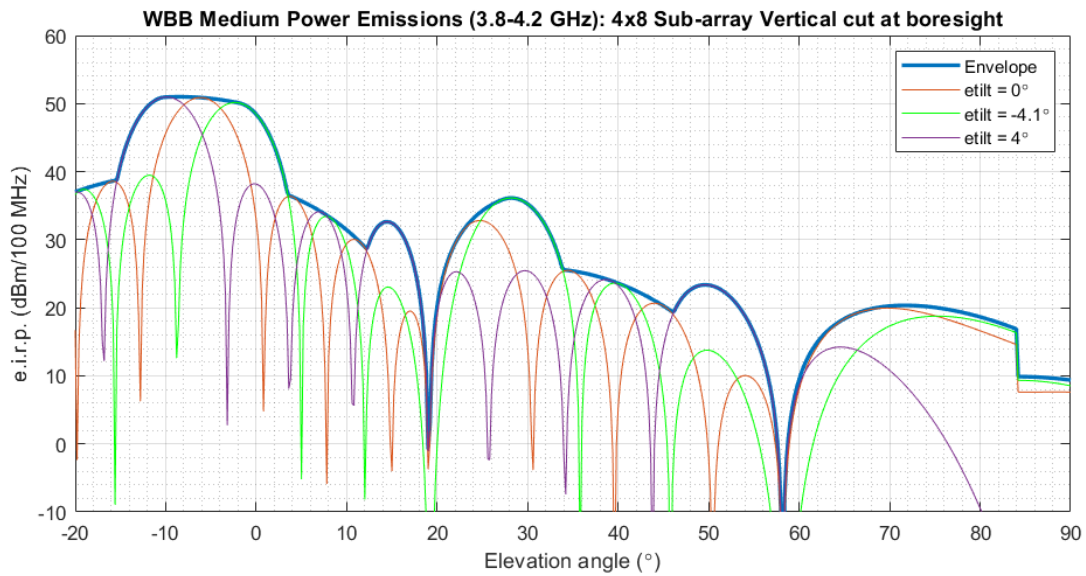

Figure 152: WBB Medium Power emissions with 4x8 AAS sub-array

A9.4.3 The unwanted emissions domain for Medium Power WBB LMP AAS Base Station

The transitional and baseline power limits used in the study are shown in Table 93. The spurious emissions domain for the base station for this frequency band starts at 40 MHz from the band edge (i.e. 4200 MHz) and the -30 dBm/MHz TRP limit is defined in the current ERC Recommendation 74-01 [4] for AAS.

Table 93: Transitional power limits for WBB Medium Power AAS BS (ETSI TS 138 104, section 9.7.4, “OTA operating band unwanted emissions” [38])

BEM element	Frequency range	AAS TRP limit per cell
Transitional region	-5 to 0 MHz offset from lower block edge 0 to 5 MHz offset from upper block edge	+0.94 dBm/5 MHz
Transitional region	-10 to -5 MHz offset from lower block edge 5 to 10 MHz offset from upper block edge	-3 dBm/5 MHz
Baseline	Below -10 MHz offset from lower block edge. Above 10 MHz offset from upper block edge.	-3 dBm/5 MHz

The BS transitional region BEM elements are based on the assumption that the emissions come from a Micro BS. In a multi-sector base station, the radiated power limit applies to each one of the individual sectors.
 Note: The spurious emission domain for the base station in these frequency bands start 40 MHz from the band edge and the corresponding limits are defined in current ERC Recommendation 74-01

Noting that the Radio Altimeter occupies at least 100 MHz, the unwanted emissions from WBB LMP base station are calculated based on 100 MHz. Considering larger bandwidth would reduce the overall emissions from the WBB LMP base station when it is scaled back to 1 MHz, therefore, the interference scenario considered in this contribution is more pessimistic.

Since the Radio Altimeter is operating in the immediate adjacent frequency, the fully correlated AAS antenna pattern is used. This assumes that the WBB LMP base station is operating at the top of the 3.8-4.2 GHz frequency range with the Radio Altimeter operating immediately at the lower part of the 4.2-4.4 GHz frequency range, meaning that this is the highest interference level scenario to consider for the unwanted emissions case from the WBB LMP base station.

A9.4.4 Propagation Loss

The frequency used to calculate the path loss is at 4.0 GHz, 4.15 GHz, and 4.25 GHz. Since the propagation is from the base station to the Radio Altimeter, only free-space path loss is considered without any clutter. Figure 153 shows the free-space path loss at these frequencies, and at 600 m the path loss difference between 4.0 GHz and 4.25 GHz is 0.5 dB.

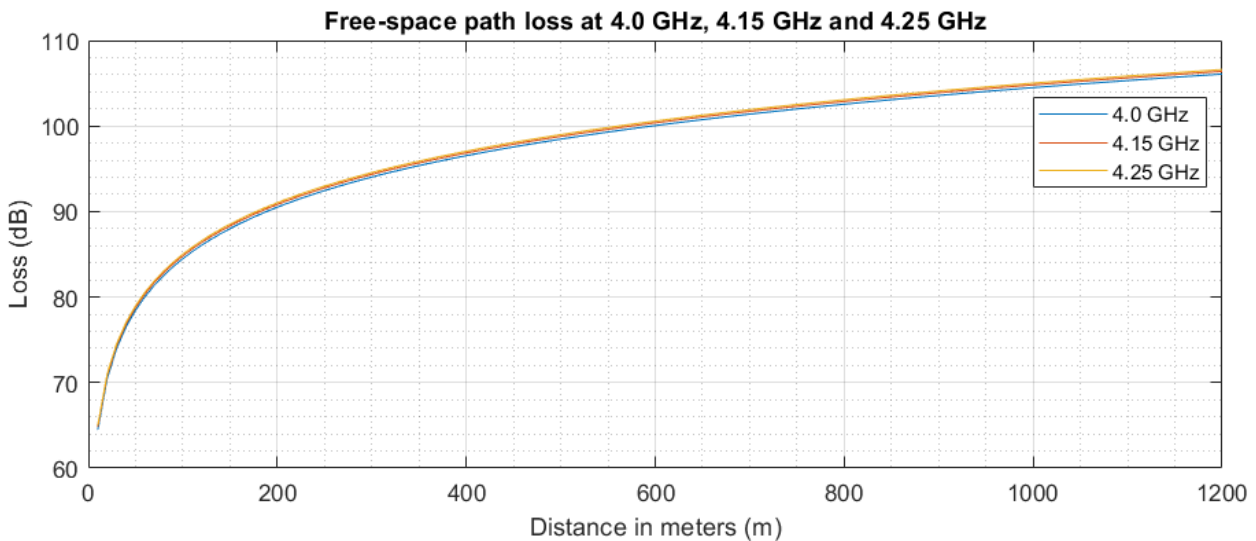

Figure 153: Path loss

In addition to the free-space path loss, a 1.5 dB polarisation loss is included as the interference analysis is based on main-beam to main-beam (utilising information from previous studies²¹ involving dual-polarised IMT with other services).

A9.5 SIMULATION RESULTS

32 The Interference Tolerance Threshold (ITT) in **Table 89** is compared against the WBB Medium Power base station power level at the Radio Altimeter (as shown in Equation 28):

$$I_{WBB} = WBB_{\text{emission}} - PL + \text{Gain}_{RA} - RA_{\text{cable}}$$

Equation 33

where:

- I_{WBB} : the WBB interference power at the Radio Altimeter where it's compared to ITT
- WBB_{emission} : the WBB Medium Power base station emissions
- PL: the propagation loss which encompasses the path loss and polarisation loss
- Gain_{RA} : the antenna gain of the Radio Altimeter
- RA_{cable} : the cable loss from the Radio Altimeter side

A9.5.1 Medium Power WBB LMP Interference (in-band)

The Medium Power WBB LMP base station interference power from the in-band 3.8-4.1 GHz at the Radio Altimeter antenna (taking account of the antenna gain and the cable loss) is shown in Figure 154 and Figure 155.

²¹ Polarisation loss has been extensively discussed and the conclusion have been embedded into <https://www.itu.int/md/R15-TG5.1-C-0478/en>, annex 1

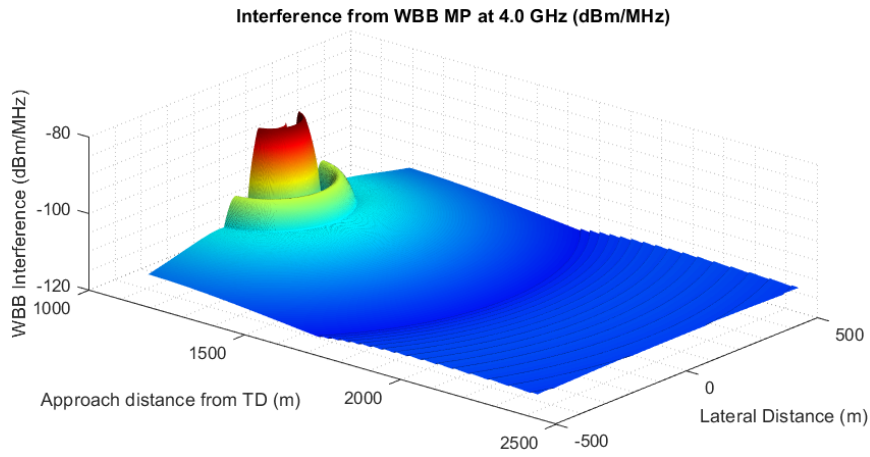

Figure 154: Medium Power WBB LMP base station interference at the Radio Altimeter antenna (4.0 GHz)

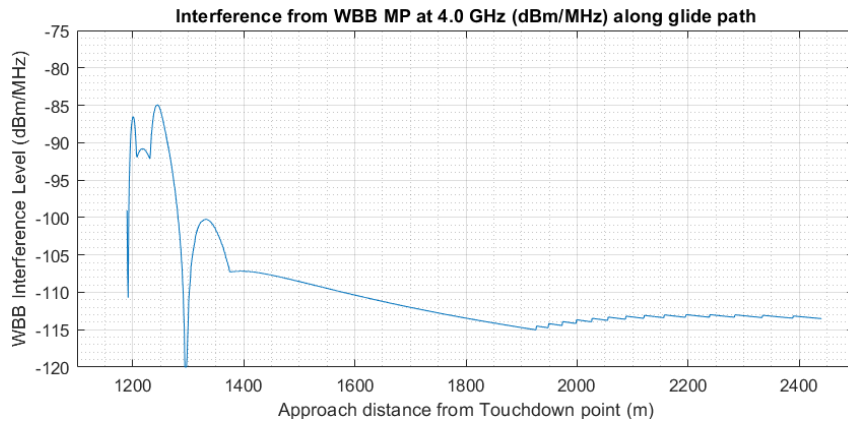

Figure 155: Interference from Medium Power WBB LMP at the Radio Altimeter antenna along glide path (4.0 GHz)

The Medium Power WBB LMP base station interference from the in-band 4.1-4.2 GHz at the Radio Altimeter antenna (taking account of the antenna gain and cable loss) is show in Figure 156 and Figure 157.

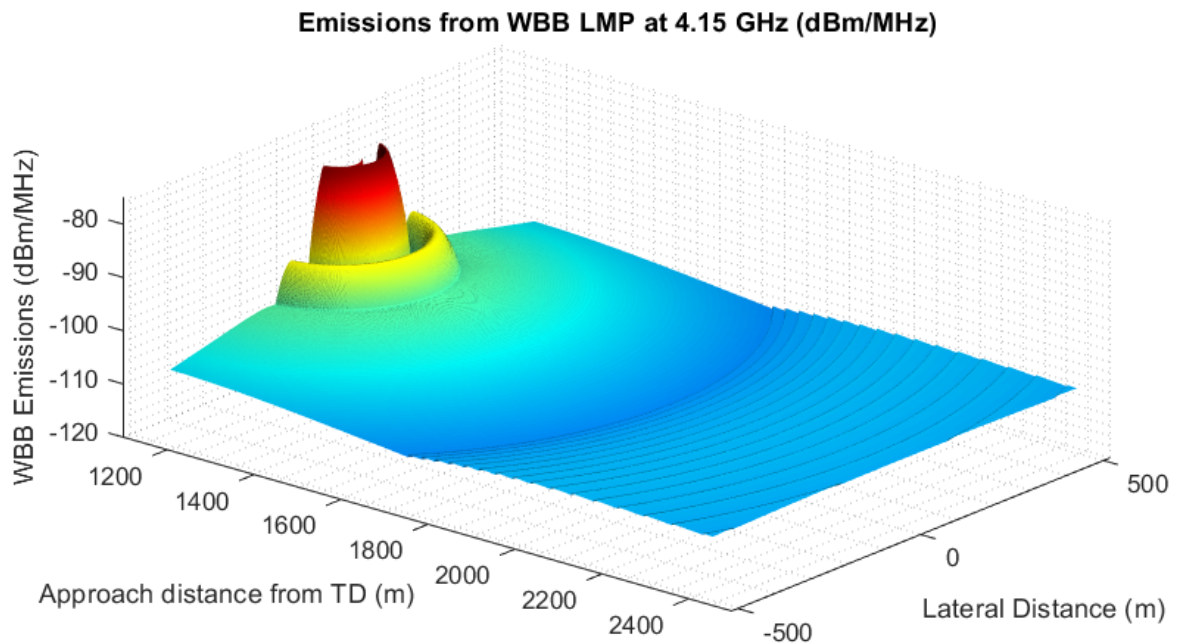

Figure 156: Medium Power WBB LMP base station interference at the Radio Altimeter antenna (4.15 GHz)

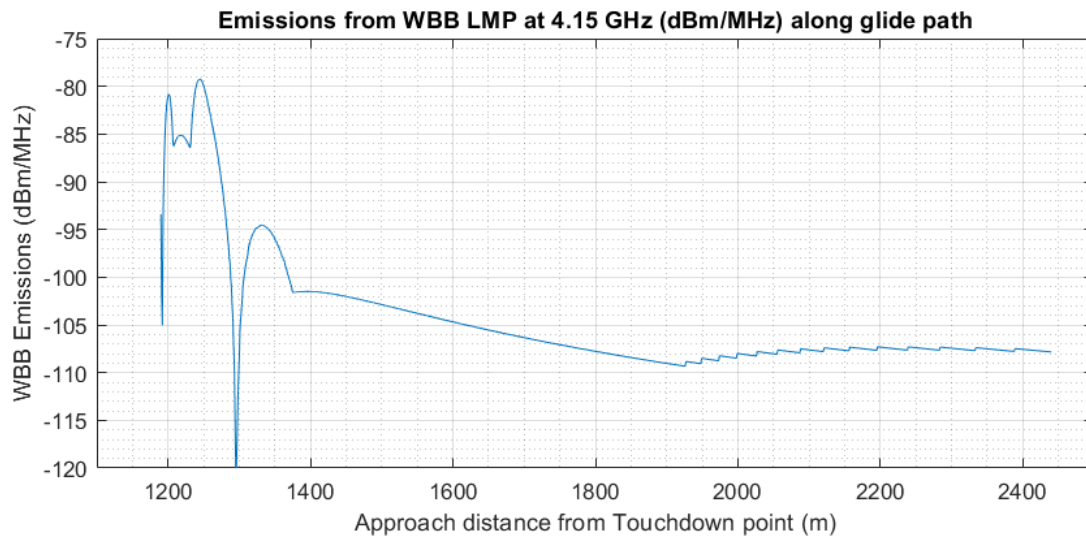

Figure 157: Interference from Medium Power WBB LMP at the Radio Altimeter antenna along glide path (4.15 GHz)

A9.5.2 Medium Power WBB LMP Interference (unwanted emissions)

The Medium Power WBB LMP base station interference power from the unwanted emissions domain, i.e. 4.2-4.4 GHz, at the Radio Altimeter antenna (taking account of the antenna gain and the cable loss) is shown in Figure 158 and Figure 159.

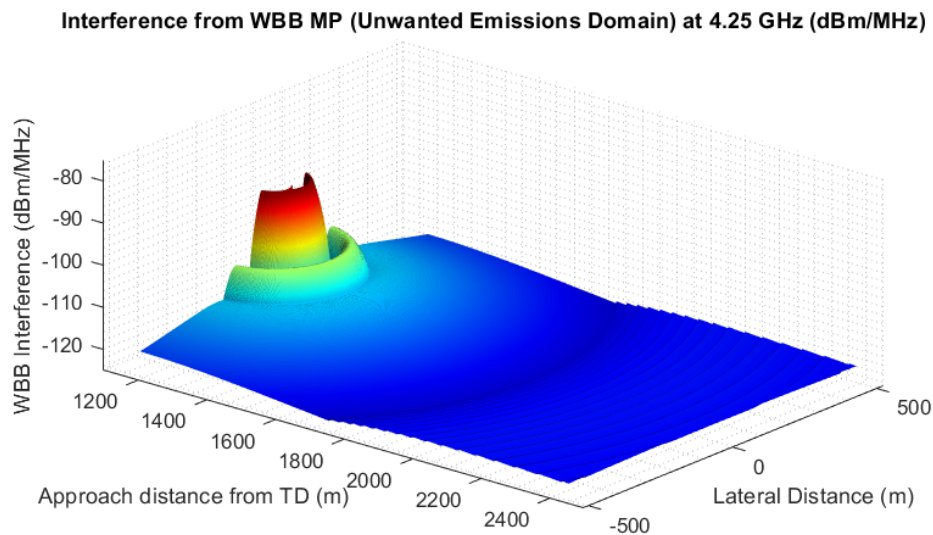

Figure 158: Medium Power WBB LMP base station interference from the unwanted emissions domain at the Radio Altimeter antenna (4.25 GHz)

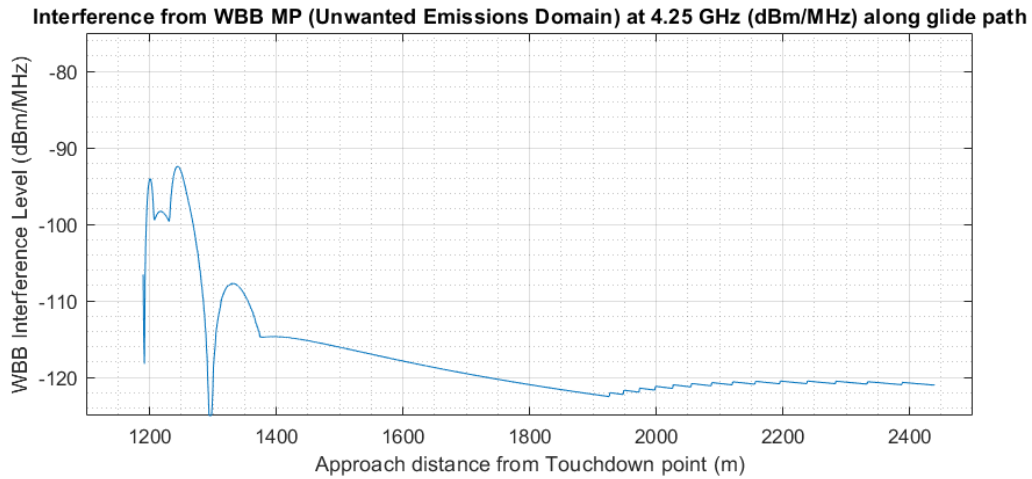

Figure 159: Interference from Medium Power WBB LMP

in the unwanted emissions domain at the Radio Altimeter antenna along glide path (4.25 GHz)

A9.5.3 Comparison to the Interference Tolerance Threshold

The ITT levels for the various Radio Altimeter model can be found in Table 89, and the margin against the WBB LMP emissions for the 3.4-4.1 GHz and 4.1-4.2 GHz range can be seen in Figure 160 and Figure 161 respectively. This margin is more than 48 dB for the worst altimeter model for both frequency ranges.

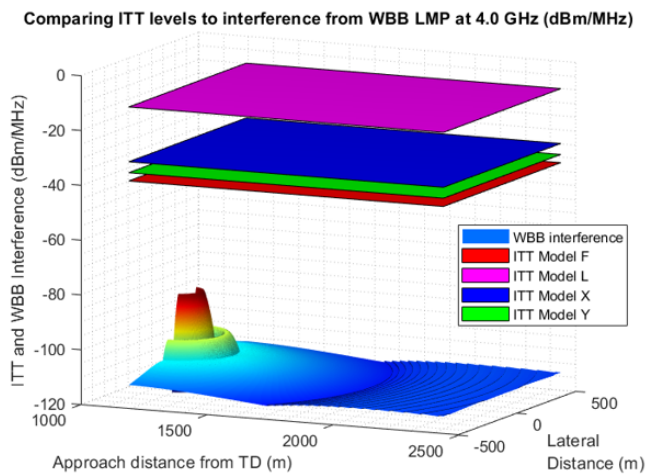
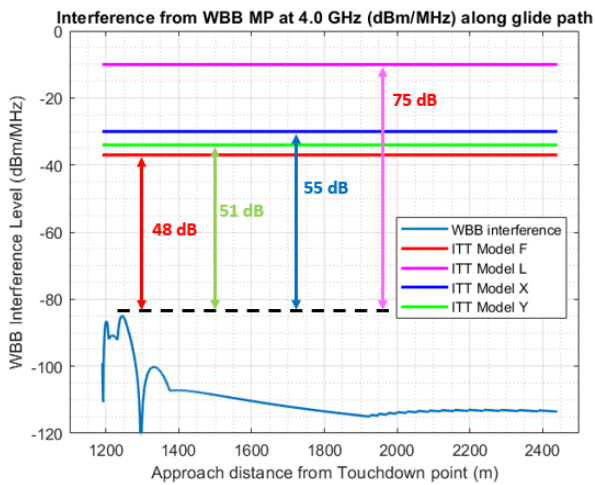

Figure 160: Comparing the ITT levels with the WBB emissions at 4.0 GHz

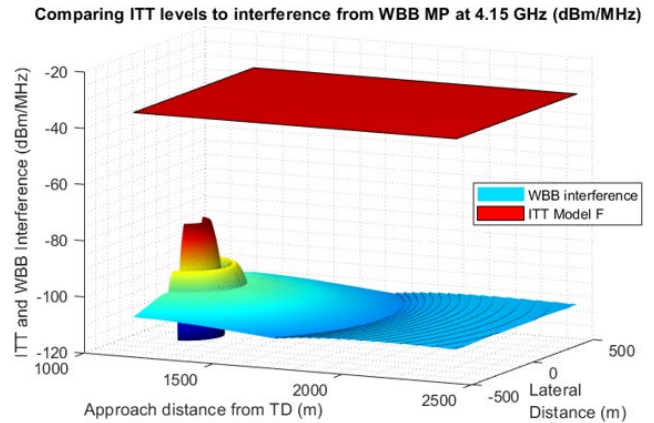
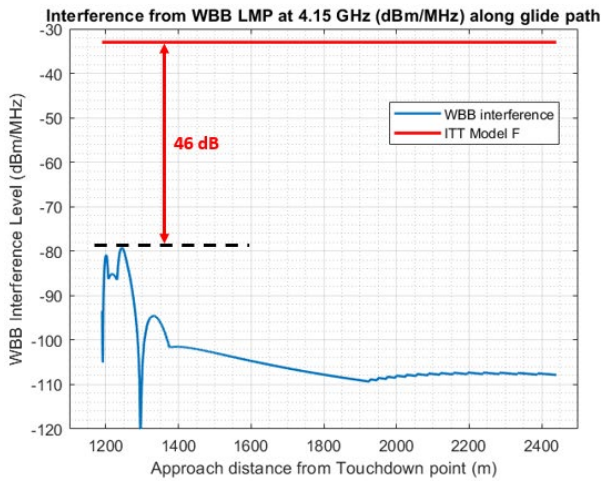

Figure 161: Comparing the ITT levels with the WBB emissions at 4.15 GHz

For the Medium Power WBB LMP base station unwanted emissions domain (i.e. 4.2-4.4 GHz), the margin is in excess of 15 as shown in Figure 162.

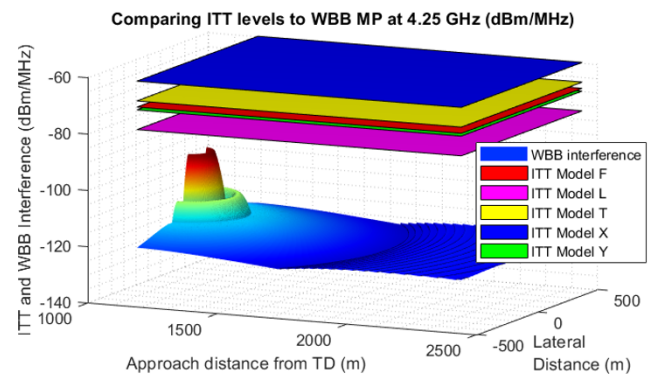
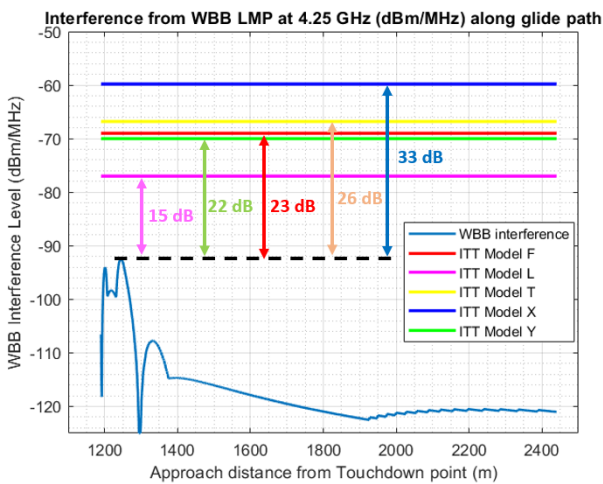

Figure 162: Comparing the ITT levels with the WBB unwanted emissions at 4.25 GHz

The margin to the ITT for the different Radio Altimeter models at 200 feet for the different frequency ranges is summarised in Table 94.

Table 94: Margin to the interference tolerance thresholds (ITT) for 200 feet in dB

Frequency range (GHz)	Radio Altimeter Model					
	F	L	T	X	U	Y
3.8-4.1	48	75	NA	55	NA	51
4.1-4.2	46	NA	NA	NA	NA	NA
4.2-4.4	23	15	26	33	NA	22

Note: NA in the table is due to the lack of information or no breakpoints from the Radio Altimeter models in those frequencies.

A9.6 PARAMETRIC ANALYSIS

A9.6.1 Base station height

The base station height has an impact on the level of margin because the base station can be situated nearer to the runway while obeying the Obstacle Limitation Surface (OLS) criteria. Figure 163 illustrates the new interference scenario.

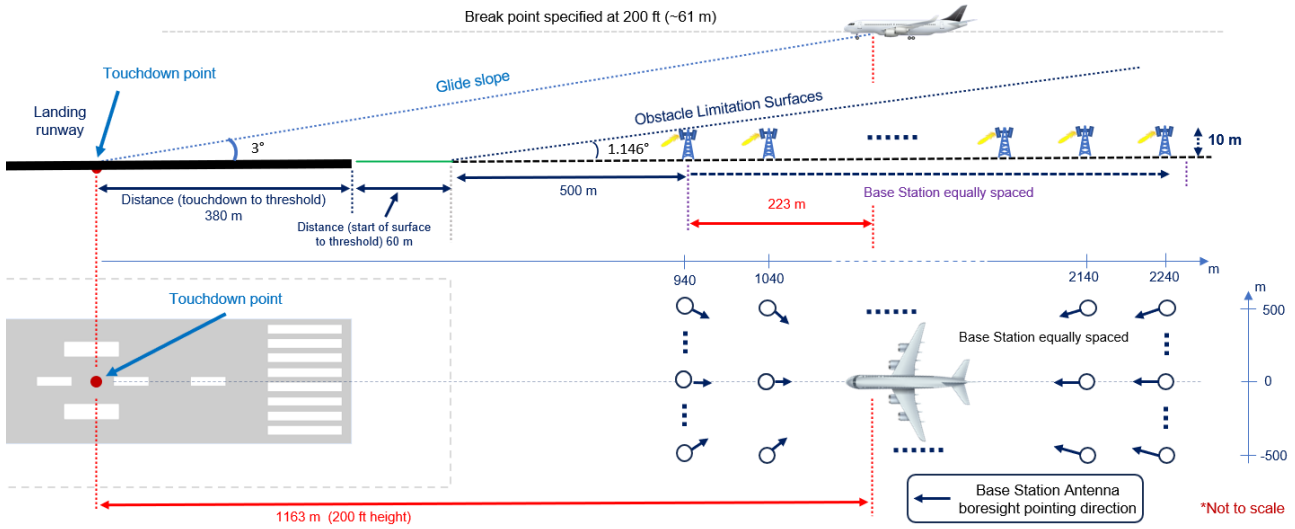

Figure 163: Scenario when the base station height is 10 m

The minimum base station distance from the touchdown point will drop from 1190 m to 940 m. This means that there is a need to consider the situation where the base station could be directly under the Radio Altimeter.

The impact for changing the base station height from 15 m to 10 m is shown in Figure 164.

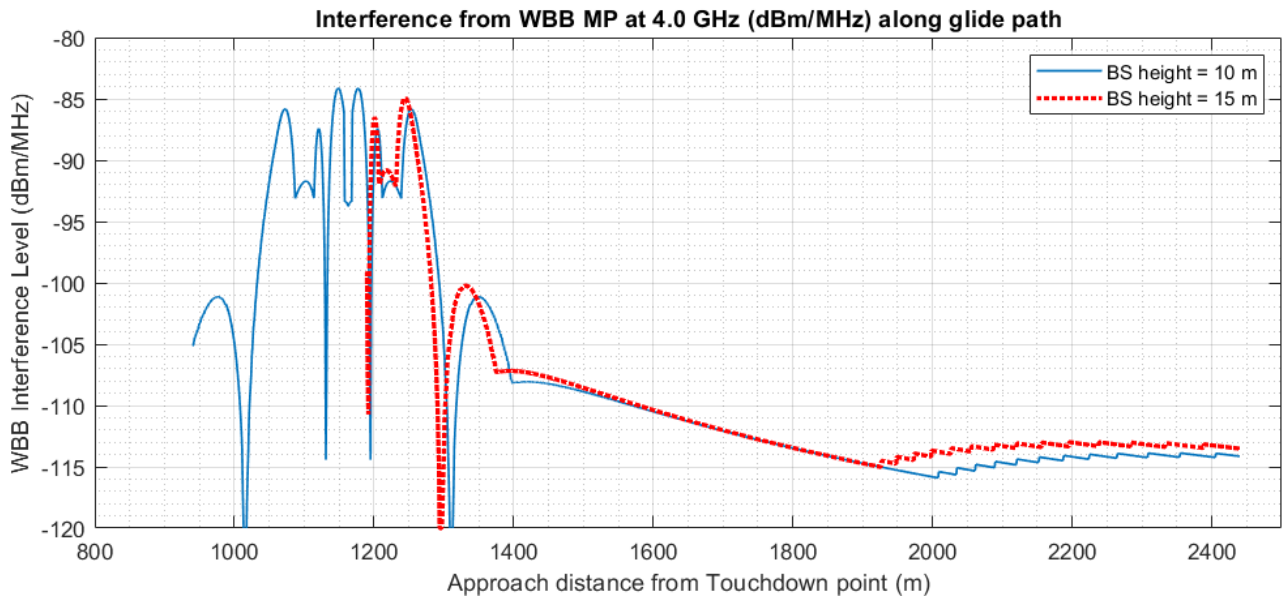

Figure 164: Impact to the WBB LMP emissions from BS height of 15 m to 10 m

A9.6.2 Antenna Electrical Steering

When the cell radius is defined as 400 m (with a 6° mechanical downtilt) in the baseline study, the minimum electrical steering is found to be -4.1° (i.e. 91.9° vertical angle which is within the vertical coverage range

parameter), and this minimum electrical steering can be as low as -6.0° as the vertical coverage range is defined as 90° - 100° . Figure 165 shows the difference between the baseline and this theoretical minimum steering angle. 90° is essentially pointing the beam towards the horizon which requires the base station to be at the same height as the user equipment (UE). As shown in Figure 165, it affects only a small set of elevation angles and the overall impact when evaluating together with other factors will be minimum especially the highest emissions are when the base station is nearly directly below the aircraft (i.e. high elevation angle from the WBB base station perspective).

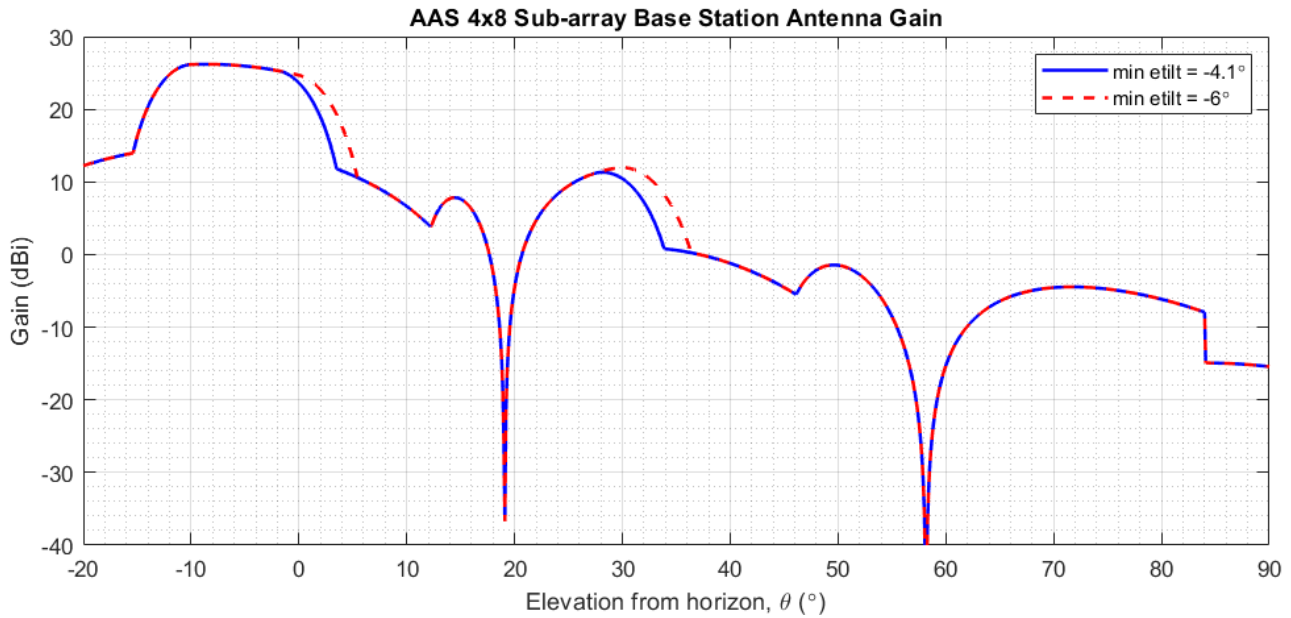

Figure 165: Antenna pattern for different minimum electrical tilt

A9.6.3 Altimeter antenna gain on aircraft roll

Applying the aircraft roll will have an impact to the Radio Altimeter antenna gain evaluated for the study but the impact to the base stations along the glide path is minimal as shown in Figure 166. The Radio Altimeter antenna gain is highest along the glide path when aircraft roll is not considered, therefore, setting this baseline scenario near worst-case along the glide path.

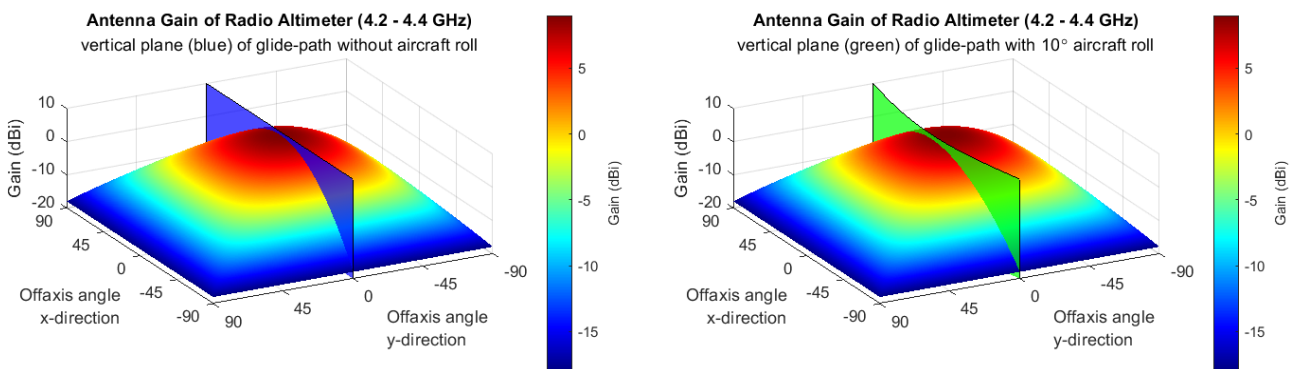

Figure 166: Impact of roll to the Radio Altimeter antenna gain

It is worth pointing out that the baseline study does not evaluate the aircraft (Radio Altimeter) at different height (other than 200 feet) along the glide path, but this conclusion also applies.

A9.7 SUMMARY

The emissions from the WBB LMP Base Station to the Radio Altimeter is significantly low for the scenario considered at 200 feet above ground level where the Radio Altimeter breakpoints were determined. This level was compared to the Interference Tolerance Threshold (ITT) for each of the Radio Altimeter model.

The margin to the ITT shown in Table 94 is repeated below (Table 95).

Table 95: Margin to the interference tolerance thresholds (ITT) for 200 feet in dB

Frequency range (GHz)	Radio Altimeter Model					
	F	L	T	X	U	Y
3.8-4.1	48	75	NA	55	NA	51
4.1-4.2	46	NA	NA	NA	NA	NA
4.2-4.4	23	15	26	33	NA	22

Note: NA in the table is due to the lack of information or no breakpoints from the Radio Altimeter models in those frequencies.

Table 95 shows that the margin to ITT is at least 46 dB when Medium Power WBB LMP operates immediately adjacent to the 4200 MHz frequency boundary. With this same setup, the interference from the Medium Power WBB LMP in the unwanted emissions domain (i.e. >4200 MHz) has at least 15 dB margin.

The interference scenario at 1000 feet (where the other breakpoints were measured) is less critical as the distance between the Radio Altimeter and the WBB base stations are much larger which accounts for higher path loss. Although the breakpoints are more sensitive at 1000 feet, the additional path loss compensates this, resulting in better coexistence between the WBB LMP and the Radio Altimeters.

The baseline study in this main contribution (i.e. section A9.2 to) is considered to be pessimistic (near worst-case) where the base station is considering pointing towards the aircraft and not taking account of the time-varying AAS beamforming characteristics. If the time aspect is being taken into account, the risk of interference to Radio Altimeter could significantly be reduced.(See Study I in ANNEX 10: on the calculation of Peak Interference Level from BS operating in the Frequency Range 3.4-3.8 GHz to RA Antenna at Altimeters of 200 feet and 1000 feet Using Parameter Set 1).

ANNEX 10: (STUDY I) CALCULATION OF PEAK INTERFERENCE LEVEL FROM BS OPERATING IN THE FREQUENCY RANGE 3.4–3.8 GHZ TO RA ANTENNA AT ALTIMETERS OF 200 FEET AND 1000 FEET USING PARAMETER SET 1

A10.1 SYSTEM CHARACTERISTICS FOR STUDIES

A10.1.1 MFCN

Basically, the parameters of IMT refer to 0 which is also based on WP 5D assumptions for IMT-related WRC-19 agenda item 1.2 .

A10.1.1.1 Beamforming AAS characteristics

The BS characteristics refers the assumption of WRC-19 Agenda item 1.2 for IMT identification covered to the frequency range 3.8-4.2 GHz.

Table 96: Beamforming AAS characteristics for IMT in 1710-4990 MHz

Parameter	Notation	With Sub-array (SA)	No sub-array (SA)
Antenna pattern (dBi)	G_{AAS}	Extended AAS Model 3GPP TR 38.803 (Section 5.2.3.2.4), reported in Table 2.	Refer to section 5 of Recommendation ITU-R M.2101
Gain at boresight	$\max G_{AAS}$	26 dBi	24.5 dBi
Element gain (dBi) (Note 1)	$G_{E,max}$	6.4	
Antenna polarization	N.A.	Linear $\pm 45^\circ$	
Array Ohmic loss (dB) (Note 1)	N.A.	2	
Horizontal/vertical 3 dB beam width of single element (Degree)	$\varphi_{3db}/\theta_{3db}$	90° for H, 65° for V	
Horizontal/vertical front-to-back ratio (dB)	A_m, SLA_V	30 dB for both H/V	
Antenna polarization	N.A.	Linear $\pm 45^\circ$	
Antenna array configuration (Row \times Column) (Note 2)	$M \times N$	4 \times 8 elements	8 \times 8 elements
Horizontal/Vertical radiating element/sub-array spacing	d_h, d_v	0.5 of wavelength for H, 2.1 of wavelength for V	0.5 of wavelength for H, 0.7 of wavelength for V
Number of element rows in sub-array	M_{sub}	3	N.A.
Vertical radiating element spacing in sub-array	$d_{v,sub}$	0.7 of wavelength of V	N.A.
Pre-set sub-array down-tilt, θ subtilt (degrees)	$\theta_{subtilt}$	3	N.A.
<p>Note 1: The element gain includes the ohmic loss and is per polarization. This means that this ohmic loss parameter is not needed for the calculation of the BS composite antenna gain and <i>e.i.r.p.</i></p> <p>Note 2: For the small/micro cell case, 8 \times 8 means there are 8 vertical and 8 horizontal radiating elements. For the extended AAS model case, 4 \times 8 means there are 4 vertical and 8 horizontal radiating sub-arrays.</p>			

A10.1.1.2 Base station characteristics for each deployment type

The MCFN base stations in the 3.4-3.8 GHz band for four deployment types: Rural, Urban, Suburban Macro and Urban Micro. Indoor cells are not considered.

Table 97: Base station characteristics in MCFN and WBB LMP bands

Parameter	MCFN 3.4-3.8 GHz			
	Rural Macro	Suburban macro	Urban macro	Urban Micro
Bandwidth BW (MHz)	100			
e.i.r.p. at boresight (dBm)	78 (not consider 78 (Note 1))			61.53
Antenna height h _{AAS} (m)	35	25	20	6
Cell radius	1600 m	800 m	400 m	-
AAS model	Sub-array (SA)			No SA
Mechanical downtilt (degrees)	3	6	6	0 to 10 (to apply 0 as worst case)
horizontal coverage range (degrees)	±60° (φ _{coverage} = 60°)			
vertical coverage range (degrees) (Notes 3,4)	90° (Note 5) to 100° (θ _{coverage} = 10°)			90° (Note 5) to 120° (Note 5) (θ _{coverage} = 30°)
Note 1: 78 dBm is the typical EIRP value of 5G currently deployed in France. Note 2: TRP calculation take into account 26 dBi antenna gain for AAS with Sub-array (SA) and 24.5 dBi for AAS without SA. Note 3: The vertical coverage is given in global coordinate system, i.e. 90° being horizon. Note 4: The vertical coverage includes the mechanical downtilt. Note 5: There is currently no regulation limiting the AAS pointing direction above the horizon, so cases where the vertical coverage angles are lower than 90° (above the horizon) must be considered as well.				

A10.1.2 Radio Altimeter

Antenna pattern gain of Radio Altimeter is applied with Report ITU-R M.2319, equation A-3.6:

$$G_{RA,dB}(\theta) = -\frac{12}{(\theta_{3dB})^2} \theta^2 + G_{RA}, dBi$$

Equation 34

The parameters for this equation are shown below.

Table 98: Parameter for antenna pattern gain of RA (Set 1)

Frequency range	Peak gain and 3 dB BW	Cable loss
3.4 to 4.1 GHz	0 dBi, 60° 3 dB-BW	3 dB

This figure is derived for antenna pattern of RA from Report ITU-R M.2319, equation A-3.6:

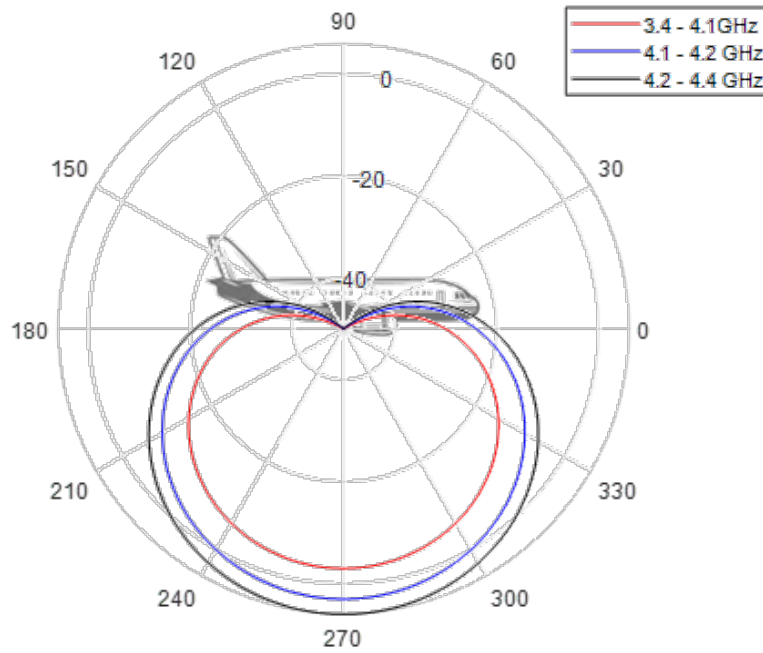

Figure 167: Antenna pattern gain of RA (dBi)

Altitude of RA is considered with two cases, 200 feet and 1000 feet.

This refers to section 4.3.

Table 99: UC 1 breakpoints between 3.4-3.8 GHz at 200 feet AGL in parameters Set 1, in dBm/MHz

Altimeter model	3.4-3.7 GHz	3.7-3.8 GHz	Source
F	-21 dBm/MHz	-30 dBm/MHz	AVSI Report Vol 3 Figure 9-9
L	NB	NB	AVSI Report Vol 3 Table 8-8
T	NB	NB	AVSI Report Vol 3 Table 6-6
X	NB	-21 dBm/MHz or NB with justification	AVSI Report Vol 3 Table 8-10
U	NB	NB	AVSI Report Vol 3 Table 6-9
Y	NDA	-29 dBm/MHz	AVSI Report Vol 1 Table 3-1 (Page 3-31)

Note: NB refers to No Breakpoint, meaning normal RA operation up to the maximum 5G signal level tested.
 Note: The thresholds are adjusted by 20 dB to convert from dBm/100MHz to dBm/MHz.
 Note: The thresholds incorporate cable loss for the wanted signal in the loop loss but do not account for cable loss for the interference signal and this needs to be considered appropriately.
 Note: NDA refers to "no data available," meaning testing was not conducted for the frequency range.

Table 100: UC 1 breakpoints between 3.4 to 3.8 GHz at 1000 feet AGL in parameters Set 1, in dBm/MHz

Altimeter model	3.4-3.7 GHz	3.7-3.8 GHz	Source
F	-24 dBm/MHz	-34 dBm/MHz	AVSI Report Vol 3 Figure 9-10
L	NB	NB	AVSI Report Vol 3 Table 8-13

Altimeter model	3.4-3.7 GHz	3.7-3.8 GHz	Source
T	NB	NB	AVSI Report Vol 3 Table 6-18
X	-24.3 or NB with justification	-36.5 or -24 dBm/MHz with justification	AVSI Report Vol 3 Table 8-14
U	NB	NB	AVSI Report Vol 3 Table 6-21
Y	NDA	-35 dBm/MHz	AVSI Report Vol 1 Table 3-1 (Page 3-31)
<p>Note: NB refers to No Breakpoint, meaning normal RA operation up to the maximum 5G signal level tested. Note: The thresholds are adjusted by 20 dB to convert from dBm/100MHz to dBm/MHz. Note: The thresholds incorporate cable loss for the wanted signal in the loop loss but do not account for cable loss for the interference signal and this needs to be considered appropriately. Note: NDA refers to "no data available," meaning testing was not conducted for the frequency range.</p>			

The interference tolerance threshold (ITT) can be converted from the provided breakpoints using the equation below:

$$ITT = BP - BTI_f - EE_f - U&T_f$$

Equation 35

where:

- *ITT*: The interference tolerance threshold at the input to the Radio Altimeter Transceiver/blue Receive Port. The interference tolerance threshold is defined for a specific altitude and frequency offset as the highest power for which performance is still acceptable (dBm/MHz);
- *BP*: The breakpoint of the altimeter (dBm/MHz);
- *BTI_f*: A *BP*-to-*ITT* backoff factor that accounts for the step-size used in the AVSI testing, 1 dB;
- *EE_f*: An experimental error factor, 1 dB;
- *U&T_f*: A unit-to-unit and temperature interference tolerance performance variation factor, 0dB for altimeter model F/L/X and 4dB for altimeter mobile T/U/Y.

Table 101: The interference tolerance threshold at the input to the Radio Altimeter Transceiver/Receive Port

Altimeter model	200 feet		1000 feet	
	3.4- 3.7 GHz	3.7-3.8 GHz	3.4-3.7 GHz	3.7-3.8 GHz
F	-23 dB	-32 dB	-26 dB	-36 dB
L	NB	NB	NB	NB
T	NB	NB	NB	NB
X	NB	-23 dB	-26.3dB	-38.5 dB
U	NB	NB	NB	NB
Y	NDA	-35 dB	NDA	-41 dB

A10.2 CALCULATION ON PEAK ANTENNA PATTERN GAIN OF BS BASED ON OPERATING ANGLE RANGE

BSs with AAS have variant gain patterns for antenna based on UE location, which means that the interference from BS to Radio Altimeter depends on the location of the serving UE. The serving angle of BS antenna is given in Table 12. Taking into account all serving angle in both horizontally and vertically, Figure 168 shows peak *e.i.r.p.* of BS AAS for all vertical elevation angle above horizon.

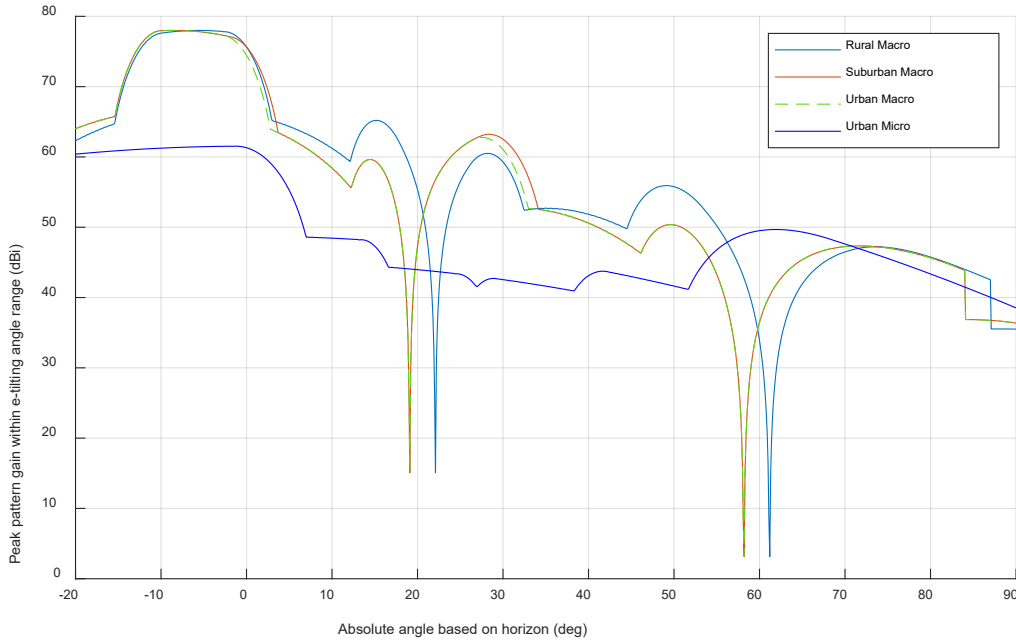

Figure 168: Enveloped *e.i.r.p.* of BS according to AAS configurations with and without subarray

A10.3 METHODOLOGY OF CALCULATION ON RECEIVING INTERFERENCE LEVEL OF BS IN RADIO ALTIMETER

The configuration for calculating interference level from BS at receiver of RA is described below.

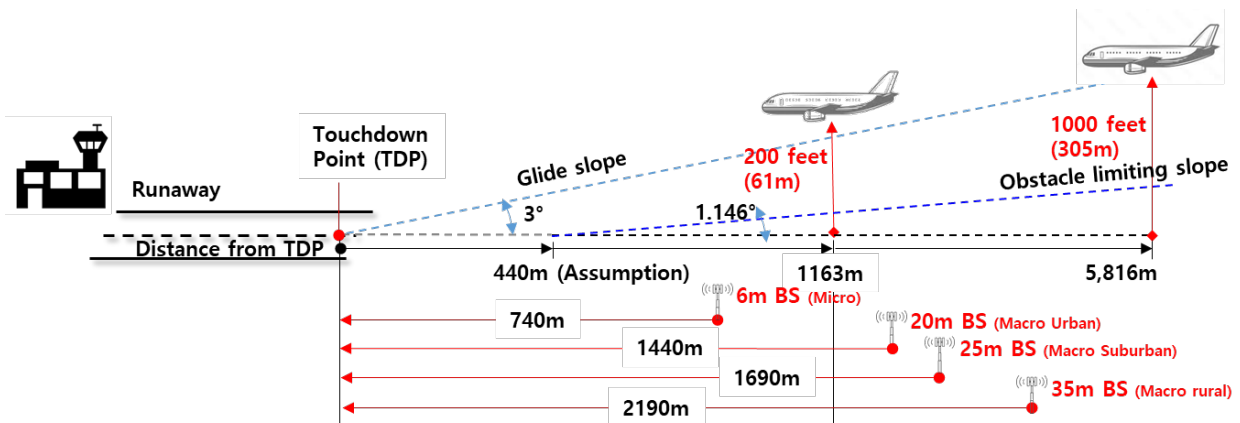

Figure 169: Configuration for BS and RA for calculation of receiving interference level

Based on the obstacle limitation slope near the airport, there is a restriction to deploy BS from the touch down point of the aircraft to according to the heights of the BS

Table 102: Minimum distance to deploy BSs from touch down point, as a function of the BS height

Height of BS	Min. distance to deploy BS from touch down point
6 m	740 m
20 m	1440 m
25 m	1690 m
35 m	2190 m

When an aircraft takes off or lands at the airport, two cases are taken, 200 feet (61 m) and 1000 feet (304.8 m) altitudes of the aircraft above the ground. This analysis does not consider the Obstacle Limitation Surface (OLS) not to be able to deploy BS in a certain height.

Based on those configurations, the receive interference level for the Radio Altimeter for each altitude would be calculated.

$$I_{Rx}^{RA} = P_{TRP}^{BS} + G_{ant\ to\ RA}^{BS}(\theta, \varphi) - PL_{Free\ space} + G_{ant\ to\ BS}^{RA}(\emptyset) - L_{cable}^{RA}$$

Equation 36

Where

- I_{Rx}^{RA} : Interference level from BS to RA receiver;
- P_{TRP}^{BS} : Power level of BS (TRP);
- $G_{ant\ to\ RA}^{BS}(\theta, \varphi)$: Peak antenna gain of BS to RA (θ, φ : vertical and azimuth angle to RA);
- $PL_{Free\ space}$: Path loss (free space loss: $32.44 + 20 \log_{10} \frac{carrier\ frequency}{distance\ between\ BS\ and\ RA}$);
- $G_{ant\ to\ BS}^{RA}(\emptyset)$: Antenna pattern gain of RA to BS (\emptyset : angle between RA main-beam and BS);
- L_{cable}^{RA} : Cable loss of RA, 3 dB.

In the calculation, the measuring point for receiving interference level of RA is set in 2D, which means that RA in the altitudes of 200 and 1000 feet is located in x distance and y distance from BS. Reversely, BS is located in -x distance and -y distance from RA.

A10.4 CALCULATION OF PEAK INTERFERENCE LEVEL FROM MFCN BS

A10.4.1 Macro BS (AAS with subarray)

Ground distance of x-axis is based on a touch down point of 0 m.

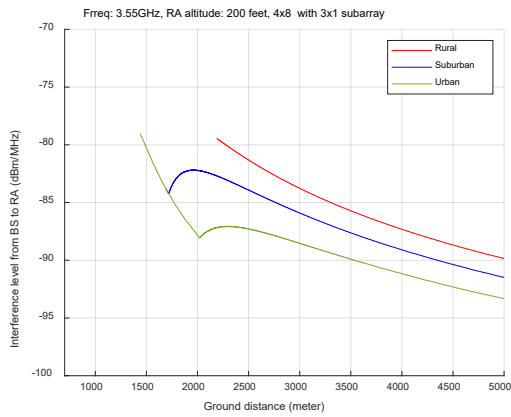

200 feet of RA

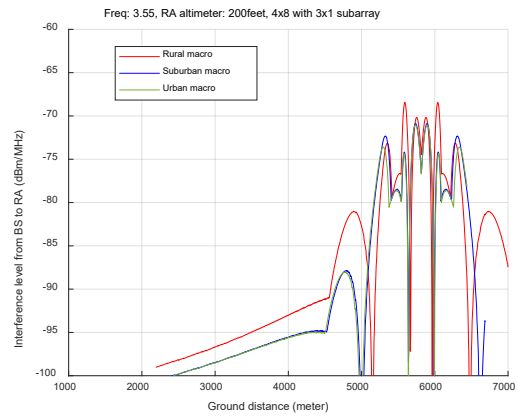

(b) 1000 feet of RA

Figure 170: Interference levels from BSs to RA

A10.4.2 Summary of calculation result

Table 103 summarises the peak receiving interference level at RA from AAS BS with subarray for possible deployment location of BS near airport.

Table 103: Summary of Peak receiving interference levels from MFCN BS

Altitude	Freq. bands	Rural Macro	Suburban Macro	Urban Macro
200 feet	3.4-3.7 GHz	-79.5 dBm/100 MHz @ $\Delta x = 2190$ m	-82.2 dBm/100 MHz @ $\Delta x = 1940$ m	-79.0 dBm/100 MHz @ $\Delta x = 1440$ m
	3.7-3.8 GHz	-79.9 dBm/100 MHz @ 2190 m	-82.7 dBm/100 MHz @ $\Delta x = 1940$ m	-79.5 dBm/100 MHz @ $\Delta x = 1440$ m
1000 feet	3.4-3.7 GHz	-68.4 dBm/100 MHz @ $\Delta x = 5590$ m	-70.9 dBm/100 MHz @ $\Delta x = 5895$ m	-71.0 dBm/100 MHz @ $\Delta x = 5895$ m
	3.7-3.8 GHz	-68.9 dBm/100 MHz @ $\Delta x = 5590$ m	-71.3 dBm/100 MHz @ $\Delta x = 5895$ m	-71.5 dBm/100 MHz @ $\Delta x = 5895$ m

Δx is a distance from the touchdown point of the aircraft to where the BS causes the highest interference to the Radio Altimeter at the given altitude.

The margins with the peak interference levels are calculated for two deployment scenarios and compared with the maximum interference threshold levels of the RA models, which are shown in Table 104. All cases have positive margin, several tens of dB.

Table 104: Margin (dB) which AAS BS with subarray does not exceed Maximum interference threshold of RA models

Altimeter model	200 feet (Rural/Suburban/Urban)		1000 feet (Rural/Suburban/Urban)	
	3.4-3.7 GHz	3.7-3.8 GHz	3.4-3.7 GHz	3.7-3.8 GHz
F	56.5 / 59.2 / 56.0	56.9 / 59.7 / 56.5	36.4 / 38.9 / 39.0	36.9 / 39.3 / 39.5
L	NB	NB	NB	NB
T	NB	NB	NB	NB
X	NB	56.9 / 59.7 / 56.5	42.1 / 44.6 / 44.7	30.4 / 32.8 / 33.0
U	NB	NB	NB	NB
Y	NDA	44.9 / 47.7 / 44.5	NDA	27.9 / 30.3 / 30.5

A10.5 CONCLUSION

This study derives the peak EIRP values of BSs above the horizon taking into account the characteristics and deployment of BS under the assumptions of the IMT-related WRC-19 agenda item 1.2 on IMT identification under assumption of 78 dBm/100MHz EIRP of MFCN BS. With this peak EIRP value of BS, the peak interference level from MFCN BS with AAS beamforming with subarray to RA (including RA antenna gain) are provided at 200 feet and 1000 feet of RA altitude. For the base station locations and operational scenarios studied, the margin to the interference tolerance thresholds of RA result in positive values (no interference from BS to RA), more than 44.5dB (Urban macro) and 27.9 dB (Rural macro) for 200 feet and 1000 feet of RA altitude, respectively.

ANNEX 11: (STUDY J) CALCULATION OF PEAK RECEIVING INTERFERENCE LEVEL IN RADIO ALTIMETER FROM WBB LMP OPERATING IN THE FREQUENCY BAND 3.8-4.2 GHZ TO RA ANTENNA AT ALTITUDES OF 200 FEET AND 1000 FEET WITH SET1 PARAMETERS

A11.1 SYSTEM CHARACTERISTICS FOR STUDIES

A11.1.1 WBB LMP

The parameters of WBB LMP refer to 0 which is also based on WP 5D assumptions for IMT-related WRC-19 agenda item 1.2 on IMT identification.

A11.1.1.1 Base station characteristics for each deployment type

The BS characteristics refer to the assumption in WRC-19 Agenda item 1.2 for IMT identification, for the frequency range 3.8-4.2 GHz. The MCFN base stations in the 3.4-3.8 GHz band are established for four deployment types: Rural, Urban, Suburban Macro and Urban Micro. But Indoor cells are not considered.

In addition, the WBB base stations in the 3.8-4.2 GHz band needs to be considered as low and medium power (LMP) so that the TRP would be adjusted to meet medium power (i.e. 51 dBm/100 MHz *e.i.r.p.*). In case of the airport location environment, the macro environment deployment scenarios are mainly considered near the airport.

Table 105: Base station characteristics in MCFN and WBB LMP bands from WP 5D assumption for WRC-19

Parameter	WBB LMP 3.8-4.2 GHz		
Deployment type	Medium Power		
Bandwidth BW (MHz)	100		
<i>e.i.r.p.</i> at boresight (dBm)	51		
Deployment scenarios	Suburban macro	Urban macro	Micro
Cell radius (km) (Absolute angle to serve cell edge)	0.8 (91.8°)	0.4 (92.9°)	0.2 (Note 6) (91.7°)
Antenna height h_{AAS} (m)	25	20	6
AAS model	4x8 (3x1 SubA)		8x8 (No SubA)
Mechanical downtilt (degrees)	6		10
horizontal coverage range (degrees)	$\pm 60^\circ$ ($\varphi_{coverage} = 60^\circ$)		
vertical coverage range (degrees) (Note 1 and Note 2)	90° to 100° (Note 3) ($\theta_{coverage} = 10^\circ$)		90° to 120° (Note 3) ($\theta_{coverage} = 30^\circ$)
Note 1: The vertical coverage is given in global coordinate system, i.e. 90° being horizon. Note 2: The vertical coverage includes the mechanical downtilt. Note 3: There currently no regulation limiting the AAS pointing direction above the horizon, so cases where the vertical coverage angles are lower than 90° (above the horizon) must be considered as well.			

The OOB of BS in the adjacent band 4.2-4.4 GHz is assumed to be 4 dBm/MHz *e.i.r.p.* the most conservative case (i.e. no guard band). It is tentatively translated to TPR minus peak antenna gain of AAS BS.

Table 106: Baseline and transitional power limits for synchronised MFCN networks, for non-AAS and AAS base stations

BEM element	Frequency range	Non-AAS <i>e.i.r.p.</i> limit dBm/(5 MHz) per antenna	AAS TRP limit dBm/(5 MHz) per cell (Note1)
Transitional region	-5 to 0 MHz offset from lower block edge 0 to 5 MHz offset from upper block edge	Min($P_{Max}-40, 21$) (Note 2 and Note 3)	Min($P_{Max}'-40, 16$) (Note 2 and Note 4)
Transitional region	-10 to -5 MHz offset from lower block edge 5 to 10 MHz offset from upper block edge	Min($P_{Max}-43, 15$) (Note 2 and Note 3)	Min($P_{Max}'-43, 12$) (Note 2 and Note 4)
Baseline	Below -10 MHz offset from lower block edge. Above 10 MHz offset from upper block edge. Within 3400-3800 MHz.	Min($P_{Max}-43, 13$) (Note 2 and Note 3)	Min($P_{Max}'-43, 1$) (Note 2 and Note 4)

Note: for TDD blocks the transitional region applies in case of synchronised adjacent blocks, and in-between adjacent TDD blocks that are separated by 5 or 10 MHz. The transition region does not extend below 3400 MHz or above 3800 MHz.
 Note 1: In a multi-sector base station, the radiated power limit applies to each one of the individual sectors.
 Note 2: The transitional regions and the baseline power limits apply to the synchronised operation of MFCN networks as defined in ECC Report 281.
 Note 3: P_{Max} is the maximum mean carrier power in dBm for the base station measured as *e.i.r.p.* per carrier, interpreted as per antenna
 Note 4: P_{Max}' is the maximum mean carrier power in dBm for the base station measured as TRP per carrier in a given cell.

A11.1.1.2 Beamforming AAS characteristics

The AAS models and parameters are taken into account based on WP 5D assumptions for WRC-19 Sharing study with IMT and other services. The AAS models have specifically two different types, with sub-array (SA) and without sub-array (no SA). As generally expected, deployment of BS near airport, the AAS with sub-array would be mainly considered.

Table 107: Key parameters for Beamforming AAS characteristics for IMT in 1710-4990 MHz

Parameter	With Sub-array (SA)	No sub-array (No SA)
Max gain (Note 1)	26.2 dBi	24.5 dBi
Element gain (dBi) (Note 1)	6.4	6.4
Antenna array configuration (Row × Column), (Note 2)	4 x 8	8x8
Number of element rows in sub-array,	3	N.A.
Pre-set sub-array down-tilt, θ subtilt (degrees)	3	N.A.

Note 1: The element gain includes the ohmic loss (2 dB) and is per polarisation. This means that this ohmic loss parameter is not needed for the calculation of the BS composite antenna gain and *e.i.r.p.*
 Note 2: For the small/micro cell case, 8 × 8 means there are 8 vertical and 8 horizontal radiating elements. For the extended AAS model case, 4 × 8 means there are 4 vertical and 8 horizontal radiating sub-arrays.

A11.1.2 Radio Altimeter

Antenna patter gain of Radio Altimeter is applied with the same Report ITU-R M.2319, , equation A-3.6.

$$G_{RA,dB}(\varnothing) = -\frac{12}{(\varnothing_{3dB})^2} \varnothing^2 + G_{RA}, dBi$$

Equation 37

The parameters for this equation are shown below.

Table 108: Parameter for antenna pattern gain of RA (Set 1)

Frequency range	Peak gain and 3 dB BW	Cable loss
3.4-4.1 GHz	0 dBi, 60° 3 dB-BW	3 dB
4.1-4.2 GHz	6 dBi, 60° 3 dB-BW	3 dB
4.2-4.4 GHz	9 dBi, 60° 3 dB-BW	3 dB

This figure is derived for antenna pattern of RA from Report ITU-R M.2319, equation A-3.6.

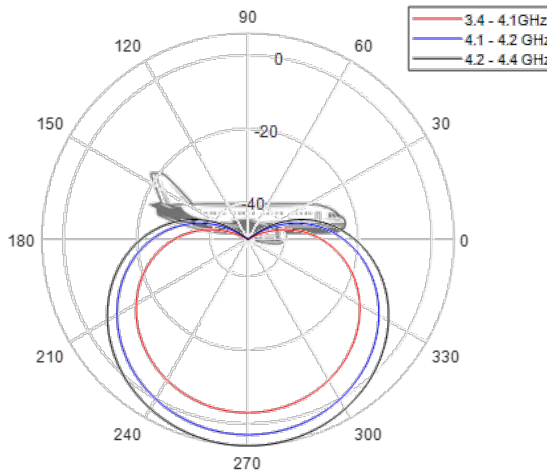

Figure 171: Antenna pattern gain of RA (dBi)

Altitude of RA is considered with two cases, 200 feet and 1000 feet.

This refers to section 4.3:

Table 109: Breakpoint values and maximum interference levels for altimeter model of set 1, in dBm/MHz

Model	200 feet			1000 feet		
	3.8-4.1 GHz	4.1-4.2 GHz	4.1-4.2 GHz	3.8-4.1 GHz	4.1-4.2 GHz	4.1-4.2 GHz
F	-35	-31	-67	-40	-37	-79
L	-8	-	-79	-7	-	-79.9
T	NB	NB	-60.8	-30.9	-33.8	-65.8
X	-28	-	-61.1	-36	-	-91.5
U	NB	NB	-80.8	NB	NB	-90.8
Y	-28	-	-64	-37	-	-78

An interference tolerance threshold (ITT) can be converted from the provided breakpoints using below equation 1

$$ITT = BP - BTI_f - EE_f - U\&T_f$$

Where:

- *ITT*: The interference tolerance threshold at the input to the Radio Altimeter Transceiver/blue Receive Port. The interference tolerance threshold is defined for a specific altitude and frequency offset as the highest power for which performance is still acceptable (dBm/MHz);
- *BP*: The breakpoint of the altimeter (dBm/MHz);
- *BTI_f*: A *BP*-to-*ITT* backoff factor that accounts for the step-size used in the AVSI testing, 1 dB;
- *EE_f*: An experimental error factor, 1 dB;
- *U&T_f*: A unit-to-unit and temperature interference tolerance performance variation factor, 0 dB for altimeter model F/L/X and 4 dB for altimeter mobile T/U/Y.

Table 110: The interference tolerance threshold at the input to the Radio Altimeter Transceiver/Receive Port in dBm/MHz

Model	200 feet			1000 feet		
	3.8-4.1 GHz	4.1-4.2 GHz	4.1-4.2 GHz	3.8-4.1 GHz	4.1-4.2 GHz	4.1-4.2 GHz
F	-37	-33	-73	-42	-39	-85
L	-10	-	-81	-9	-	-81
T	-	-	-66.8	-36.9	-39.8	-71.8
X	-30	-	-63.8	-38	-	-83.2
U	-	-	-	-	-	-
Y	-34	-	-70	-43	-	-84

A11.2 CALCULATION ON PEAK ANTENNA PATTERN GAIN OF BS BASED ON OPERATING ANGLE RANGE

BSs with AAS have an antenna gain pattern based on UE location, which means that the interference from BS to Radio Altimeter depends on the location of the serving UE. The serving angle of BS antenna is given in Table 12. Taking into account all serving angles in both horizontally and vertically, Figure 172 shows peak *e.i.r.p.* of BS AAS for all vertical elevation angles above horizon.

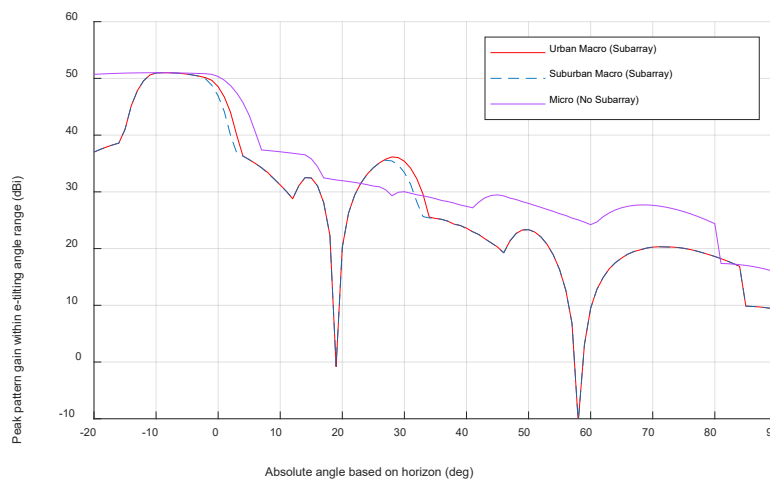

Figure 172: Enveloped *e.i.r.p.* of BS according to AAS configurations with and without subarray

A11.3 METHODOLOGY OF CALCULATION ON RECEIVING INTERFERENCE LEVEL OF BS IN RADIO ALTIMETER

The configuration for calculating interference level from BS at receiver of RA is described below.

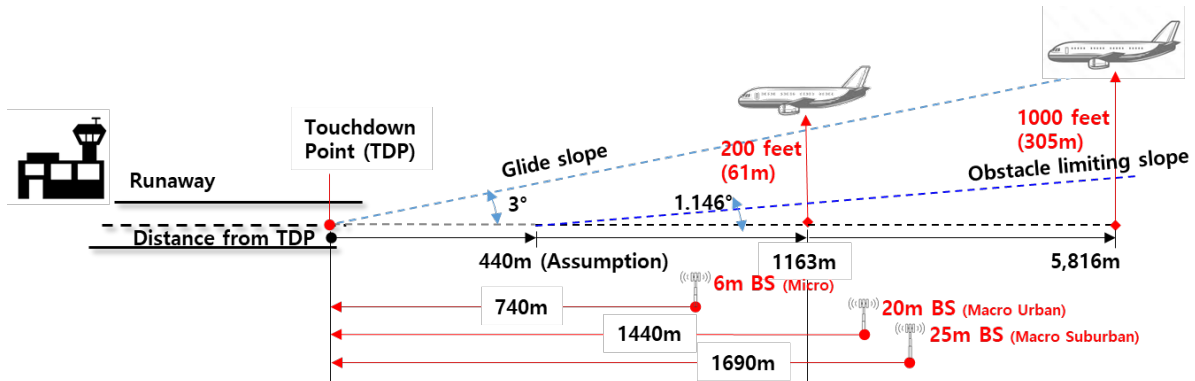

Figure 173: Configuration for BS and RA for calculation of receiving interference level

When an aircraft takes off or lands at the airport, two cases are considered, 200 feet (70 m) and 1000 feet (304.8 m) altitudes of aircraft above ground. This analysis does not consider the Obstacle Limitation Surface (OLS) not to be able to deploy BS in a certain height.

Based on those configurations, the receiving interference level in Radio Altimeter for each altitude would be calculated:

$$I_{Rx}^{RA} = P_{TRP}^{BS} + G_{ant\ to\ RA}^{BS}(\theta, \varphi) - PL_{Free\ space} + G_{ant\ to\ BS}^{RA}(\phi) - L_{cable}^{RA} - L_{polarization}^{RA}$$

Equation 38

Where:

- I_{Rx}^{RA} : Interference level from BS to RA receiver;
- P_{TRP}^{BS} : Power level of BS (TRP);
- $G_{ant\ to\ RA}^{BS}(\theta, \varphi)$: Peak antenna gain of BS to RA (θ, φ : vertical and azimuth angle to RA);
- $PL_{Free\ space}$: Path loss (free space loss: $32.44 + 20 \log_{10} \frac{carrier\ frequency}{distance\ between\ BS\ and\ RA}$);
- $G_{ant\ to\ BS}^{RA}(\phi)$: Antenna pattern gain of RA to BS (ϕ : angle between RA main-beam and BS);
- L_{cable}^{RA} : Cable loss of RA, 3 dB;
- $L_{polarization}^{RA}$: Polarisation loss between RA and IMT BS, 1.5 dB.

In the calculation, the measuring point for receiving interference level of RA is set in 2D, which means that RA at the altitudes of 200 and 1000 feet is located in x distance and y distance from BS. Reversely, BS is located in -x distance and -y distance from RA.

A11.4 CALCULATION OF PEAK INTERFERENCE LEVEL FROM WBB LMP BS

The interference levels at RA from MFCN BS are calculated for some deployment scenarios according to distance of BS deployment from touch down point. Finally, this chapter provides the margin of interference from MFCN BS based on the maximum interference tolerance level for RA.

A11.4.1 Macro BS (AAS with subarray)

Ground distance of x-axis is based on touch down point where is 0 meter.

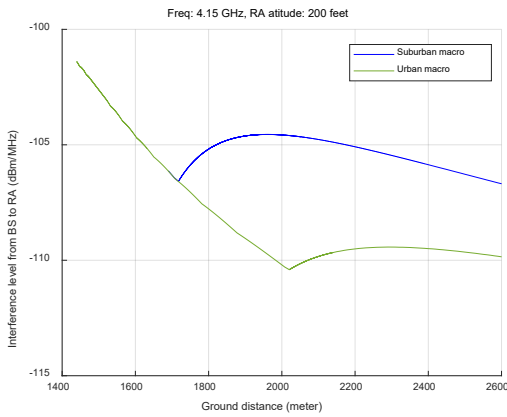

(a) 200 feet

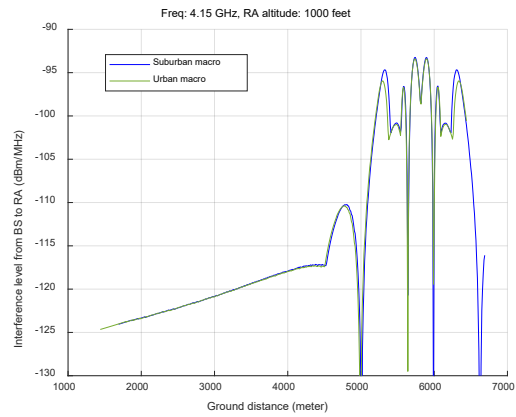

(b) 1000 feet

Figure 174: Peak interference level of AAS BS with subarray to RA according to distance between BS and RA

A11.4.2 Summary of calculation result

Table 111 summarises the peak receiving interference level at RA from AAS BS with subarray for possible deployment location of BS near airport.

Table 111: Summary of Peak receiving interference levels from WBB LMP of BS

Altitude	Freq. bands	Suburban Macro	Urban Macro
200 feet	4.0-4.1 GHz	-110.3 dBm/100-MHz @ $\Delta x = 1961$ m	-107.2 dBm/100 MHz @ $\Delta x = 1440$ m
	4.1-4.2 GHz	-104.5 dBm/100 MHz @ $\Delta x = 1961$ m	-101.4 dBm/100 MHz @ $\Delta x = 1440$ m
	4.2-4.4 GHz (OOBE)	-128.1 dBm/100 MHz @ $\Delta x = 1961$ m	-125.0 dBm/100 MHz @ $\Delta x = 1440$ m
1000 feet	4.0-4.1 GHz	-99.0 dBm/100 MHz @ $\Delta x = 5740$ m	-99.2 dBm/100 MHz @ $\Delta x = 5740$ m
	4.1-4.2 GHz	-93.2 dBm/100 MHz @ $\Delta x = 5740$ m	-93.4 dBm/100 MHz @ $\Delta x = 5740$ m
	4.2-4.3 GHz (OOBE)	-116.8 dBm/100 MHz @ $\Delta x = 5740$ m	-117.0 dBm/100 MHz @ $\Delta x = 5740$ m

Δx is the distance from touch down point (TDP) of the aircraft to BS, where BS causes the highest interference to Radio Altimeter in the given altitude.

The margins with the peak interference levels are calculated for two deployment scenarios with comparing the maximum interference threshold levels of the RA models, which is shown in Table 112.

Table 112: Margin which AAS BS with subarray does not exceed Maximum interference threshold of RA models by in-band and out of band emission of BS

Model	200 feet (Suburban / Urban)			1000 feet (Suburban / Urban)		
	4.0-4.1 GHz	4.1-4.2 GHz	4.2-4.3 GHz	4.0-4.1 GHz	4.1-4.2 GHz	4.2-4.3 GHz
	Blocking effect of RA		Oobe effect	Blocking effect of RA		Oobe effect
F	73.3 / 70.2	71.5 / 68.4	55.1 / 52.0	57.0 / 57.2	54.4 / 54.4	31.8 / 32.0
L	100.3 / 97.2		47.1 / 44.0	90.0 / 90.2		35.8 / 36.0
T			61.3 / 58.2	62.1 / 62.3	53.4 / 53.6	45.0 / 45.2
X	80.3 / 77.2		64.3 / 61.2	61.0 / 61.2	-	33.6 / 33.8
U						
Y	76.3 / 73.2		58.1 / 55.0	56.0 / 56.2		32.8 / 33.0

All cases have a large positive margin, several tens of dB. In detail, the critical interference effects by blocking performance of RA as the lowest margin are 70.2 dB for RA Model F in Urban macro at 200 feet and 53.4 dB for RA Model T in Suburban macro at 1000 feet. The highest interference effects by unwanted emission (OOBE) of BS are 44.0 dB for RA Model L at 200 feet in Urban macro and 31.8 dB for RA Model F in Suburban macro at 1000 feet

A11.5 CONCLUSION

This study derives the peak *e.i.r.p.* values of BS above the horizon taking into account the characteristics and deployment of BS in the assumptions of the IMT-related WRC-19 agenda item based on the medium power of MFCN BS (i.e. 51 dBm/100 MHz). With this peak *e.i.r.p.* value of BS, the peak interference level from WBB LMP BS applying AAS beamforming with subarray to RA (including RA antenna gain) are provided at 200 feet and 1000 feet of RA altitude. For the base station locations and operational scenarios studied, the margin not to exceed interference tolerance thresholds of RA result in large positive values (no interference from BS to RA) such as several tens of dB. Based on Interference Tolerance Threshold by measuring for given RA models, the lowest margins from interference by blocking effect of RA are 70.2 dB at 200 feet of RA altitude and 53.4 dB at 1000 feet of RA altitude. In addition, the lowest margins from interference by unwanted emission (OOBE) of BS are 44.0 dB at 200 feet of RA altitude and 31.8 dB at 1000 feet of RA altitude.

ANNEX 12: (STUDY K) RADIO ALTIMETERS AND DECT-2020 NR COEXISTENCE STUDY WITH SET2 PARAMETERS

A12.1 INTRODUCTION TO DECT-2020 NR

A12.1.1 Overview

DECT-2020 NR is an IMT-2020 technology as defined in Recommendation ITU-R M.2150: "Detailed specifications of the terrestrial radio interfaces of International Mobile Telecommunications-2020 (IMT-2020)" [43], and a candidate technology for wireless broadband low/medium power (WBB LMP) connectivity in the 3.8-4.2 GHz band.

Medium power operation is not envisioned for DECT-2020 NR, therefore only 'low power' is considered in these studies. The e.i.r.p of DECT-2020 NR is 23 dBm (assuming a 0 dBi antenna) for the current bandwidth options of 1.728, 3.456 and 6.912 MHz. If wider area coverage is needed, additional DECT-2020 NR devices can be deployed within a self-organising mesh network rather than increasing the output power (and the consequential increase in possible interference to other users). For these studies, only the bandwidth option of 6.912 MHz is included on the assumption that narrower bandwidths would improve coexistence, particularly with adjacent channel applications.

Within a DECT-2020 NR network all radio devices comply with a single standard, i.e. there is not a separate standard for 'base stations' and 'terminals/UEs' as there are in other technologies such as 3GPP. Radio devices can have the following roles based on their location and requirements in the network:

- Sink node: this is the gateway between the back-end network and the DECT-2020 NR cluster(s), for example the gateway to the internet or local back-end. The sink node is always a fixed terminal radio device, i.e. Radio Device Fixed Termination Point (RD_{FT});
- Leaf node: the end point of the network and can only send and/or receive data. A leaf node is Radio Device Portable Termination Point (RD_{PT}) device;
- Router node: extends the network by routing messages to other devices or clusters. The router node operates as RD_{FT} role for its cluster members, and it operates as a RD_{PT} role in the next cluster heading to a sink node (RD_{FTPT}).

For the purposes of this input, the sink node can be considered the 'base station' and all other devices can be considered 'terminals'.

For DECT-2020 NR, the requirement for transmitter power control (TPC) is specified within the standard (ETSI TS 103 636-4 DECT-2020 New Radio (NR); part 4: MAC layer) and defines the TPC power range from -40 dBm to maximum e.i.r.p. (23 dBm). The standard, and the requirement for TPC, applies to all devices within a DECT-2020 NR network.

Within a DECT-2020 NR network, each device is only looking to communicate with its neighbour for the 'next hop' and is not looking to communicate over a cell in the way other technologies do. Communication with a distant terminal is achieved via a series of hops between the sink, via router nodes to the leaf, and only one device within the network transmits at any given time. Each device employs TPC to operate with the minimum power to achieve connection with its neighbour. Consequently, the average radio device transmit power is much lower than the maximum transmitter output power, and the average out-of-band emission (OOBE) level would be much lower than the specified OOBE level. This is an inherent feature of the automatic interference management capability of DECT-2020 NR to reduce transmitted power and therefore reduce the risk of interference to other users.

A12.2 TECHNICAL PARAMETERS

A12.2.1 DECT-2020 NR

Table 113 summarises the technical parameters of DECT-2020 NR used in this study. These parameters are taken from the ETSI TS 103 636-2 v1.4.1 [39]²², with modified noise figures due to higher frequencies. Table 113 provides values for three bandwidths, however, this study only considers the bandwidth option of 6.912 MHz.

Table 113: Parameters of DECT-2020 NR providing local network connectivity in the 3.8-4.2 GHz band

Parameter	Value		
	1.728	3.456	6.912
Nominal channel bandwidth (MHz)	1.728	3.456	6.912
Transmission channel bandwidth (MHz)	1.539	3.051	6.075
Transmitter power (dBm)	23	23	23
Antenna gain	0 dBi		
Antenna height	Outdoor: Limited to a maximum of 10 m above ground Indoor: Any height within building		
Noise figure (dB)	9	9	9
Rx indoor receiving level	20 dBm to reference sensitivity		
Rx outdoor receiving level	20 dBm to reference sensitivity		
Rx sensitivity (dBm)	-97.7	-94.7	-91.7
Protection criteria	5 dB S/N+I		

A12.2.1.1 Transmitter spectrum emission requirements

Out of band emissions

The spectrum emission mask of the device applies to frequencies (Δf_{OOB}) starting from the \pm edge of the assigned WBB LMP channel. For frequency offsets greater than Δf_{OOB} the spurious emission limits apply (see Table 114).

Table 114: Spectrum emission limit for 6.912 MHz channel bandwidth

Spectrum emission limit (dBm)		
Δf_{OOB} /MHz	6.912 MHz channel bandwidth	Measurement bandwidth
± 0 to 0.4185	-10	30 kHz
± 0.4185 to 6.4935	-10	1 MHz
± 6.4935 to 7.3305	-13	1 MHz
± 7.3305 to 13.4055	-20	1 MHz
± 13.4055 to 13.824	-23	1 MHz

Spurious emissions

The spurious emission limits apply for the frequency ranges that are more than Δf_{OOB} (MHz) in Table 115 from the edge of the channel bandwidth.

²² The Technical Specification has been updated to ETSI TS 103 636-2 V1.5.1 (2024-03) [40] with improved out of band emission. However, to maintain consistency with ECC Report 358 the values are taken from ETSI TS 103 636-2 v1.4.1

Table 115: Spurious emission limits

Spurious emission limit (dBm)		
Frequency Range	Maximum Level	Measurement bandwidth
9 kHz ≤ f < 150 kHz	-36	1 kHz
150 kHz ≤ f < 30 MHz	-36	10 kHz
30 MHz ≤ f < 1000 MHz	-36	100 kHz
1 GHz ≤ f < 12.75 GHz	-30	1 MHz
12.75 GHz ≤ f < 5th harmonic of the upper frequency edge in GHz	-30	1 MHz

A12.2.2 Radio Altimeter parameters

A12.2.2.1 Interference tolerance threshold (Parameter Set 2)

Table 116: ITT values for Parameter Set 2

Frequency band (GHz)	200 feet (dBm/MHz)	1000 feet (dBm/MHz)	Source
3.8-4.1	-42	-48	Vol AVSI. I; Table 3-1, Altimeter F @3930 MHz
4.1-4.2	-42	-48	
4.2-4.4	-76	-85	AVSI Report Vol 2 Table 4-2, 200 feet: Altimeter L, 1000 feet: Altimeter F.

A12.2.2.2 Antenna radiation pattern

Table 117: Antenna model for Parameter Set 2

Frequency Range (GHz)	3.8-4.1	4.1-4.2	4.2-4.4
Antenna Gain $G_{RA,max}$ (dBi)	3	8	10
	Antenna pattern: Omni incl. cable loss	Antenna pattern: Report ITU-R M.2319 (A-3.6 with $\Delta\theta_{3dB} = 60^\circ$ at 3 dB) And 3 dB cable loss	Antenna pattern: Report ITU-R M.2319 (A-3.6 with $\Delta\theta_{3dB} = 60^\circ$ at 3 dB) and 3 dB cable loss

A12.3 DECT-2020 NR STUDY

This study assumes a maximum *e.i.r.p.* of 23 dBm and bandwidth of 6.912 MHz for DECT-2020 NR. Only the line of sight is considered. Therefore, the free-path loss channel propagation model in Recommendation ITU-R P.452 is used. No antenna discrimination between DECT-2020 NR and the Radio Altimeter is assumed, and therefore the maximum RA antenna gain from Table 117 is used.

A bandwidth correction factor of 8.4 dB is applied to the interference tolerance thresholds in Table 116 for the DECT-2020 NR bandwidth of 6.912 MHz.

A12.3.1 In-band study

Interference Power (IP) = $e.i.r.p._{DECT} + RA_{ANT\ GAIN} - \text{Cable Loss} - \text{Path Loss}$ (with D = 200 feet and D = 1000 feet)

For the sub-band 3.8-4.1 GHz the DECT-2020 NR frequency is 3950 MHz, and for 4.1-4.2 GHz it is 4150 MHz.

Table 118: In-band coexistence results

Frequency band (GHz)	ITT @ 200 feet (dBm/6.912 MHz)	ITT @ 1000 feet (dBm/ 6.912 MHz)	RA Antenna Gain (dB)	RA cable loss (dB)	IP (dBm) @ 200'	IP (dBm) @ 1000'
3.8-4.1	-33.6	-39.6	3	0	-54.1	-68.1
4.1-4.2	-33.6	-39.6	8	3	-52.5	-66.5

As can be seen in Table 118, for each breakpoint the interference power is below the ITT, with a margin between 18.9 dB and 28.5 dB which exceed the required 6 dB safety margin as recommended by ICAO. It is highlighted that this is a minimum coupling loss analysis assuming DECT-2020 NR is operating in the worst-case geometry with RA at 200 feet and 1000 feet, and at full power with no antenna discrimination.

A12.3.2 Adjacent band study

On the assumption that DECT-2020 NR operates immediately adjacent to the 4.2 GHz boundary, all the OOB power will fall in-band to the RA.

Integrating the OOB power from $\Delta f_{OOB} = 0$ MHz to 13.824 MHz, and the spurious power from 13.824 MHz to 160 MHz gives a total (maximum) interfering power of 3.53 dBm/160 MHz, or -18.51 dBm/MHz. The DECT-2020 NR frequency is assumed to be 4196.544 MHz.

Interference Power OOB (IP_{OOB}) = $e.i.r.p._{DECT\ OOB} (-18.51\ \text{dBm/MHz}) + RA_{ANT\ GAIN} - \text{Cable Loss} - \text{Path Loss}$ (with D = 200' and D = 1000')

Table 119: Adjacent channel coexistence results

Frequency band (GHz)	ITT @ 200ft (dBm/MHz)	ITT @ 1000 feet (dBm/MHz)	RA Antenna Gain (dB)	RA cable loss (dB)	IP_{OOB} (dBm) @ 200'	IP_{OOB} (dBm) @ 1000'
4.2-4.4	-76	-85	10	3	-92.11	-106.11

A12.4 SUMMARY OF RESULTS

As it can be seen in Table 118, for each breakpoint the interference power is below the ITT. It is highlighted that this is a minimum coupling loss analysis with 0 dBi antenna gain in any direction between the DECT-2020 NR device and the RA antennas assumed, i.e. the full output power of DECT is within the maximum antenna gain of the RA receive antenna.

Similarly, for the adjacent channel scenario, assuming no frequency separation between DECT-2020 NR and Radio Altimeters, for the base station locations and operational scenarios studied, there is a margin of 16.11 to 21.11 dB between the ITT and unwanted emissions from DECT-2020 NR which is above the 6 dB safety margin recommended by ICAO.

ANNEX 13: (STUDY L) COEXISTENCE ANALYSIS BETWEEN MFCN IN 3.4-3.8 GHZ AND RADIO ALTIMETER IN 4.2-4.4 GHZ BAND

A13.1 INTRODUCTION

This study analyses the compatibility between MFCN operating in 3400-3800 MHz and Radio Altimeters (RA) operating in 4200-4400 MHz. In this Annex, the interference level from MFCN base stations to altimeters is analysed by worst case, which the maximum output power (e.i.r.p) of 78 dBm/100 MHz is considered and its boresight is pointing directly towards RA. Through calculating the maximum sidelobe effect of MFCN BS antenna, the result of interference level shows the sharing between MFCN BS and altimeter is no risk for both 200 and 1000 feet height. If the average sidelobe antenna gain which is more in line with actual situation has taken into account, the margin could be more improved.

A13.2 TECHNICAL CHARACTERISTICS

A13.2.1 MFCN parameters

The MFCN deployment and antenna parameters used in this study are shown in Table 120, three macro scenarios urban/suburban/rural are considered. The maximum e.i.r.p. of 78 dBm/100 MHz is a typical value of MFCN BS deployed in Europe.

Table 120: Base station parameters in 3.4-3.8GHz MFCN

	Rural macro	Urban macro	Suburban macro
Base station characteristics/Cell structure			
Cell radius	1.6 km	0.4 km	0.8 km
Antenna height	35 m	20 m	25 m
Sectorisation	3 sectors	3 sectors	3 sectors
Maximum e.i.r.p.	78 dBm	78 dBm	78 dBm
Channel bandwidth	100 MHz	100 MHz	100 MHz
Base station antenna characteristics			
Antenna pattern (dBi)	Sub-array Extended AAS Model 3GPP TR 38.803 , section 5.2.3.2.4		
Element gain (dBi) (Note 1)	6.4	6.4	6.4
Horizontal/vertical 3 dB beam width of single element (degree)	90° for H 65° for V	90° for H 65° for V	90° for H 65° for V
Horizontal/vertical front-to-back ratio (dB)	30 for both H/V	30 for both H/V	30 for both H/V
Antenna polarisation	Linear ±45°	Linear ±45°	Linear ±45°
Antenna array configuration (Row × Column) (Note 2)	4 × 8 elements	4 × 8 elements	4 × 8 elements
Horizontal/Vertical radiating element/sub- array spacing, dh /dv	0.5 of wavelength for H, 2.1 of wavelength for V	0.5 of wavelength for H, 2.1 of wavelength for V	0.5 of wavelength for H, 2.1 of wavelength for V

Number of element rows in sub-array, Msub	3	3	3
Vertical radiating element spacing in sub-array, dv,sub	0.7 of wavelength of V	0.7 of wavelength of V	0.7 of wavelength of V
Pre-set sub-array down-tilt, $\theta_{subtilt}$ (degrees)	3	3	3
Array Ohmic loss (dB) (Note 1)	2	2	2
Base station horizontal coverage range (degrees)	± 60	± 60	± 60
Base station vertical coverage range (degrees) (Notes 3, 4, 5)	90-100	90-100	90-100
Mechanical downtilt (degrees) (Note 4)	3	6	6

Note 1: The element gain in row 1.2 includes the loss given in row 1.8 and is per polarisation. This means that this parameter in row 1.8 is not needed for the calculation of the BS composite antenna gain and e.i.r.p.
 Note 2: For the small/micro cell case, 8×8 means there are 8 vertical and 8 horizontal radiating elements. For the extended AAS model case, 4×8 means there are 4 vertical and 8 horizontal radiating sub-arrays.
 Note 3: The vertical coverage range is given in global coordinate system, i.e. 90° being at the horizon.
 Note 4: The vertical coverage range in row 1.11 includes the mechanical downtilt given in row 1.12.
 Note 5: In sharing studies, the UEs that are below the base station vertical coverage range can be considered to be served by the "lower" bound of the electrical beam, i.e. beam steered towards the max coverage angle. A minimum BS-UE distance along the ground of 35 m should be used for urban/suburban and rural macro environments, 5 m for micro/outdoor small cell, and 2 m for indoor small cell/urban scenarios.

From the above macro BS antenna configuration, the maximum antenna gain of sub-array is 26.2 dBi when BS orientation is the same with its antenna main beam direction. Based on the defined base station vertical coverage range, the variation of the main beam within this range will result in different sidelobe effects in direction of altimeters. The varying antenna gain of MFCN BS is shown in Figure 175.

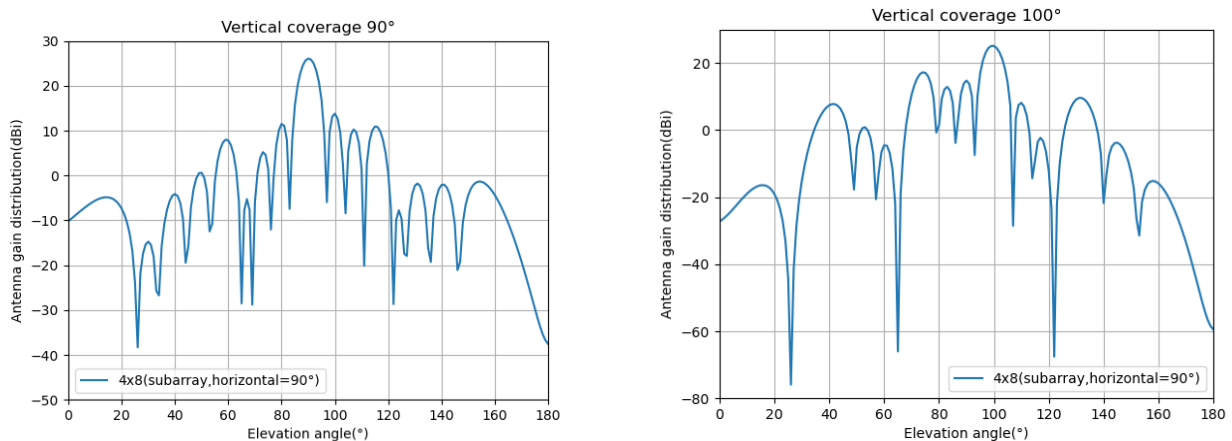

Figure 175: MFCN antenna gain (vertical cut)

A13.2.3 Radio Altimeter parameter

The RA antenna model is adopted from ITU-R report M.2319, its gain can be calculated as below.

$$Gain_{RA}(\theta) = -\frac{12}{(\theta_{3dB})^2} \theta^2 + Gain_{max}$$

Equation 39

Where the θ is the off-axis angle between RA main beam and the direction of RA-to-base station.

Table 121: Radio Altimeter antenna gain for sharing studies (Set 1)

Frequency range	Peak gain and 3 dB BW	Cable loss
3.4-4.1 GHz	0 dBi, 60° 3 dB-BW	3 dB

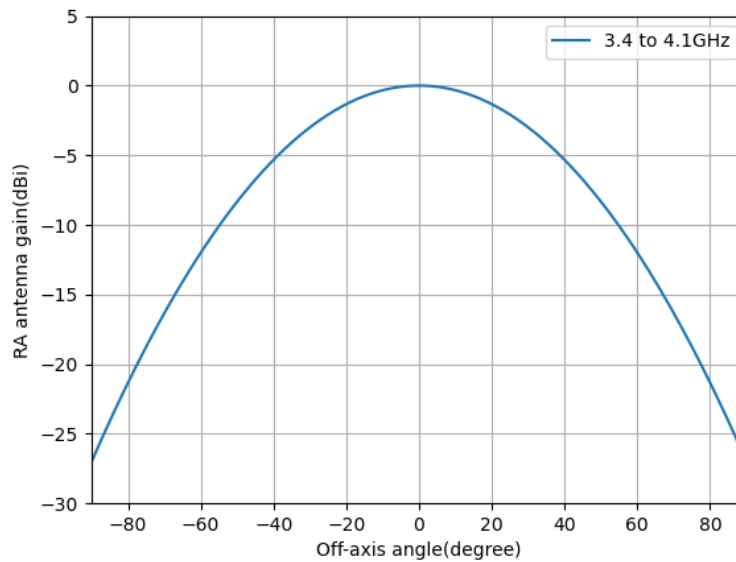

Figure 176: RA receiver gain

A13.2.4 Interference tolerance threshold

The breakpoints of different altimeter models for 3.4-3.7 GHz and 3.7-3.8 GHz band are provided with two altitudes, 200 feet and 1000 feet.

Table 122: UC 1 breakpoints between 3.4-3.8 GHz at 200 feet AGL in dBm/MHz

Altimeter model	3.4-3.7 GHz	3.7-3.8 GHz	Source
F	-21 (3.4 GHz Worst case sample)	-30 (3.8 GHz Worst case sample)	AVSI Report Vol 3 Figure 9-9
L	NB (> 0) (For 3700 MHz Percentile Criterion)	NB (> 0) (For 3750 MHz Percentile)	AVSI Report Vol 3 Table 8-8

Altimeter model	3.4-3.7 GHz	3.7-3.8 GHz	Source
	>2% Error)	Criterion >2% Error)	
T	NB (> -21.2) (For 3650 MHz Percentile Criterion >2% Error)	NB (> -21.0) (For 3750 MHz Percentile Criterion >2% Error)	AVSI Report Vol 3 Table 6-6
X	NB (> -20) (For 3650 MHz Percentile Criterion >2% Error)	NB (> -20) (For 3750 MHz Percentile Criterion >2% Error)	AVSI Report Vol 3 Table 8-10
U	NB (> -21.2) (For 3650 MHz NCD Criterion)	NB (> -21.0) (For 3750 MHz NCD Criterion)	AVSI Report Vol 3 Table 6-9
Y	NDA	-29 (For 3750 MHz)	AVSI Report Vol 1 Table 3-1
<p>Note: NB (> VALUE) refers to “No Breakpoint”, meaning normal RA operation up to the maximum 5G signal level tested, where VALUE is the maximum power tested, and the breakpoint would be higher than this level. This tested power level should not be considered as a breakpoint.</p> <p>Note: The breakpoints are converted to dBm/MHz</p> <p>Note: NCD refers to “no computed data”</p> <p>Note: NDA refers to “no data available,” meaning testing was not conducted for the frequency range.</p> <p>Note: Model L was not tested below 3.6 GHz. For this model it is assumed that the breakpoint power is equivalent for frequency bands farther from the 4.2 GHz band edge in the case that no data is available</p> <p>Note: For Model X, breakpoints are measured at AGL = 250 feet in AVSI Report Vol 3.</p> <p>Note: The breakpoints consider a percentile criterion of +/-2% error and an NCD criterion and do not consider a criterion of a mean error of 0.5%. The mean error deviation of 0.5% is more stringent than the Radio Altimeter height accuracy of +/-3%, across 95% of measured observations that is defined in RTCA DO-155 / EUROCAE ED-30 [22].</p>			

Table 123: UC 1 breakpoints between 3.4-3.8 GHz at 1000 feet AGL in dBm/MHz

Altimeter model	3.4-3.7 GHz	3.7-3.8 GHz	Source
F	-24 (3.7 GHz Worst case sample)	-34 (3.8 GHz Worst case sample)	AVSI Report Vol 3 Figure 9-10
L	NB (> 0) (For 3700 MHz Percentile Criterion >2% Error)	NB (> 0) (For 3750 MHz Percentile Criterion >2% Error)	AVSI Report Vol 3 Table 8-13
T	NB (> -21.9) (For 3650 MHz Percentile Criterion >2% Error)	NB (> -21.0) (For 3750 MHz Percentile Criterion >2% Error)	AVSI Report Vol 3 Table 6-18
X	NB (> -20.0) (For 3650 MHz Percentile Criterion >2% Error)	-24 (For 3750 MHz Percentile Criterion >2% Error at -40°C)	AVSI Report Vol 3 Table 8-14
U	NB (> -21.2) (For 3650 MHz NCD Criterion)	NB (> -21.0) (For 3750 MHz NCD Criterion)	AVSI Report Vol 3 Table 6-21

Altimeter model	3.4-3.7 GHz	3.7-3.8 GHz	Source
Y	NDA	-35 (For 3750 MHz)	AVSI Report Vol 1 Table 3-1
<p>Note: NB (> VALUE) refers to “No Breakpoint”, meaning normal RA operation up to the maximum 5G signal level tested, where VALUE is the maximum power tested, and the breakpoint would be higher than this level. This tested power level should not be considered as a breakpoint.</p> <p>Note: The breakpoints are converted to dBm/MHz</p> <p>Note: NCD refers to “no computed data”</p> <p>Note: NDA refers to “no data available,” meaning testing was not conducted for the frequency range.</p> <p>Note: Model L was not tested below 3.65 GHz. For these models it is assumed that the breakpoint power is equivalent for frequency bands farther from the 4.2 GHz band edge in the case that no data is available. This does not imply monotonic behaviour has been confirmed for these altimeters.</p> <p>Note: The breakpoints consider a percentile criterion of +/-2% error and an NCD criterion and do not consider a criterion of a mean error of 0.5%. The mean error deviation of 0.5% is more stringent than the Radio Altimeter height accuracy of +/-3%, across 95% of measured observations that is defined in RTCA DO-155 / EUROCAE ED-30 [22].</p>			

The interference tolerance threshold (ITT) of RA is defined for a specific altitude and frequency offset as the highest power for which performance is still acceptable, which means it can be used to evaluate the interference level from MFCN base station to the Radio Altimeter.

The ITT can be converted from provided RA breakpoints using Equation 1.

$$ITT = BP - BTI_f - EE_f - U\&T_f$$

Where:

- *ITT*: The interference tolerance threshold at the input to the Radio Altimeter Transceiver Receive Port. (dBm/MHz);
- *BP*: The breakpoint of the altimeter. (dBm/MHz);
- *BTI_f*: A *BP*-to-*ITT* backoff factor that accounts for the step-size used in the AVSI testing. (dB);
- *EE_f*: An experimental error factor. (dB);
- *U&T_f*: A unit-to-unit and temperature interference tolerance performance variation factor. (dB).

The necessary constants to convert the RA Breakpoints to ITT for the listed RA models are provided in Table 124.

Table 124: Constants for Equation 2 for Specified Altimeter Models

Parameter	Unit	Value
<i>BTI_f</i>	dB	1
<i>EE_f</i>	dB	1
<i>U&T_f</i>	dB	0 (for Altimeter model F, L and X) 4 (for Altimeter model T, U, and Y)

From the above analysis, the calculated ITT for 200 feet and 1000 feet is shown in Table 125 and Table 126 respectively.

Table 125: RA ITT between 3.4-3.8 GHz at 200 feet AGL in dBm/MHz

Altimeter model	3.4-3.7 GHz	3.7-3.8 GHz
F	-23	-32
L	NB	NB

Altimeter model	3.4-3.7 GHz	3.7-3.8 GHz
T	NB	NB
X	NB	NB
U	NB	NB
Y	NDA	-35

Table 126: RA ITT between 3.4-3.8 GHz at 1000 feet AGL in dBm/MHz

Altimeter model	3.4-3.7 GHz	3.7-3.8 GHz
F	-26	-36
L	NB	NB
T	NB	NB
X	NB	-26
U	NB	NB
Y	NDA	-41

A13.3 METHODOLOGY

A13.3.1 Interference scenario

The landing scenario which was agreed is considered as the coexistence scenario to evaluate the interference level from MFCN BS to RA.

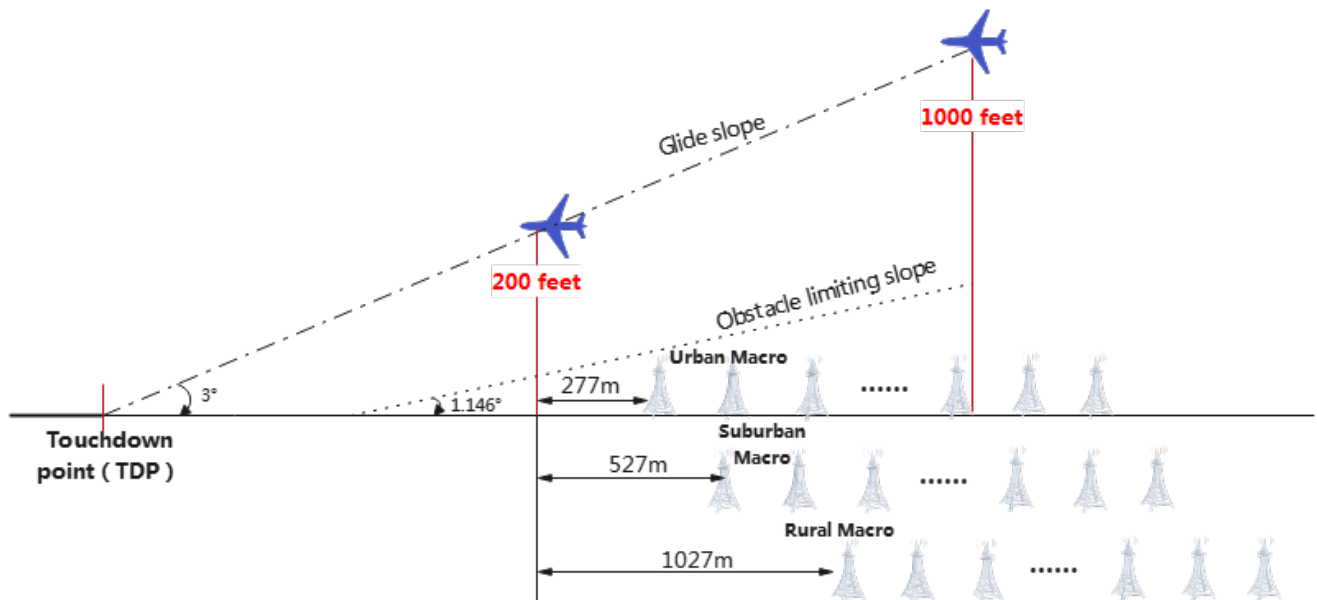

Figure 177: Interference scenario

The MFCN base stations are hypothetically distributed with specific inter-site distance along the runway. Considering the obstacle limitation slope, the minimum distance along the runway between RA at 200 feet AGL and different macro BS are presented in Table 127. For altimeter at 1000 feet AGL, there is no limitation.

Table 127: Minimum distance

Scenario	Minimum distance between RA at 200 feet AGL and BS (along the runway)
Urban	277 m
Suburban	527 m
Rural	1027 m

A13.3.2 Propagation loss

Considering the RA-to-BS path in the landing scenario is a Line-of-Sight (LOS) path, only free space pathloss is calculated in this sharing study. For two specific frequency ranges of 3.4-3.7 GHz and 3.7-3.8 GHz, intermediate frequency point 3.55 GHz and 3.75 GHz are selected to calculate propagation loss.

In addition, 3 dB polarisation loss is considered because of different antennas between MFCN BS and RA.

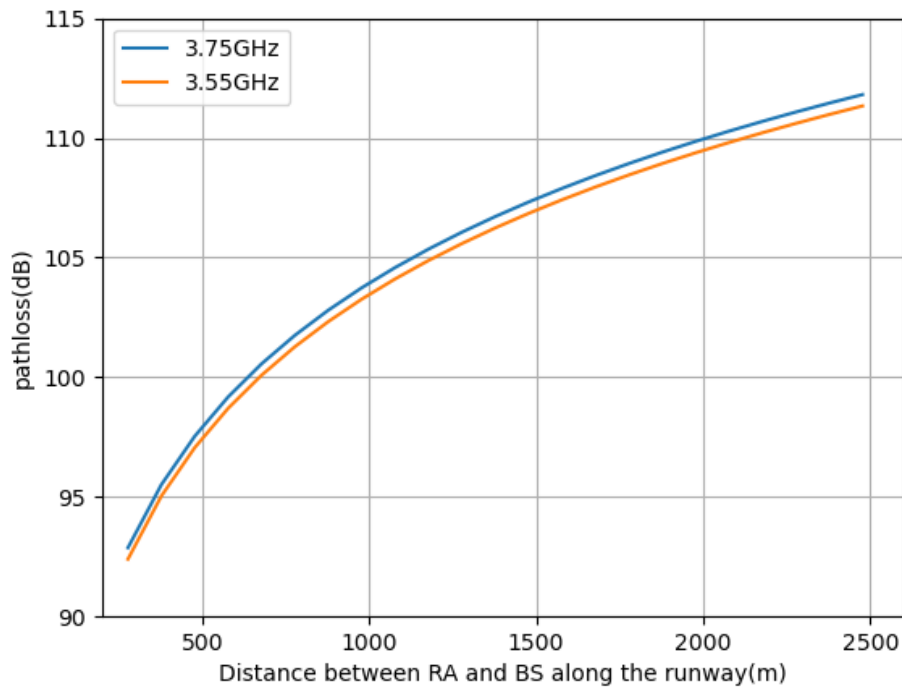

Figure 178: Path loss

A13.3.3 BS antenna gain

It should be noted that, three sectors for macro MFCN BS have different antenna gains in direction of altimeter due to different boresight. To evaluate the worst case, one of them is pointing towards RA, while the other two sectors have corresponding 120 degree offset. The impact of interference from BS to RA is calculated by the sum of three sectors emissions.

In our simulation, each sector has 3 served users that are located randomly within base station coverage range based on cell radius. Then the BS AAS beam steering is pointing to its served user direction respectively to calculate the sidelobe effect in the direction of the altimeter. The CDF distributions of antenna gain from the nearest BS deployed along the runway to altimeter is shown in the Figure 179.

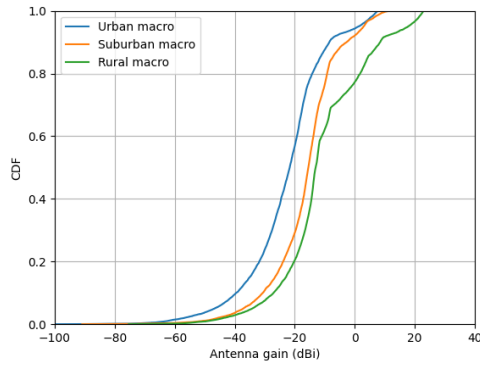

Figure 179: CDF of antenna gain from nearest BS to altimeter at 200 feet AGL

Both maximum sidelobe antenna gain and average sidelobe antenna gain of each BS in direction of altimeter have been considered in this study to evaluate worst case and actual situation respectively.

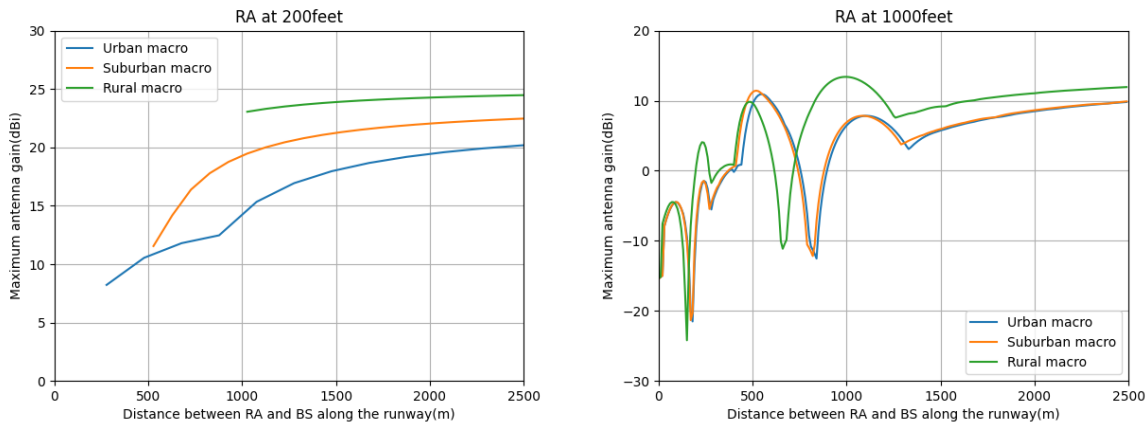

Figure 180: The maximum sidelobe antenna gain of each BS in direction of altimeter

A13.4 SIMULATION RESULTS

The interference level from MFCN BS to aircraft can be calculated by:

$$I = P + Gain_{BS} + Gain_{RA} - PL - CL$$

Equation 40

Where:

- I: The interference power at RA (dBm/100 MHz);
- P: The transmit power (TRP), dBm/100 MHz;
- Gain_{BS}: BS transmitter antenna gain in direction of altimeter taking into account the BS beamforming sidelobe effect, dBi;
- Gain_{RA}: RA receiver antenna gain in direction of base station taking into account the off-axis angle, dBi;
- PL: Propagation loss, dB;
- CL: RA Cable loss, 3 dB.

Generally, TRP can be derived from maximum *e.i.r.p.* level (78 dBm/100 MHz) and maximum antenna gain of MFCN BS.

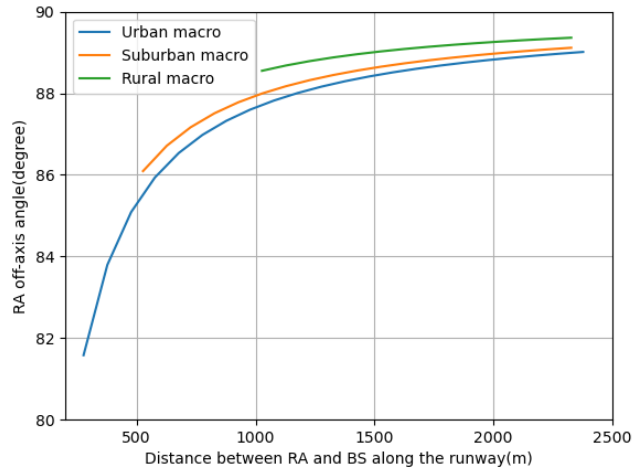

Figure 181: RA off-axis angle at 200 feet AGL

A13.4.1 Interference level

A13.4.1.1 Radio Altimeter at 200 feet height

Based on maximum transmit power and average sidelobe gain of MFCN BS, the interference power from different MFCN BS to RA in 3.4-3.7 GHz and 3.7-3.8 GHz band are separately displayed in Figure 182.

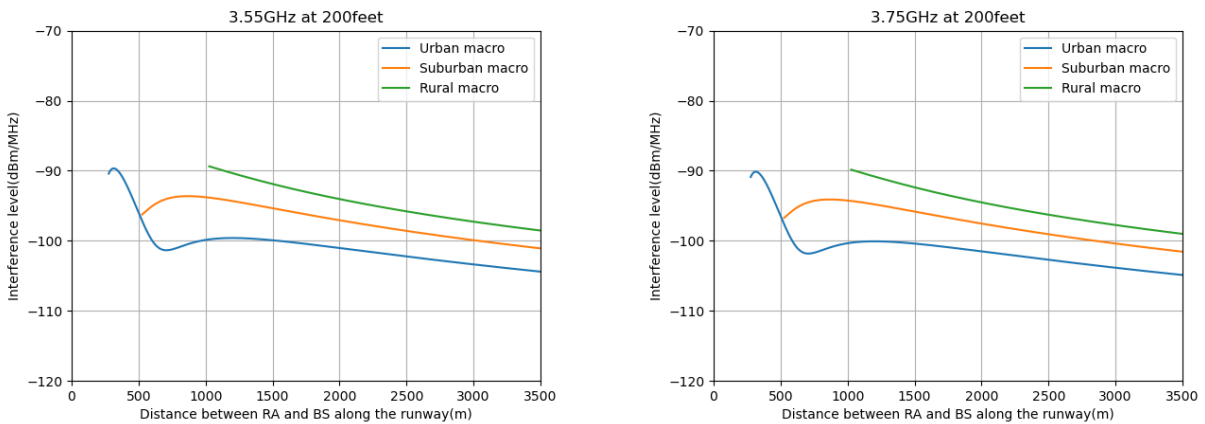

Figure 182: Actual interference level from MFCN BS to RA at 200 feet AGL

Based on maximum transmit power and maximum sidelobe gain of MFCN BS, the interference power from different MFCN BS to RA in 3.4-3.7 GHz and 3.7-3.8 GHz band are separately displayed in Figure 183.

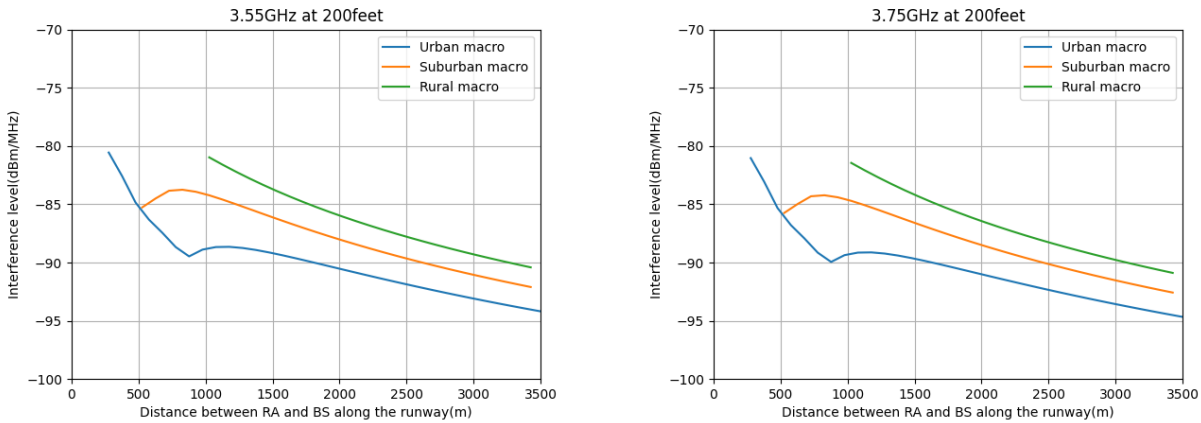

Figure 183: Maximum interference level from MFCN BS to RA at 200 feet AGL

As illustrated in above figure, the overall interference level tends to downward with distance increasing. The highest interference comes from the BS where it's near the aircraft along the runway but may not the nearest one. Table 128 shows the highest interference power from MFCN BS to RA.

Table 128: Highest interference power from MFCN BS to RA at 200 feet AGL in dBm/MHz

Scenarios	Based on BS average sidelobe gain		Based on BS maximum sidelobe gain	
	3.4-3.7 GHz	3.7-3.8 GHz	3.4-3.7 GHz	3.7-3.8 GHz
Urban	-89.66 (x = 305 m)	-90.13 (x = 305 m)	-80.56 (x = 277 m)	-81.04 (x = 277 m)
Suburban	-93.62 (x = 880 m)	-94.1 (x = 880 m)	-83.75 (x = 830 m)	-84.23 (x = 830 m)
Rural	-89.37 (x = 1027 m)	-89.85 (x = 1027 m)	-80.97 (x = 1027 m)	-81.45 (x = 1027 m)

The final interference power to the altimeter might come from aggregate emissions of all distributed MFCN base stations along the runway as shown in Figure 177. In order to analysis the aggregate interference from different number of MFCN base stations, the total number is set to 10 and 20 MFCN base stations respectively with inter-site distance is 600 m for urban/1200 m for suburban/2400 m for rural.

In order to assess the worst interference to RA, the aggregate interference is calculated by BS maximum sidelobe gain. Table 129 lists the aggregate worst interference power from different number of MFCN base stations in 3.4-3.7 GHz band to RA at 200 feet AGL.

Table 129: Aggregate interference power from MFCN BS to RA at 200 feet AGL in dBm/MHz

Scenarios	3.4-3.7 GHz		3.7-3.8 GHz	
	Aggregate interference From 10 BSs	Aggregate interference From 20 BSs	Aggregate interference From 10 BSs	Aggregate interference From 20 BSs
Urban	-78.56	-78.33	-79.04	-78.81
Suburban	-81.52	-81.35	-82	-81.83
Rural	-80.14	-79.62	-80.1	-79.57

It can be found that the aggregate interference does not significantly amplify as the number of base stations increasing due to additional propagation loss between distant BS and RA. In this case, although the highest interference is the main source of aggregate interference, the total interference of 10 MFCN BSs is chosen as a representative value at 200 feet AGL under the uncertainty number of base stations around the airport.

Radio Altimeter at 1000 feet height

There is no limitation to the minimum distance between BS and RA along the runway, therefore the nearest case is the BS directly below the aircraft. The sidelobe effect of MFCN BS antenna is the core influencing factor to interference level at 1000 feet height.

Based on maximum transmit power and average sidelobe gain of MFCN BS, interference power at RA varies as shown in Figure 184.

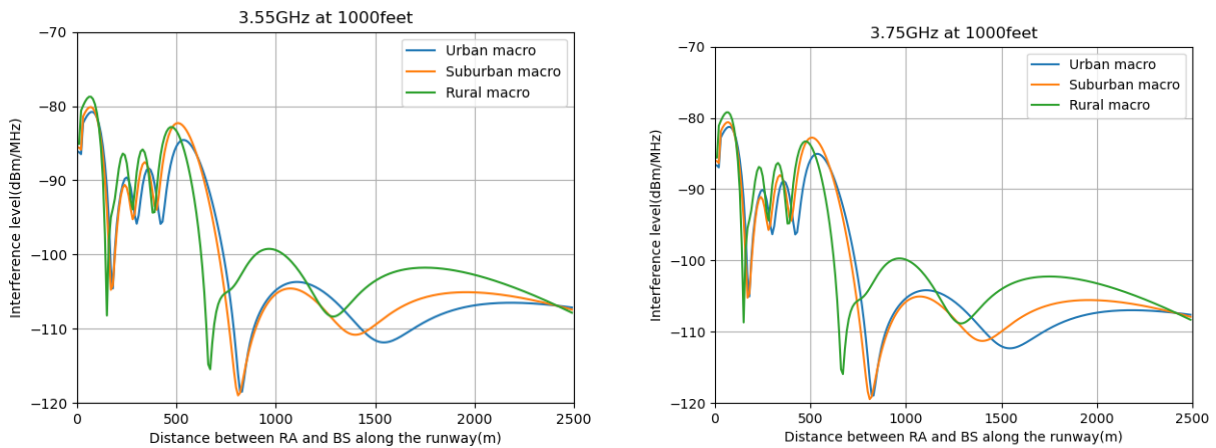

Figure 184: Actual interference level from MFCN BS to RA at 1000 feet AGL

Based on maximum transmit power and maximum sidelobe gain of MFCN BS, worst interference power at RA varies as shown in Figure 185.

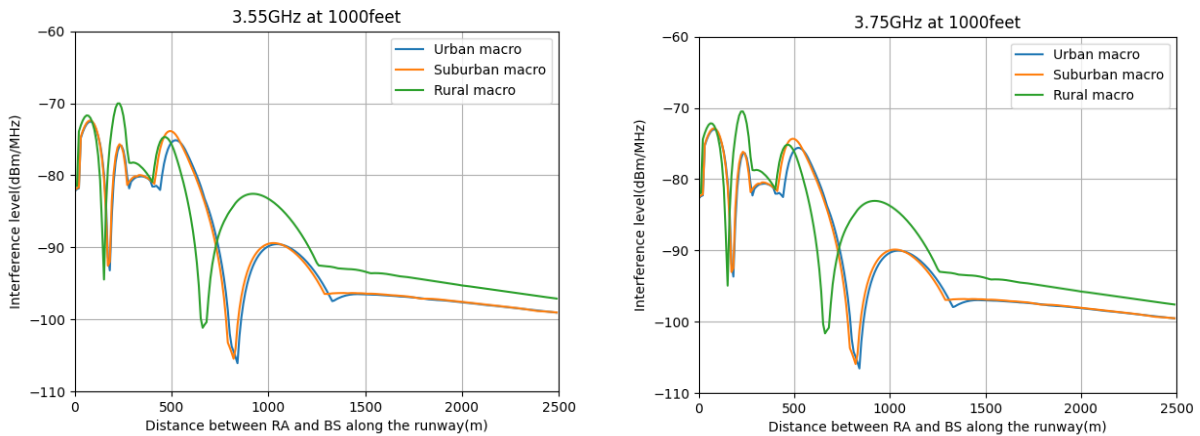

Figure 185: Maximum interference level from MFCN BS to RA at 1000 feet AGL

The highest interference comes from the BS where it's near the aircraft along the runway but not the nearest one. Table 130 presents the highest interference power from MFCN BS to RA.

Table 130: Highest interference power from MFCN BS to RA at 1000 feet AGL in dBm/MHz

Scenarios	Based on BS average sidelobe gain		Based on BS maximum sidelobe gain	
	3.4-3.7 GHz	3.7-3.8 GHz	3.4-3.7 GHz	3.7-3.8 GHz
Urban	-80.79 (x = 70 m)	-81.27 (x = 70 m)	-72.55 (x = 80 m)	-73.02 (x = 80 m)
Suburban	-80.13 (x = 70 m)	-80.61 (x = 70 m)	-72.4 (x = 80 m)	-72.87 (x = 80 m)
Rural	-78.75 (x = 70 m)	-79.22 (x = 70 m)	-70.02 (x = 230 m)	-70.5 (x = 230 m)

In order to assess the worst interference to RA, the aggregate interference is calculated by BS maximum sidelobe gain. Through analysing the interference result from different number of base stations at 200 feet, the case of 10 MFCN base stations can be also applicable to evaluate representative interference power to altimeter at 1000 feet under the uncertainty number of base stations around the airport.

Table 131: Aggregate interference power from 10 MFCN BSs to RA at 1000 feet AGL in dBm/MHz

Scenarios	3.4-3.7 GHz	3.7-3.8 GHz
Urban	-72.18	-72.65
Suburban	-72.33	-72.81
Rural	-69.99	-70.47

A13.4.2 Margin

From Table 129, Urban as the strictest scenario for 200 feet altitude is chosen, its aggregate interference power from 10 MFCN BSs have substantial margin for different altimeter models when compared with RA ITT between 3.4 GHz and 3.8GHz band which is calculated in Table 125. The detail values are shown in Table 132.

Table 132: Margin between 3.4-3.8 GHz at 200 feet AGL in dB

Altimeter model	3.4-3.7 GHz	3.7-3.8 GHz
F	56.56	47.04
L	NB	NB
T	NB	NB
X	NB	NB
U	NB	NB
Y	NDA	44.04

From Table 131, Rural is chosen as the strictest scenario for 1000 feet altitude, the margin for different Radio Altimeter models and different frequency ranges are summarised as below Table 133.

Table 133: Margin between 3.4-3.8 GHz at 1000 feet AGL in dB

Altimeter model	3.4-3.7 GHz	3.7-3.8 GHz
F	43.99	34.47
L	NB	NB
T	NB	NB
X	NB	44.47
U	NB	NB
Y	NDA	29.47

A13.5 CONCLUSION

The interference levels from different MFCN base stations to altimeter at a fixed height of 200 feet and 1000 feet are derived based on common maximum output power (e.i.r.p) of 78 dBm/100 MHz in Europe, considering both maximum sidelobe antenna gain and average sidelobe antenna gain of each BS. 10 MFCN BSs are chosen to calculate the representative aggregate interference power under the uncertainty number of base stations around the airport. Through analysing the maximum sidelobe effect of MFCN BS antenna that the main beam is pointing towards its served UE, the worst interference result comes from rural scenario where BSs are deployed outside the OLS (distance to TDP \geq 2190 m), but still display 29 dB margin. If the average sidelobe antenna gain which is more in line with actual situation has taken into account, the margin could be improved. Therefore, for the base station locations, altimeters models, and operational scenarios studied, the coexistence between MFCN BS and altimeter is feasible for both 200 feet and 1000 feet height for Set 1 parameter values.

ANNEX 14: RADIO ALTIMETER RISK ASSESSMENT CONSIDERATIONS

A14.1 IN-FLIGHTS (DEPENDING ON CATEGORIES)

A14.2 CLASSIFICATION OF FAILURE CONDITIONS IN AVIATION

For the assessment of risks associated with failures of equipment or systems, or malfunctioning thereof, aviation has a well-established classification scheme with defined criteria. For EASA, these have been specified in the Acceptable Means of Compliance to the Certification Specifications (e.g. CS 25-1309 for large aeroplanes). The FAA criteria are similar. For a better understanding of the description of interference scenarios, it is essential to obtain an appreciation of the classification scheme.

Manufacturers of aircraft (formally the Type Certificate Holders) perform the initial assessment of the risks and categorise and classify every possible failure that can be foreseen to occur in the lifetime of the entire fleet of aircraft of a particular design. Whenever a change is introduced to an aircraft, this process is repeated for the risks that may be introduced by the change.

The assessment made by the manufacturers is then shared with the competent authority for the State of Design for approval. In the case of EU based manufacturers, this is EASA. In most cases, the assessment is also shared with foreign authorities, who validate the certification of any product before accepting it to be registered in their country or region.

In performing the classification of failure conditions, the aircraft manufacturers consider the following:

- Effect on the aeroplane;
- Effect on occupants, excluding the flight crew (pilots);
- Effect on the flight crew.

Table 134 is taken from the AMC to CS 25.1309 of CS 25 at amendment 26, shows the relationship between the severity of the effects and the classification of the failure conditions:

Table 134:

Severity of the Effects	Effect on Aeroplane	No effect on operational capabilities or safety	Slight reduction in functional capabilities or safety margins	Significant reduction in functional capabilities or safety margins	Large reduction in functional capabilities or safety margins	Normally with hull loss
	Effect on Occupants excluding Flight Crew	Inconvenience	Physical discomfort	Physical distress, possibly including injuries	Serious or fatal injury to a small number of passengers or cabin crew	Multiple fatalities
	Effect on Flight Crew	No effect on flight crew	Slight increase in workload	Physical discomfort or a significant increase in workload	Physical distress or excessive workload impairs ability to perform tasks	Fatalities or incapacitation
Classification of Failure Conditions		No Safety Effect	Minor	Major	Hazardous	Catastrophic

There is also a relationship between the classification of failure effects and the allowable probability of such a failure occurring. It is obvious that failures that have a negligible effect on safety are allowed to occur more often than failures that have more severe effects. The relationship between the classification of failures and the allowable probability is shown Table 135:

Table 135:

Classification of Failure Conditions	No Safety Effect	Minor	Major	Hazardous	Catastrophic
Allowable Qualitative Probability	No Probability Requirement	<-Probable->	<--Remote-->	Extremely <-----> Remote	Extremely Improbable
Allowable Quantitative Probability: Average Probability per Flight Hour on the Order of:	No Probability Requirement	<-----> <10 ⁻³ Note 1	<-----> <10 ⁻⁵	<-----> <10 ⁻⁷	<10 ⁻⁹
Note 1: A numerical probability range is provided here as a reference. The applicant is not required to perform a quantitative analysis, nor substantiate by such an analysis, that this numerical criteria has been met for minor failure conditions. Current transport category aeroplane products are regarded as meeting this standard simply by using current commonly-accepted industry practice.					

For catastrophic failure conditions additional criteria apply ensuring that:

- 1 No single failure will result in a catastrophic failure condition; and
- 2 Each catastrophic failure condition is extremely improbable.
- 3 Given that a single latent failure has occurred on a given flight, each catastrophic failure condition, resulting from two failures, either of which is latent for more than one flight, is remote.

For completeness, it is worth mentioning that separate development assurance criteria apply for items like software and complex airborne electronic hardware, where it is not possible to quantify the probability of failures. These items need to be developed in accordance with specific processes for the item to comply with Development Assurance Levels.

Aircraft in service are continuously being monitored to ensure their continued airworthiness. If the continued airworthiness cannot be assured, for example if the probability associated with a given failure condition is not being met, corrective actions are taken to rectify the problem and mitigate the risk.

Aviation authorities are bound by specific rules related to mandating operators to implement any corrective action. This is to protect the industry against abuse of power. In general, aviation authorities may take regulatory steps to mandate corrective action when the failure classification is assessed as either Hazardous or Catastrophic, but there are exceptions for specific cases.

A14.2.1 Commercial Aircraft

It is difficult to generalise the effect of interference on aircraft without entering into specific details as the design and complexity of aircraft vary considerably. Consequently, the effect of interference may vary as well.

For the cruise phase, two systems may be affected by interference of the Radio Altimeter:

Firstly, a system that alerts against imminent risk of collision with terrain and obstacles. This system, referred to as the Terrain Awareness and Warning System (TAWS), relies heavily on inputs obtained from the Radio Altimeter. Early versions of this system were notoriously unreliable, and it has taken decades for flight crews to gain confidence in the appropriateness of the alerts that it provides. Regrettably many lives have been lost that could have been saved if the pilots had not questioned the proper functioning of this system. The current TAWS systems are very dependable. The failure condition associated with erroneous alerting of this system is MAJOR.

The second system that may be affected is a system that alerts against imminent risk of collision with other aircraft. This Traffic Collision Avoidance System (TCAS) is desensitised at lower altitudes to prevent it from instructing an instruction to the flight crew to descend into the ground and to avoid undue alerts when the aircraft is in final approach. The system relies on inputs from the Radio Altimeter to determine when it should be desensitised. The failure condition associated with erroneous operation of this systems is MAJOR.

A14.2.2 Regional, Business Aviation, and General Aviation Aircraft

Regional aircraft used for short haul commercial transport are generally equipped with the same systems described above.

The high end of business aviation is also equipped with similar systems, the low end may be less well equipped, although an increasing number of aircraft are benefitting from the availability and affordability of such safety enhancing systems.

General aviation is generally less dependent on the use of Radio Altimeters and often not equipped with such systems.

A14.2.3 Helicopter

Helicopters may utilise Radio Altimeters for various purposes, including for functions that allow the helicopter to hover on the autopilot. In general, the failure classifications associated with these functions are no more than MAJOR.

There is one exception. More recent helicopters that are designed to perform search and rescue (SAR) operations are equipped with systems that allow the automatic execution of SAR flight patterns. These systems rely on the input from Radio Altimeters to maintain a given altitude. The manufacturers' assessment of the effect of erroneous Radio Altimeter behaviour on these systems is HAZARDOUS.

A14.2.4 Landing and take off (depending on categories)

A14.2.4.1 Commercial Aircraft

On modern large aeroplanes, the landing is not often executed manually anymore. The majority of landings is executed by the automation. And even if the landing is executed manually, due to the size of the aircraft, the flight crews fully rely on the data provided by the Radio Altimeter to understand the actual height above the terrain or the runway.

The main concern with aircraft being provided with erroneous Radio Altimeter data or loss of Radio Altimeter data is with the execution of the flare. The flare is the pitch up movement of the aircraft just before touchdown that reduces the vertical speed and ensures a 'soft' touch down. The data provided by the Radio Altimeter is essential to determine the height above the runway at which the flare is initiated.

There are three possible failure cases related to the execution of the flare:

- The flare is executed prematurely. An example of this is an accident with a Boeing 737 operated by Turkish Airlines on an approach to Schiphol Airport near Amsterdam. Faulty Radio Altimeter information caused the autothrottle, the system that controls the power provided by the engines, to assume that the flare had initiated and retarded the throttles to the idle position. The aircraft subsequently lost airspeed, stalled and crashed into a field short of the runway, with multiple fatalities;
- The flare is not executed. In a scenario where the Radio Altimeter would fail such that it would provide a height above terrain that is higher than the actual height, the aircraft will not flare and hit the runway at a much higher vertical speed than its undercarriage can sustain;
- The aircraft enters a long flare. In this particular scenario, the aircraft initiates but does not complete the flare or it executes the flare too slowly. The effect is that it continues to fly past the point where it should have landed, and the remaining length of the runway may be too short to come to a full stop.

All three scenarios could be caused by erroneous Radio Altimeter. Some aircraft have sophisticated protection mechanisms that protect against a premature or long flare, but many don't. The risks associated with the impact of erroneous behaviour of the Radio Altimeter or the loss of Radio Altimeter data ranges from MAJOR on aircraft that have implemented protections, to CATASTROPHIC on those that don't.

The Radio Altimeter often also provides inputs to systems to determine whether the aircraft is actually on the ground. In aviation terms, this is the 'Weight on Wheels' signal. Many aircraft rely on inputs of a variety of sensors to make this determination, but in some commonly used aircraft, the simultaneous loss of all Radio Altimeters (NCD) causes various systems to assume that the aircraft is actually flying at or above 2500 feet height above terrain. Where this occurs, the impact could be considerable:

- Means to brake the aircraft after landing or during a rejected take off, such as ground spoilers and thrust reversers may not deploy. On wet or contaminated runways, the associated failure effect is CATASTROPHIC;
- Means to provide lateral control of the aircraft during the roll-out or take off roll may not have sufficient authority to ensure that the aircraft remains on the runway. The associated effect is again CATASTROPHIC.

Other systems that are affected have associated failure classifications ranging from MAJOR to HAZARDOUS.

A14.2.5 Regional, Business Aviation, and General Aviation Aircraft

The more sophisticated larger regional aircraft that are used for short haul commercial transport and high end business aviation aircraft may suffer from the same effects as described above, in particular in relation to the flare. Protections for premature flare and long flare are uncommon in these designs. The failure conditions again being potentially CATASTROPHIC.

To what extent the erroneous data or the loss of Radio Altimeter affects the approach, take off and landing in other ways is still subject of investigation.

The smaller regional aircraft and the lower end of business aviation may be less susceptible to erroneous Radio Altimeter data or loss of such data as the level of automation is lower and they are not equipped to perform the most critical and demanding automated landings. Consequently, the associated failure classification is MAJOR, or occasionally HAZARDOUS at most.

In general aviation, most, if not all landings are executed manually. Due to the smaller size of the aircraft and the fact that the landing is almost exclusively executed in visual conditions, assessing the height above terrain is not a major concern.

More recently, a low number of general aviation aircraft have been equipped with systems that will enable the aircraft to perform an automated landing in the case that the pilot is incapacitated. Like larger commercial aeroplanes, these rely on Radio Altimeter inputs to execute the flare and landing. The number of aircraft equipped with these systems however is low, and the probability of pilot incapacitation is also relatively low. Hence these systems have not been assessed so far.

A14.2.6 Helicopter

Landings with helicopters are executed manually by the pilot. A Radio Altimeter is an aid to the pilot in the execution of the approach and landing, but the criticality of the function is lower than on larger fixed wing aircraft where the approach and landing is executed automatically. In general, the failure condition associated with erroneous Radio Altimeter data, or the failure thereof is not more severe than MAJOR.

A special consideration for larger rotorcraft is the execution of the so-called CAT A departure procedure. The execution of this procedure, which includes a few points at which the pilot would have to make critical decisions relies heavily on data provided by the Radio Altimeter. Erroneous output from the Radio Altimeter is classified as MAJOR to HAZARDOUS.

ANNEX 15: LIST OF REFERENCES

- [1] AVSI AFE 76s2 Report, "Derivation of Radar Altimeter Interference Tolerance Masks - Volume I, "Introduction, Test Procedures, and Fundamental Test Results" (6 December 2021)
- [2] AVSI AFE 76s2 Report, "Derivation of Radar Altimeter Interference Tolerance Masks - Volume II, "Spurious Test Results" (22 December 2021)
- [3] AVSI AFE 76s2 Report, "Derivation of Radar Altimeter Interference Tolerance Masks - Volume III, "Manufacturer-Provided Test Results" (9 April 2022)
- [4] ERC Recommendation 74-01: "Unwanted Emissions in the Spurious Domain, approved 1997, corrected May 2022"
- [5] [CEPT Report 67](#): "Report A from CEPT to the European Commission in response to the Mandate "to develop harmonised technical conditions for spectrum use in support of the introduction of next-generation (5G) terrestrial wireless systems in the Union"
Review of the harmonised technical conditions applicable to the 3.4-3.8 GHz ('3.6 GHz') frequency band", approved July 2018
- [6] [Decision \(EU\) 2019/235](#) Commission Implementing Decision (EU) 2019/235 of 24 January 2019 on amending Decision 2008/411/EC as regards an update of relevant technical conditions applicable to the 3400-3800 MHz frequency band
- [7] [ECC Report 281](#): "Analysis of the suitability of the regulatory technical conditions for 5G MFCN operation in the 3400-3800 MHz band", approved July 2018
- [8] [ECC Decision \(11\)06](#): "Harmonised frequency arrangements and least restrictive technical conditions (LRTC) for mobile/fixed communications networks (MFCN) operating in the band 3400-3800 MHz", approved December 2011, latest amended October 2018
- [9] ECC (22)039, annex 18 and annex 19
- [10] EEC (European Electronic Communications Code)
- [11] EUROPEAN COMMISSION RADIO SPECTRUM POLICY GROUP State of play regarding award of 5G pioneer band ([RSPG24-002](#))
- [12] [ECO Report 03](#): "The Licensing of "Mobile Bands" in CEPT"
- [13] ETSI EN 301 908-24 V15.1.1 (2023-09): "IMT cellular networks; Harmonised Standard for access to radio spectrum; Part 24: New Radio (NR) Base Stations (BS) Release 15"
- [14] ITU Radio Regulations, Edition of 2020
- [15] [ECC Report 358](#): "In-band and adjacent bands sharing studies to assess the feasibility of the shared use of the 3.8-4.2 GHz frequency band by terrestrial wireless broadband systems providing local-area (i.e. low/medium power) network connectivity", approved June 2024
- [16] ICAO Annex 6 to the Convention on International Civil Aviation
- [17] Regulation (EU) No 965/2012
- [18] European Union Aviation Safety Agency (EASA) CS-ACNS issue 4
- [19] ETSO-C87A
- [20] EUROCAE document ED-30
- [21] ITU-R Recommendation M.2059: "Operational and technical characteristics and protection criteria of Radio Altimeters utilizing the band 4 200-4 400 MHz"
- [22] ITU-R Report M.2319: "Compatibility analysis between wireless avionic intra-communication systems and systems in the existing services in the frequency band"
- [23] RTCA, Inc. Paper No. 274-20/PMC-2073, "Assessment of C-Band Mobile Telecommunications Interference Impact on Low Range Radar Altimeter Operations" (October 7, 2020)
- [24] ICAO document 9781 AN/957, "Handbook on Radio Frequency Spectrum Requirements for Civil Aviation," Volume I, "ICAO spectrum strategy, policy statements and related information" (2023)
- [25] RTCA DO-155
- [26] ICAO Annex 14 to the Convention on International Civil Aviation
- [27] Working Party 5D Chairman's Report, "CHARACTERISTICS OF TERRESTRIAL COMPONENT OF IMT FOR SHARING AND COMPATIBILITY STUDIES IN PREPARATION FOR WRC-23", Annex 4.4 to Document 5D/716-E
- [28] Recommendation ITU-R F.1336

- [29] Report ITU-R M.2292: “Characteristics of terrestrial IMT-Advanced systems for frequency sharing/interference analyses”
 - [30] Recommendation ITU-R P.2109: “Prediction of building entry loss”
 - [31] Recommendation ITU-R M.2101: “Modelling and simulation of IMT networks and systems for use in sharing and compatibility studies“
 - [32] Annex 20 to WG Spectrum Aspects and WRC-23 Preparations Chairman’s Report on uncorrelated beamforming
 - [33] 3GPP TS 38.101
 - [34] [3GPP TR 38.803](#)
 - [35] [SE21\(22\)042: “OoB measurement of a 26 GHz 5G system”](#)
 - [36] ETSI TS 138 104, section 9.7.4, “OTA operating band unwanted emissions”,
 - [37] ETSI TS 103 636-2 v1.4.1
- ETSI TS 103 636-2 V1.5.1 (2024-03): “DECT-2020 New Radio (NR); Part 2: Radio reception and transmission requirements; Release 1”
- [38] ECC PT1(23)221
 - [39] ECC PT1(23)135
 - [40] Recommendation ITU-R M.2150
 - [41] [ECC Report 309](#): “Analysis of the usage of aerial UE for communication in current MFCN harmonised bands”, approved July 2020
 - [42] Recommendation ITU-R P..525 “Calculation of free space attenuation” https://www.itu.int/dms_pubrec/itu-r/rec/p/R-REC-P.525-4-201908-III-PDF-E.pdf
 - [43] [CEPT Report 88](#): “Report from CEPT to the European Commission in response to the Mandate on shared use of the 3800-4200 MHz frequency band by low/medium power terrestrial wireless broadband systems (WBB LMP) providing local-area network connectivity”